

AN ABSTRACT OF THE THESIS OF

Samantha Sheehy for the degree of Master of Science in Geography presented on June 8, 2006.

Title: Exotic Plant Species Dynamics from 1994 to 2005 on Road Networks in Forested Landscapes of Western Oregon.

Abstract approved:

Julia A. Jones

Although the Pacific Northwest has the least proportion of non-native plant species in relation to other regions of North America, exotic species continue to spread into mountainous areas, including the Cascade Range. In a forested landscape, road networks can act as corridors for exotic plant dispersal and establishment, helping species to overcome environmental barriers to expansion. Observation of the expanding, contracting, and possibly static spatial patterns of exotic species distributions over an extended time period can provide insight into biogeographical factors influencing invasion.

The objective of this study was to compare the results of a road survey conducted in 2005 to a previous road survey conducted in 1994, in order to describe the current distribution and eleven-year change in the spatial pattern of eight exotic plant species in and around H.J. Andrews Experimental Forest in Blue River, Oregon, and to highlight the role of road networks and timber harvest activity in facilitating exotic plant spread over time. Specific objectives were to (1) describe the distribution

in 2005 of eleven exotic species on the road network, (2) quantify the change in distribution from 1994 to 2005 of eight exotic species on the road network, (3) determine the spatial pattern of distributions in 2005 as well as the change in spatial pattern from 1994 to 2005, (4) analyze species distributions and change over time in relation to four environmental and four human-influenced landscape factors, and (5) assess the degree to which landscape factors are correlated on the road network.

Presence/absence and relative abundance on the road network was mapped using GIS. Spatial pattern was characterized using standardized semivariograms. CART (classification analysis and regression tree) modeling was used to evaluate landscape factors and species distributions.

Target species covered as little as 3.7% (*C. maculosa* - spotted knapweed) to as much as 90.2% (*H. perforatum* – St. John's wort) of the entire network sampled in 2005. Species increased on much as 14.7% of the road network (*C. leucanthemum* – ox eye daisy) and decreased on much as 20% of the road network (*C. vulgare* – bull thistle) from 1994 to 2005 on the roads at the H.J. Andrews Forest. Spatial analysis of standardized semivariograms for exotic species distributions in 2005 did not reveal any preferred scale of patch size for the species evaluated, and species distributions were heterogeneously distributed at the landscape scale. In CART analysis, elevation was the landscape factor most associated with exotic species presence/absence in 2005, as well as increase in exotic species from 1994 to 2005. Age of adjacent clearcut patch was associated with decrease in exotic species from 1994 to 2005. However, the high degree of correlation between landscape factors on the road

network makes direct causal relationships between exotic species distributions and single landscape attributes difficult to isolate.

The results of this study suggest that, for some species, exotic species distributions are closely related to areas of the network that had been clearcut in the 1950s and 1970s, and that change in exotic species distributions over time is a function of dispersal processes along road corridors subjected to high vehicle traffic, as well as changes in light availability due to closing canopy cover in aging clearcut patches. Hotspots of exotic plant diversity and abundance also occurred at sites that receive traffic from researchers, public visitors, and in some cases in conjunction with recent logging treatments. This paper outlines a conceptual model of exotic plant invasion over time as a function of explanatory landscape factors, both environmental and anthropomorphic in nature, which are correlated in space and heterogeneously distributed across the landscape.

©Copyright Samantha Sheehy
June 8, 2006
All Rights Reserved

Exotic Plant Species Dynamics from 1994 to 2005 on Road Networks in Forested
Landscapes of Western Oregon

by
Samantha Sheehy

A THESIS

submitted to

Oregon State University

in partial fulfillment of
the requirements for the
degree of

Master of Science

Presented June 8, 2006
Commencement June 2007

Master of Science thesis of Samantha Sheehy presented on June 8, 2006.

APPROVED:

Major Professor, representing Geography

Chair of the Department of Geosciences

Dean of the Graduate School

I understand that my thesis will become part of the permanent collection of Oregon State University libraries. My signature below authorizes release of my thesis to any reader upon request.

Samantha Sheehy, Author

ACKNOWLEDGEMENTS

First and foremost, I'd like to thank my advisor, Dr. Julia Jones, for her inspiration and guidance throughout my graduate school experience. She has helped foster my interest in everything from landscape ecology and exotic plants to science-fiction books and volunteer work. Julia helped secure funding which made my extensive summer field work possible, encouraged me during difficult times both personally and academically, and welcomed me warmly on my arrival to the geosciences department and to the Pacific Northwest. She is brilliant, and generous, and I am so lucky to have worked with her during these past two years.

I would also like to thank the members of my graduate committee, Dr. Dawn Wright and Dr. Becky Kerns for their participation and assistance. I learned much about invasive plant biology from Becky, and Dawn gave me the opportunity to serve as the Campus GIS Assistant, a role which helped develop both my communication skills and my technological knowledge.

This research would not be possible without the previous work of Laurie Parendes and Nicholas Watterson, who answered numerous emails and were generous with their time and their data. Dr. Fred Swanson provided invaluable information about the landscape history of the H.J. Andrews Forest, Brandt Balgooyen helped me design and carry out my statistical analysis, and George Lienkaemper helped dynamically segment the road network not once but four times over. My fellow graduate students and friends, especially Kristel Fesler, Isaac Daniel, Barbara Geren, Preeti Tuladhar, Matt Wharton, Chris Merideth and Sean Orton have made my time at Oregon State a wonderful, blissful experience. I thank Brent Boehlert for holding my

hand through everything, from start to finish, and my parents for not dropping dead when I told them I was moving to Oregon to study plants and maps. Finally, this research was supported by a National Science Foundation grant to the H.J. Andrews Long-term Ecological Research (LTER) site, with additional support provided by the 2006 TRIADS Service Scholarship and the Department of Geosciences Arthur Parenzin Fellowship.

TABLE OF CONTENTS

	<u>Page</u>
INTRODUCTION.....	1
Objectives/Hypotheses.....	3
Landscape History.....	5
Previous Exotic Species Studies at the H.J. Andrews.....	7
Conceptual Framework of Invasion over Time.....	14
	.
METHODS.....	17
Study Area.....	17
Field Sampling.....	19
GIS Analysis.....	24
Geostatistical Analysis.....	27
Statistical Analysis.....	29
Evaluation of Exotic Species Diversity.....	31
RESULTS.....	33
Spatial Distribution of Exotic Species in 2005.....	33
Relative Abundance of Selected Species.....	59
Analysis of Spatial Pattern in 2005.....	65
Change in Species Distributions from 1994 to 2005 at the H.J Andrews.....	72
Change in Spatial Distribution Pattern from 1994 to 2005.....	82
Relationship Between Exotic Species Presence and Landscape Factors.....	109
CART Analysis Results for the Relationship Between Landscape Variables and Exotic Species in 2005.....	122
CART Analysis Results for the Relationship Between Landscape Variables and Increase in Exotic Species from 1994 to 2005.....	144
CART Analysis Results for the Relationship Between Landscape Variables and Decrease in Exotic Species from 1994 to 2005.....	158
Summary of CART Results.....	168

TABLE OF CONTENTS (Continued)

	<u>Page</u>
Correlations Between Landscape Factors.....	176
Evaluation of Exotic Species Diversity.....	182
DISCUSSION.....	189
Spatial Distribution Patterns of Exotic Species in 2005.....	189
Spatial Pattern of Distributions in 2005.....	206
Change in Species Distributions and Spatial Pattern from 1994 to 2005.....	208
Landscape Variables Associated with Presence in 2005.....	212
Landscape Variables Associated with Increase from 1994 to 2005.....	214
Landscape Variables Associated with Decrease from 1994 to 2005.....	217
Correlations Between Landscape Variables.....	217
Support of Hypotheses.....	219
Total Exotic Occurrence and Diversity.....	222
CONCLUSION.....	226
LITERATURE CITED.....	227
APPENDIX.....	235

LIST OF FIGURES

<u>Figure</u>	<u>Page</u>
1: Conceptual model of the link between landscape factors and the presence of exotic plant species in a forested landscape.....	15
2: Location of the H.J. Andrews Experimental Forest, Blue River, Oregon.....	18
3: Roads sampled in the 2005 Survey in and around the H. J. Andrews Experimental Forest.....	20
4: Roads in the H.J. Andrews and Deer Creek Basin areas that were used in the analysis of spatial pattern in 2005.....	28
5: Roads in the H.J. Andrews and Deer Creek Basin areas that were used in the evaluation of spatial pattern change from 1994 to 2005.....	29
6: Distribution of <i>H. perforatum</i> at the H.J. Andrews and Deer Creek drainage area.....	35
7: Distribution of <i>C. leucanthemum</i> at the H.J. Andrews and Deer Creek drainage area.....	37
8: Distribution of <i>L. muralis</i> at the H.J. Andrews and Deer Creek drainage area.....	39
9: Distribution of <i>C. vulgare</i> at the H.J. Andrews and Deer Creek drainage area.....	42
10: Distribution of <i>C. scoparius</i> at the H.J. Andrews and Deer Creek drainage area.....	44
11: Distribution of <i>S. jacobaea</i> at the H.J. Andrews and Deer Creek drainage area.....	46
12: Distribution of <i>C. arvensis</i> at the H.J. Andrews and Deer Creek drainage area.....	48
13: Distribution of <i>B. sylvaticum</i> at the H.J. Andrews and Deer Creek drainage area.....	51
14: Distribution of <i>D. purpurea</i> at the H.J. Andrews and Deer Creek drainage area.....	53

LIST OF FIGURES (Continued)

<u>Figure</u>	<u>Page</u>
15: Distribution of <i>R. discolor</i> at the H.J. Andrews and Deer Creek drainage area.....	55
16: Distribution of <i>C. maculosa</i> at the H.J. Andrews and Deer Creek drainage area.....	57
17: Landscape pattern of relative abundance of <i>C. scoparius</i> at the H.J. Andrews and Deer Creek Basin area.....	61
18: Landscape pattern of relative abundance of <i>D. purpurea</i> at the H.J. Andrews and Deer Creek Basin areas.....	62
19: Landscape pattern of relative abundance of <i>R. discolor</i> at the H.J. Andrews and Deer Creek basin areas.....	64
20: Landscape pattern of relative abundance of <i>B. sylvaticum</i> at the H.J. Andrews and Deer Creek basin area.....	65
21: Standardized semivariogram for <i>H. perforatum</i> at the H.J. Andrews and Deer Creek Basin area in 2005.....	66
22: Standardized semivariogram for <i>C. leucanthemum</i> at the H.J. Andrews and Deer Creek Basin area in 2005.....	66
23: Standardized semivariogram for <i>L. muralis</i> at the H.J. Andrews and Deer Creek Basin area in 2005.....	67
24: Standardized semivariogram for <i>C. vulgare</i> at the H.J. Andrews and Deer Creek Basin area in 2005.....	67
25: Standardized semivariogram for <i>C. scoparius</i> at the H.J. Andrews and Deer Creek Basin area in 2005.....	68
26: Standardized semivariogram for <i>S. jacobaea</i> at the H.J. Andrews and Deer Creek Basin area in 2005.....	68
27: Standardized semivariogram for <i>C. arvense</i> at the H.J. Andrews and Deer Creek Basin area in 2005.....	69
28: Standardized semivariogram for <i>B. sylvaticum</i> at the H.J. Andrews and Deer Creek Basin area in 2005.....	69

LIST OF FIGURES (Continued)

<u>Figure</u>	<u>Page</u>
29: Change in distribution of <i>C. leucanthemum</i> on the H. J. Andrews Road Network from 1994 to 2005.....	74
30: Change in distribution of <i>D. purpurea</i> on the H. J. Andrews Road Network from 1994 to 2005.....	76
31: Change in distribution of <i>H. perforatum</i> on the H. J. Andrews Road Network from 1994 to 2005.....	77
32: Change in distribution of <i>C. scoparius</i> on the H. J. Andrews Road Network from 1994 to 2005.....	78
33: Change in distribution of <i>S. jacobaea</i> on the H. J. Andrews Road Network from 1994 to 2005.....	79
34: Change in Distribution of <i>R. discolor</i> on the H. J. Andrews Road Network from 1994 to 2005.....	80
35: Change in distribution of <i>C. arvensis</i> on the H. J. Andrews Road Network from 1994 to 2005.....	81
36: Change in distribution of <i>C. vulgare</i> on the H. J. Andrews Road Network from 1994 to 2005.....	82
37: Standardized semivariance comparison from 1994 to 2005 for the presence of <i>C. leucanthemum</i> on Road 1506.....	83
38: Standardized semivariance comparison from 1994 to 2005 for the presence of <i>C. leucanthemum</i> on Road 1507.....	83
39: Standardized semivariance comparison from 1994 to 2005 for the presence of <i>C. leucanthemum</i> on Road 130.....	84
40: Standardized semivariance comparison from 1994 to 2005 for the presence of <i>C. leucanthemum</i> on Road 350.....	84
41: Standardized semivariance comparison from 1994 to 2005 for the presence of <i>H. perforatum</i> on Road 1506.....	85
42: Standardized semivariance comparison from 1994 to 2005 for the presence of <i>H. perforatum</i> on Road 1507.....	85

LIST OF FIGURES (Continued)

<u>Figure</u>	<u>Page</u>
43: Standardized semivariance comparison from 1994 to 2005 for the presence of <i>H. perforatum</i> on Road 350.....	86
44: Standardized semivariance comparison from 1994 to 2005 for the presence of <i>C. scoparius</i> on Road 1506.....	86
45: Standardized semivariance comparison from 1994 to 2005 for the presence of <i>C. scoparius</i> on road 1507.....	87
46: Standardized semivariance comparison from 1994 to 2005 for the presence of <i>C. scoparius</i> on road 360.....	87
47: Standardized semivariance comparison from 1994 to 2005 for the presence of <i>C. scoparius</i> on road 1508.....	88
48: Standardized semivariance comparison from 1994 to 2005 for the presence of <i>C. scoparius</i> on road 130.....	88
49: Standardized semivariance comparison from 1994 to 2005 for the presence of <i>C. scoparius</i> on road 320.....	89
50: Standardized semivariance comparison from 1994 to 2005 for the presence of <i>C. scoparius</i> on Road 350.....	89
51: Standardized semivariance comparison from 1994 to 2005 for the presence of <i>S. jacobaea</i> on road 1506.....	90
52: Standardized semivariance comparison from 1994 to 2005 for the presence of <i>S. jacobaea</i> on road 1507.....	90
53: Standardized semivariance comparison from 1994 to 2005 for the presence of <i>S. jacobaea</i> on road 360.....	91
54: Standardized semivariance comparison from 1994 to 2005 for the presence of <i>S. jacobaea</i> on road 1508.....	91
55: Standardized semivariance comparison from 1994 to 2005 for the presence of <i>S. jacobaea</i> on road 130.....	92
56: Standardized semivariance comparison from 1994 to 2005 for the presence of <i>S. jacobaea</i> on road 320.....	92

LIST OF FIGURES (Continued)

<u>Figure</u>	<u>Page</u>
57: Standardized semivariance comparison from 1994 to 2005 for the presence of <i>S. jacobaea</i> on road 350.....	93
58: Standardized semivariance comparison from 1994 to 2005 for the presence of <i>C. arvense</i> on road 1506.....	93
59: Standardized semivariance comparison from 1994 to 2005 for the presence of <i>C. arvense</i> on road 1507.....	94
60: Standardized semivariance comparison from 1994 to 2005 for the presence of <i>C. arvense</i> on road 360.....	94
61: Standardized semivariance comparison from 1994 to 2005 for the presence of <i>C. arvense</i> on road 1508.....	95
62: Standardized semivariance comparison from 1994 to 2005 for the presence of <i>C. arvense</i> on road 130.....	95
63: Standardized semivariance comparison from 1994 to 2005 for the presence of <i>C. arvense</i> on road 320.....	96
64: Standardized semivariance comparison from 1994 to 2005 for the presence of <i>C. arvense</i> on Road 1507.....	96
65: Standardized semivariance comparison from 1994 to 2005 for the presence of <i>C. vulgare</i> on road 1506.....	97
66: Standardized semivariance comparison from 1994 to 2005 for the presence of <i>C. vulgare</i> on road 1507.....	97
67: Standardized semivariance comparison from 1994 to 2005 for the presence of <i>C. vulgare</i> on road 360.....	98
68: Standardized semivariance comparison from 1994 to 2005 for the presence of <i>C. vulgare</i> on road 1508.....	98
69: Standardized semivariance comparison from 1994 to 2005 for the presence of <i>C. vulgare</i> on road 130.....	99
70: Standardized semivariance comparison from 1994 to 2005 for the presence of <i>C. vulgare</i> on road 320.....	99

LIST OF FIGURES (Continued)

<u>Figure</u>	<u>Page</u>
71. Standardized semivariance comparison from 1994 to 2005 for the presence of <i>C. vulgare</i> on road 350.....	100
72: Landscape pattern of elevation at the H.J. Andrews Forest.....	110
73: Percentage of road network within each elevation class.....	110
74: Landscape pattern of mean annual precipitation at the H. J. Andrews Forest.....	111
75: Percentage of road network within each precipitation class.....	112
76: Landscape pattern of aspect at the H.J. Andrews Forest.....	113
77: Percentage of road network within each aspect class.....	113
78. Distribution of canopy cover estimates on the H.J. Andrews Road Network.....	114
79: Percentage of road network within each canopy cover estimate class.....	115
80: Landscape pattern of clear cutting adjacent to the road network at the H.J. Andrews.....	116
81: Percentage of road network adjacent to clear cut units, categorized by decade.....	116
82: Landscape pattern of road construction age (by decade) at the H.J. Andrews Forest.....	117
83: Percentage of road network within each road construction age (decade) class.....	118
84: Landscape pattern of road use levels at the H.J. Andrews Forest.....	119
85: Percentage of road network within each road use level class.....	119
86: Location of stream gauge stations and 250-m buffers on the H.J. Andrews road network.....	120
87: Location of thermal gauge stations and 250-m buffers on the H.J. Andrews road network.....	121

LIST OF FIGURES (Continued)

<u>Figure</u>	<u>Page</u>
88: Location of rain gauge stations and 250-m buffers on the H.J. Andrews Road Network.....	122
89: CART tree for the distribution of <i>H. perforatum</i> in 2005.....	124
90: CART tree for the distribution of <i>C. leucanthemum</i> in 2005.....	126
91: CART tree for the distribution of <i>L. muralis</i> in 2005.....	128
92: CART tree for the distribution of <i>C. vulgare</i> in 2005.....	130
93: CART tree for the distribution of <i>C. scoparius</i> in 2005.....	132
94: CART tree for the distribution of <i>S. jacobaea</i> in 2005.....	134
95: CART tree for the distribution of <i>C. arvensis</i> in 2005.....	136
96: CART tree for the distribution of <i>B. sylvaticum</i> in 2005.....	138
97: CART tree for the distribution of <i>D. purpurea</i> in 2005.....	140
98: CART tree for the distribution of <i>R. discolor</i> in 2005.....	142
99: CART tree for the distribution of <i>C. maculosa</i> in 2005.....	143
100: CART tree for the 11 year increase of <i>H. perforatum</i>	145
101: CART tree for the 11 year increase of <i>C. leucanthemum</i>	147
102: CART tree for the 11 year increase of <i>C. vulgare</i>	149
103: CART tree for the 11 year increase of <i>C. scoparius</i>	151
104: CART tree for the 11 year increase of <i>S. jacobaea</i>	152
105: CART tree for the 11 Year increase of <i>C. arvensis</i>	154
106: CART tree for the 11 year increase of <i>D. purpurea</i>	156
107: CART tree for the 11 year increase of <i>R. discolor</i>	157

LIST OF FIGURES (Continued)

<u>Figure</u>	<u>Page</u>
108: CART tree for the 11 year decrease of <i>H. perforatum</i>	159
109: CART tree for the 11 year decrease of <i>C. leucanthemum</i>	160
110: CART tree for the 11 year decrease of <i>C. vulgare</i>	162
111: CART tree for the 11 year decrease of <i>C. scoparius</i>	164
112: CART tree for the 11 year decrease of <i>S. jacobaea</i>	165
113: CART tree for the 11 year decrease of <i>C. arvense</i>	167
114: CART tree for the 11 year decrease of <i>R. discolor</i>	170
115: Total number of exotic species per 0.16-km segment at the H.J. Andrews Forest in 1994.....	183
116: Total number of exotic species (out of eight sampled in 1994) per 0.16-km segment at the H.J. Andrews Forest in 2005.....	184
117: CART tree for exotic species diversity on the road network of the H.J. Andrews Forest in 2005.....	186
118: CART tree for change in exotic species diversity on the road network of the H.J. Andrews Forest from 1994 to 2005.....	188
119: Conceptual model of plant invasion on a landscape over time.....	192
120. Conceptual diagram of exotic plant invasion over time, demonstrating correlations between explanatory landscape factors.....	218
121. Locations of logging activity, field trip sites, public use locations, and researcher and public traffic patterns in the past decade on the H.J. Andrews Forest road network (Fred Swanson, Julia Jones, and Craig Creel, personal communication).....	224

LIST OF TABLES

<u>Table</u>	<u>Page</u>
1: Summary of life history characteristics for the 11 target species sampled.....	22
2: Summary of all landscape attributes, categories, and data sources used for the GIS analysis.....	26
3: Total presence (km) and percent of network coverage for target species sampled in 2005 on the entire road network and exclusively on the H.J Andrews Forest road network.....	33
4: Total length (km) and percent network cover (based on presence/absence at 0.16-km intervals) of colonized road segments by relative abundance class for the H.J. Andrews and Deer Creek basins, and the H.J. Andrews alone.....	59
5: Variability in presence/absence of target species sampled in 2005 according to semivariogram analysis.....	70
6: Length and percent of road network in the H.J. Andrews Forest along which target exotic species were present in 1994 and 2005.....	73
7: Standardized semivariogram key used in pattern change analysis.....	101
8: Summary of spatial pattern changes by species and road from 1994 to 2005.....	103
9: Summary of landscape factors associated with presence of exotic plants in 2005.....	170
10: Summary of landscape factors associated with increase of exotic plants from 1994 to 2005.....	173
11: Summary of landscape factors associated with decrease of exotic plants from 1994 to 2005.....	175
12: Proportions of the road network in which two variables fall into the same combination of categories.....	178
13: Results of cross-tabulation test for independence of landscape variables.....	180
14: Historical distribution information for the 11 target species sampled in 2005 (from INVADERS database).....	190

Exotic Plant Species Dynamics from 1994 to 2005 on Road Networks in Forested Landscapes of Western Oregon

INTRODUCTION

Exotic plant species invasion is a global phenomenon that is associated with serious ecological, economic, and social consequences (Dukes and Mooney 1999, Mack *et. al* 2000, D'Antonio and Vitousek 1992). Many plants are *introduced*, or transported by humans across major biogeographical barriers, and some will become *naturalized* in their new habitats, overcoming both abiotic and biotic barriers to survival. A few are *invasive*, capable of reproducing many offspring in distant areas, and possibly causing ecological or economic harm (Richardson *et. al.* 2000). Aggressive invasive plants can have negative impacts on local plant communities by out-competing natives for biotic resources such as water (D'Antonio and Mahall 1991, Melgoza *et. al.* 1990), and light (Braithwaite *et. al.* 1989, Busch and Smith 1995), and by altering native plant community structure (Vivrette and Muller 1977, Martin 1999, Dunbar and Facelli 1999). Exotic species can also alter the structure and function of the physical environment. Invasive plants have been shown to alter nitrogen levels (Vitousek and Walker 1989, Witkowski 1991), nutrient cycling rates (Mack and D'Antonio 2003, Evans *et. al.* 2001, Windham and Ehrenfeld 2003), fire frequency (Whisenant 1990, Tunison *et. al.* 2001), fire intensity (Rossiter *et. al.* 2003, Platt and Gottshalk 2001), and hydrologic regimes (Dyer and Rice 1999, Rickard and Vaughen 1988).

Invasion by exotic species is second only to direct habitat destruction in the reduction of biodiversity in native areas (Myers and Bazely 2003). Large scale

eradication using manual removal or pesticides is often proposed to counter invasion, but more effective approaches to control can be developed through a better understanding of the dynamics between the exotic species and the colonized environment. Ecological and biogeographical studies of invasion patterns can also provide a scientific basis for prioritizing species for control efforts (D'Antonio *et. al.* 2004). Evaluation of physical and climatic factors associated with exotic plant distributions may help to predict whether a particular plant taxon can invade specific habitats (Rejmanek 2000). Finally, plant invasions can be viewed as unintended, real time experiments which can yield insights into plant community ecology, genetic change, spatial spread, and evolutionary processes over different spatial and temporal scales (Sax *et. al* 2005).

Two major categories of factors may influence invasion dynamics: aspects of the physical landscape that may limit where an exotic species may proliferate, and biological traits of the exotic plant species which may facilitate or inhibit its success. Landscape characteristics include physical features such as elevation and aspect, and climatic factors such as precipitation and light availability. Biological characteristics include life history attributes such as moisture requirements, seed dispersal distance, and seed germination requirements. The invasion process in a landscape can be conceptualized as a set of biological, physical, and environmental barriers which exotic plants must overcome in order to reproduce and spread (Parendes 1997, Parendes and Jones 2000, Watterson 2004).

Human-induced disturbance, such as timber harvest, road-building, and subsequent vehicle traffic on roads modify and interact with biological, physical, and

environmental barriers to facilitate invasion by altering resource levels at the community level. Roads provide corridors for plant dispersal and establishment, thus aiding exotic plants in overcoming barriers to expansion (Wilcox 1989, Willard 1990, Tyser and Worley 1992, Wilson *et. al.* 1992, Ullman *et. al.* 1995, Milton and Dean 1998, Parendes and Jones 2000, Gelbard and Belnap 2003, Watkins *et. al.* 2003, Pauchard and Alaback 2004, Rentch *et. al.* 2005). Roads can act as the initial point of entry into a landscape for exotic plants, and they are also permanent openings with continued disturbance which serve as suitable habitats for exotic species, in addition to their role in facilitating range expansion.

Invasion dynamics are difficult to quantify on an annual time scale, as plant growth is highly dependant on seasonal fluctuations of temperature and moisture (Grime 1988). However, studying patterns of distribution over many years gives a broader perspective of change at the landscape scale. Observation of the expanding, contracting, and possibly static spatial patterns of exotic species distributions over an extended time period can provide insight into biogeographical factors influencing invasion.

Objectives/Hypotheses

Although the Pacific Northwest has the least proportion of non-native plant species relative to other regions of North America (Parks *et. al.* 2005), exotic species continue to spread into mountainous areas, including the Cascade Range. The objective of this study is to (1) compare the results of a survey of exotic plant species frequency on roads conducted in 2005 to a survey conducted in 1994; (2) to describe

the current distribution and 11-year change in the spatial pattern of eight exotic plant species at the landscape scale; and (3) to highlight the role of road networks and timber harvest activity in facilitating exotic plant spread over time at the H.J. Andrews Experimental Forest, located in the Cascade Range, Oregon. The H.J. Andrews is an ideal place to study exotic plant ecology, because it contains a range of environmental and physical barriers to invasion, as well as long-term records of human activity on the landscape, such as dates and locations of road construction, timber activity, and traffic patterns. Relationships between landscape factors, presence/absence, and significant increase or decrease in exotic plant presence on the road network were explored. Four environmental and four human-influenced attributes of the landscape were included in the analysis: elevation, mean annual precipitation, aspect, canopy cover, age of adjacent clearcut unit, road age, road use level, and researcher activity.

This study addresses two hypotheses about how exotic plants are distributed in relation to other attributes of the landscape:

H₁: Exotic species distributions are correlated with the locations of clearcuts, where they could have been introduced by logging traffic, and where they would have been maintained over time by high light availability from open canopy conditions. Areas of the road network adjacent to clearcut locations should have a higher proportion of exotic species than those adjacent to undisturbed, old-growth forest patches.

H₂: Exotic species distributions have changed over time through the process of dispersal along road corridors associated with traffic and other factors promoting spread: wind, water movement, as well as change in light associated with canopy

closure. Dispersal in the 1950s and 1960s was a function of logging traffic from the mouth of the watershed to the clearcut areas, or through intentional seeding of the roadsides with exotic plant species for bank stabilization. Since 1970, dispersal has been dominated by researcher and visitor traffic from the headquarters area out to research sites and back again. Distribution change over time is also a function of light availability associated with canopy closure along roads, especially since 1970.

Landscape History

The H. J. Andrews was virtually undisturbed until 1948, when road construction, salvage, and clear-cut logging began. Most logging and road building occurred in the 1950s and 1960s, with minor additional harvest and road construction after 1970 (Franklin and Dyrness 1971). Roads were initially constructed in two phases. In 1949 and 1950, 47 km (29 miles) of road was laid on south side of Lookout Creek, in a “random” pattern, planned from year to year to meet annual timber harvest goals. These roads, including road 1507, have very steep grades, winding configurations, and high road density per unit area. In 1951, a “systematic” road plan was established for 68 km (42 miles) of roads laid on the north side of Lookout Creek to minimize steep grades, reduce the length of “climbing roads” required to harvest, and to increase the proportion of the drainage served by road levels at different elevations. This resulted in north side roads, including road 1508, that are of gentler slopes, straighter courses, and 0.62 miles less road density per section compared to the random pattern established previously (Silen 1955). The majority of road building activity (93% of the network) took place in the 1950s and 1960s, beginning at low

elevations at the mouth of the basin and continuing outward and upslope until the entire network was completed in the 1980s.

The road network currently consists of 104 km of forest roads, which are all gravel except for 3 km of paved road running along lower Lookout Creek leading to the H.J. Andrews Forest Headquarters. Road density in Lookout Creek basin is 1.9 km/km², and approximately 3% of the basin area is occupied by roads. Between 1950 and 1990, 22% of Lookout Creek was harvested in a pattern of dispersed 10-ha to 20-ha clearcuts accessed by roads (Wemple *et. al.* 1996, Jones and Grant 1996).

Various landscape and disturbance properties are correlated in space at the H.J. Andrews Forest. Corresponding to the road building pattern established in the 1950s and 1960s, other landscape attributes, particularly elevation and mean annual precipitation, are distributed in a gradient from the lower center of the basin outward and upslope to the high elevation ridges. The earliest constructed roads correspond with low elevation and less precipitation, while roads constructed in later decades at the peripheries of the network extend into higher elevations traveling up ridges exposed to more precipitation. Older roads also comprise the main arteries of the road network, and are thus subjected to more vehicle traffic by researchers and the public traveling through the experimental forest to roads over Lookout Ridge. Canopy cover follows a similar distributional gradient, as lower elevation roads at the valley floor of the basin tend to be more shaded, while higher elevation roads traverse exposed ridges with increased amounts of sunlight.

Previous Exotic Species Studies at the H.J. Andrews

This research is based upon previous work dealing with exotic plant species at the H.J. Andrews, from which a few generalized hypotheses can be summarized. These initial observations about species distributions and landscape attributes were used to justify variable selection in the current attempt to analyze exotic plant distribution change in conjunction with both natural and human-influenced aspects of the landscape. Introduction of exotic species to the H.J. Andrews Experimental Forest must have occurred sometime after 1948 and before 2005, but exact dates of introduction are not known. Few exotic plants occur anywhere except on roads and in clearcut patches. The following is a list of general observations made about invasive plants at the H.J. Andrews, and examples of prior studies that have furthered a conceptual model of plant invasion upon which this research is based.

1. A few exotic species have been present on the landscape for decades.

These long-term residents most likely entered the H. J. Andrews during extensive road building and logging in the mid-1940s and 1950s in the Lookout Creek basin. While exact dates of introduction of exotic plant species to the Andrews is not known, some grasses and legumes were intentionally introduced as part of seedling mixes to prevent cut slope erosion during road construction (Dyrness 1967, 1970, 1975). *C. scoparius* was present in clearcut units in the Blue River area as early as 1957, and was present in the rock quarry along road 1506 in the 1960s (Jerry Franklin, personal communication).

In a 1971 checklist of vascular plant species at the Andrews, Franklin and Dyrness found that approximately 10% of the 480 plant species sampled were exotic

(Parendes 1997). Included in this group are eight species of current interest: *C. scoparius* (scotch broom), *D. purpurea* (foxglove), *H. perforatum* (St. John's wort), *C. leucanthemum* (ox-eye daisy), *C. arvense* (Canada thistle), *C. vulgare* (bull thistle), *L. muralis* (wall lettuce), and *S. jacobaea* (tansy ragwort).

2. Some exotic species have been introduced into the landscape more recently.

It is likely that additional exotics were accidentally introduced into the landscape when seeds were dispersed by vehicles, included in soil imported during road construction, and carried on the clothing, shoes, and field equipment of timber harvest crews, researchers, and visitors. One way to investigate this idea is to compare seed banks on the roadside to the adjacent closed canopy forest. To test how far seeds had penetrated back into the closed canopy forest, and to assess whether seeds are present and widespread on the landscape but only able to sprout in light gaps such as roadsides and clearcuts, Parendes (1997) evaluated seed bank patterns of exotic species on and adjacent to forest roads (at 0-m, 5-m, and 50-m distances from the roadside), and found the exotic seed bank at the roadside was much larger than that within the mature forest. *C. leucanthemum* was found to be the most abundant dicot sampled, averaging 1117 seeds /m² on the roadside, but no seeds within the forested area. Similarly, *H. perforatum* and *L. muralis* were found to have over 200 seeds/m² on the roadside, and less than 10 /m² within the mature forest. Over 98% of *C. vulgare* seeds were found within 5 meters of the roadside, and very few seeds of *C. arvense* were discovered in general (3/m² at the 50-m sampling unit). Parendes (1997) demonstrated that very low densities of exotics exist in the seed bank within the mature or old-growth forest, even as close as 5 meters to the road, and that exotic

seeds are concentrated along the road network, which is a frequent host to potential vectors of spread, including vehicle tires, harvesting equipment, and shoes of hikers, researchers and visitors.

3. Along roads networks, different exotic plant species demonstrate different spatial distributions with some indication of range expansion and contraction over time.

During the summer of 1994, Parendes conducted a survey on 104.3 km of the H.J. Andrews road network, and documented the presence/absence of eight exotic plant species, *C. scoparius* (scotch broom), *H. perforatum* (St. John's wort), *C. leucanthemum* (ox-eye daisy), *C. arvense* (Canada thistle), *C. vulgare* (bull thistle), *S. jacobaea* (tansy ragwort), *R. discolor* (Himalayan blackberry), and *D. purpurea* (foxglove), within a 2 m buffer along 0.1 mi (0.16 km) sampling segments of the road network (Parendes 1997, Parendes and Jones 2000). In this study, *H. perforatum*, *C. leucanthemum* and *C. vulgare* were found to be present on > 70% of the road network; *S. jacobaea*, *C. arvense* and *C. scoparius* were present on 10% - 30% of the road network; and *D. purpurea* and *R. discolor* were isolated, found only on 1% of the road network. Using spatial statistics (semivariograms and correlograms), Parendes (1997) also found evidence of patchiness and a spatial gradient for each species analyzed along at least one of the roads sampled at the H.J. Andrews, especially for *H. perforatum*, *C. leucanthemum* and *C. vulgare*, which demonstrated strong gradients and significant patch sizes ranging from 0.2 km to 0.5 km. These species followed a large-scale gradient from long, closely spaced patches in the north central and western

portions of the basin to short, widely spaced patches in the southeast portion. *C. scoparius*, *C. arvense*, and *S. jacobaea* were less frequent, more scattered, and less patchy throughout the basin, but like their more frequent counterparts, were dominant in the north central and western portions of the H.J. Andrews. Parendes (1997) also noted some inter-annual change in spatial pattern and species frequency from 1993 to 1994. Five out of eight target species were more frequent along roads at the H.J. Andrews in 1994 than in 1993, especially *S. jacobaea* (8% more frequent in 1994) and *C. leucanthemum* (7% more frequent in 1994). However, trends were not consistent by species, and observations made over two consecutive years may be insufficient to detect significant change in frequency and pattern.

4. Both human and natural disturbances can act to create suitable habitat for exotic plants as well as transport them to new areas on a landscape.

As early as 1971, Franklin and Dryness noted a link between human disturbance and exotic plant presence at the H.J. Andrews. Included in their vascular plant checklist were exotic species found in harvest patches (*C. scoparius*, *C. leucanthemum*, *D. purpurea*, *H. perforatum*, and *C. vulgare*), along road sections (*C. scoparius*, *C. leucanthemum*, and *H. perforatum*) and in disturbed areas (*L. muralis* and *S. jacobaea*) (Franklin and Dryness 1971).

Parendes (1997) used a GIS analysis to examine exotic plant spatial pattern in relation to three human-influenced landscape attributes: age of adjacent clearcut unit, road age and road use. All target species were at least as frequent along roads adjacent to 1950's-era clear cuts as they were along roads adjacent to uncut units, and less

frequent along roads adjacent to 1960s-1970s-era cuts than uncut units. There was a weak correlation between species frequency and road use: exotics were more frequent on roads with higher traffic, but this was confounded by a correlation between high-use roads, older roads, and low elevation roads, so exotic plant frequency could not be attributed to a single variable.

To further examine the effect of road use, Parendes (1997) also documented relative abundance of twenty-one exotic plants at 50-m intervals along four habitat types: high-use roads, low-use roads, abandoned roads and streams. Species sampled included the eight sampled on the entire road network, as well as *D. glomerata* (orchard-grass), *D. carota* (Queen Anne's lace), *H. lanatus* (velvet-grass), *H. radicata* (cat's ear), *L. corniculatus* (bird's foot trefoil), *L. muralis* (wall lettuce), *P. lanceolata* (English plantain), *P. major* (common plantain), *R. acetosella* (red sorrel), *T. officinale* (common dandelion), *T. hybridum* (alsike clover), *T. pretense* (red clover), and *T. repens* (white clover).

H. perforatum, *C. leucanthemum*, *C. vulgare* and *L. muralis* dominated both high-and low-use roads, and *H. perforatum* and *L. muralis* were frequent on abandoned roads and streams. Interestingly, *L. muralis* was significantly more frequent along streams than in any other habitat type. *D. purpurea* was found only along abandoned roads in the habitat portion of the study, but was found along more frequently used roads (1506 and 360) at a greater spatial scale in the road network survey (Parendes 1997).

Samples taken at a finer spatial scale found cover values greater than 1% for: *C. leucanthemem* in high-use roads, *H. perforatum* in high and low-use roads, and *L.*

muralis in high-use roads, low-use roads, and streams. At this fine scale, percent cover of most target species was very low, and over 25% of sampling units had no target species, demonstrating that distribution patterns of exotic plants are affected by scale of observation (Parendes 1997, Parendes and Jones 2000).

In order to investigate natural disturbances that could facilitate exotic plant invasion on a landscape, in 2003, Watterson (2004) investigated the mechanisms of exotic plant invasion from roads networks into stream networks by surveying the presence of *C. scoparius* and *D. purpurea* along 48.1 km of roads and 24 km of streams at the H.J. Andrews, and comparing those distributions to maps and aerial photographs of flood and geomorphic disturbances. He found that patches of *C. scoparius* and *D. purpurea* in streams occurred down-gradient of potential hillslope seed sources where these species were mapped in 1994. Seed germination, flotation, and scarification trials were conducted, and it was found that *C. scoparius* and *D. purpurea* seeds may be capable of surviving debris flows and floods, which could be viable mechanisms for transporting exotic seeds from hillslopes into stream networks. Watterson proposed a conceptual model of stream invasion at the Andrews, in which geomorphic processes, such as the 1996 flood, overcome seed dispersal barriers by directly connecting seed sources on roads to sinks in streams at the valley bottom (Watterson and Jones 2006).

5. Physical landforms and climatic factors may facilitate or inhibit exotic distribution and potential spread

In their 1971 vascular plant checklist, Franklin and Dyrness noted some physical habitat differences in exotic plant distributions. In particular, *D. purpurea* and *L. muralis* were only found at low elevations (generally below 1,050 meters), while *S. jacobaea* and *C. vulgare* were found at both low and high (generally above 1,050 meters) elevations (Franklin and Dyrness 1971).

Parendes (1997) examined exotic plant spatial pattern in relation to four physical/climatic attributes: elevation, precipitation, aspect, and level of solar radiation. Most species demonstrated a steady decline in frequency with increasing elevation, and the frequency of most target species was lower in the higher precipitation classes. *C. leucanthemum*, *C. vulgare*, and *S. jacobaea* were negatively related to east-facing slopes, while *H. perforatum*, *C. arvense*, and *C. scoparius* had similar frequencies at all slope aspects. Data on light levels was based on output from a model estimating average daily total solar radiation during the growing season (Harmon and Marks 1995), and only 3% of the roads were within the highest or lowest radiation classes, while over 80% were within two medium-range classes, so patterns of species occurrences in these classes may not have provided much useful information about distributions. *S. jacobaea* demonstrated a negative relationship with solar radiation, and only *C. scoparius* appeared to have a slight positive relationship with solar radiation. The scale at which the solar radiation was estimated may have been too coarse to detect relationships between light levels and occurrence of target species. However, in a separate analysis of species occurrence and light

levels in varied habitat types (abandoned roads, streams, high-and low-use roads), Parendes and Jones (2000) found a strong positive relationship between light availability and exotic species occurrence. In particular, *H. perforatum* was 10 times as likely in high-light vs. low-light habitats, *C. vulgare* was 7 times as likely, and *C. leucanthemum* 3 times as likely. The odds ratios for high vs. low light were 1 to 1 for *S. jacobaea* and *C. arvense*, and *L. muralis* was the only species found to be less likely in high vs. low light habitats (Parendes and Jones 2000).

Conceptual Framework of Invasion over Time

This research is based upon a conceptual model of how both environmental and human-disturbance factors effect the introduction, establishment, and eventual spread of exotic plant species in a forested landscape (Figure 1).

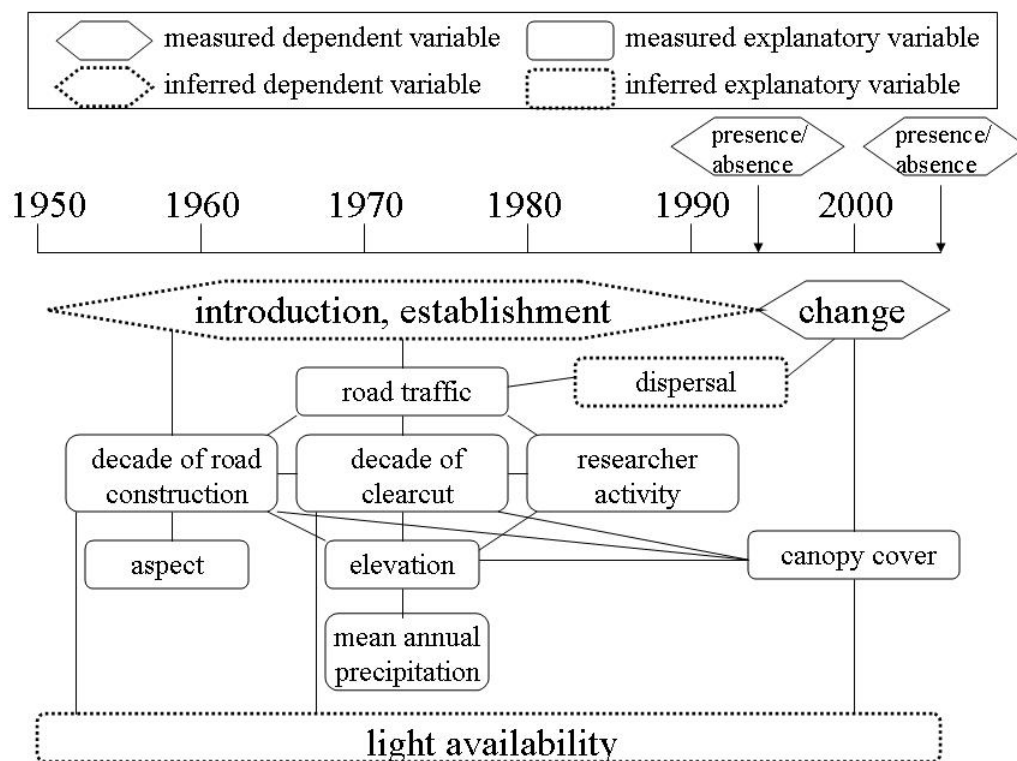

Figure 1. Conceptual model of the link between landscape factors and the presence of exotic plant species in a forested landscape.

Introductions of exotic species must have occurred some time after 1948 and before 2005 at the H.J. Andrews Forest, but exact dates of introduction are not known, thus introduction and establishment can only be inferred. At least twenty-one exotic plants were analyzed at the H.J. Andrews in 1994, and the current study repeated a presence/absence road inventory in 2005 for eight of these species, thus providing actual measurements of exotic species distributions and their subsequent change over time (Figure 1).

Dependant variables, inferred before 2005 and measured after, are a function of environmental explanatory variables distributed in space across the landscape (Figure 1). Human disturbances such as traffic and logging activity along road

networks may serve to *introduce* propagules of an exotic species into an area on the landscape. Explanatory variables that govern introduction include decade of road construction, level of road traffic, researcher activity, and decade of creation of the clearcut adjacent to the road, all of which can be linked directly to species introduction, as few exotics occur anywhere except for roads and clearcut areas. The landscape also contains physical and environmental characteristics which must be suitable for exotic species to become *established* in particular areas. Explanatory variables such as mean annual precipitation, elevation, aspect, and canopy cover are examples of environmental attributes that may be associated with exotic species distributions. These factors, both human-influenced and environmental, are also correlated with one another across the landscape.

Two explanatory influences on the plant invasion process cannot be directly measured and must be inferred: light availability and dispersal of propagules (Figure 1). Light availability effects both the establishment and the change in exotic distributions over time. The decade of road construction, decade of creation of adjacent clearcut to the road, and degree of canopy cover can be used to make inferences about the relationship between light availability and exotic species distributions. Dispersal of propagules governs the change in exotic species over time, and this explanatory variable is measured indirectly through intensity of road traffic and pattern of researcher activity on the landscape. This research attempts to uncover the relative strength of the links between plant dispersal, light availability, exotic plant distributions, human-disturbance activities, and environmental factors, all of which are correlated within the landscape.

METHODS

Study Area

The H. J. Andrews Experimental Forest is a Long-Term Ecological Research Site sponsored by the National Science Foundation and located in the Western Cascade Range, about 80 km (50 miles) east of Eugene, Oregon (Figure 2). The forest comprises the 6,400 ha (15,800 acre) drainage basin of Lookout Creek, a tributary of Blue River and McKenzie River, with elevation ranging from 410 to 1630 m (1350 to 5340 ft). The climate of the region is marine temperate. Nearly 80% of mean annual precipitation (2200 mm) falls between late November and March. Summers (June to September) receive less than 200 mm of precipitation. Monthly maximum temperature ranges between 19 °C and 28 °C in July and August to between 2 °C and 5 °C in December and January; monthly minimum temperature ranges between 8 °C and 10 °C in July and August to between -2 °C to 1 °C in December through March. The geology is composed of volcanic rocks and andesite lava flows (Swanson and James 1975). The landscape is locally steep and highly dissected, with slopes averaging above 50% (www.fsl.orst.edu/lter).



Figure 2. Location of the H.J. Andrews Experimental Forest, Blue River, Oregon. Image taken from www.fsl.orst.edu/lter.

Native vegetation is principally composed of conifer forest in the lower elevation *Tsuga heterophylla* (western hemlock) zone, and at higher elevations by *Abies amabilis* (Pacific silver fir) (Franklin and Dyrness 1988). Old-growth forest (trees approximately 200-500 years old) comprise approximately 75% of the H.J. Andrews Forest, while clear-cut areas and young plantation forests account for the remaining 25% of forest composition. Douglas-fir (*Pseudotsuga menziesii*), western hemlock (*Tsuga heterophylla*), noble fir (*Abies procera*), Pacific silver fir (*Abies amabilis*) and western red-cedar (*Thuja plicata*) dominate the study site forests. Understory vegetation includes vine maple (*Acer circinatum*) and Oregon grape (*Berberis nervosa*) (Halpern and Spies 1995).

Field Sampling

Road surveys of the presence/absence of 11 target species and abundance of 4 target species were conducted in July and August of 2005 on 104 km (65 miles) of roads in the H.J. Andrews Forest, as well as an additional 50 km (31 miles) of roads in the surrounding area (Figure 3). Portions of highway 126 and road 15 (Blue River Reservoir road) south of the H.J. Andrews were included in the survey because most traffic to the area arrives and departs along these roads. An additional 11.9 km (7.4 mi) of road 1506, and roads 640, 630, 2654, 700, 720, and 705 east of the H.J. Andrews also were surveyed; these roads are rarely traveled and are on the other side of a high ridge, separating the Blue River drainage from the upper Mackenzie River (Deer Creek) drainage. This supplementary survey data was used to compare frequencies of exotics south of the Andrews and east of the Andrews to those within the Andrews boundary. The roads surveyed for this study are referred to by road number (Figure 3).

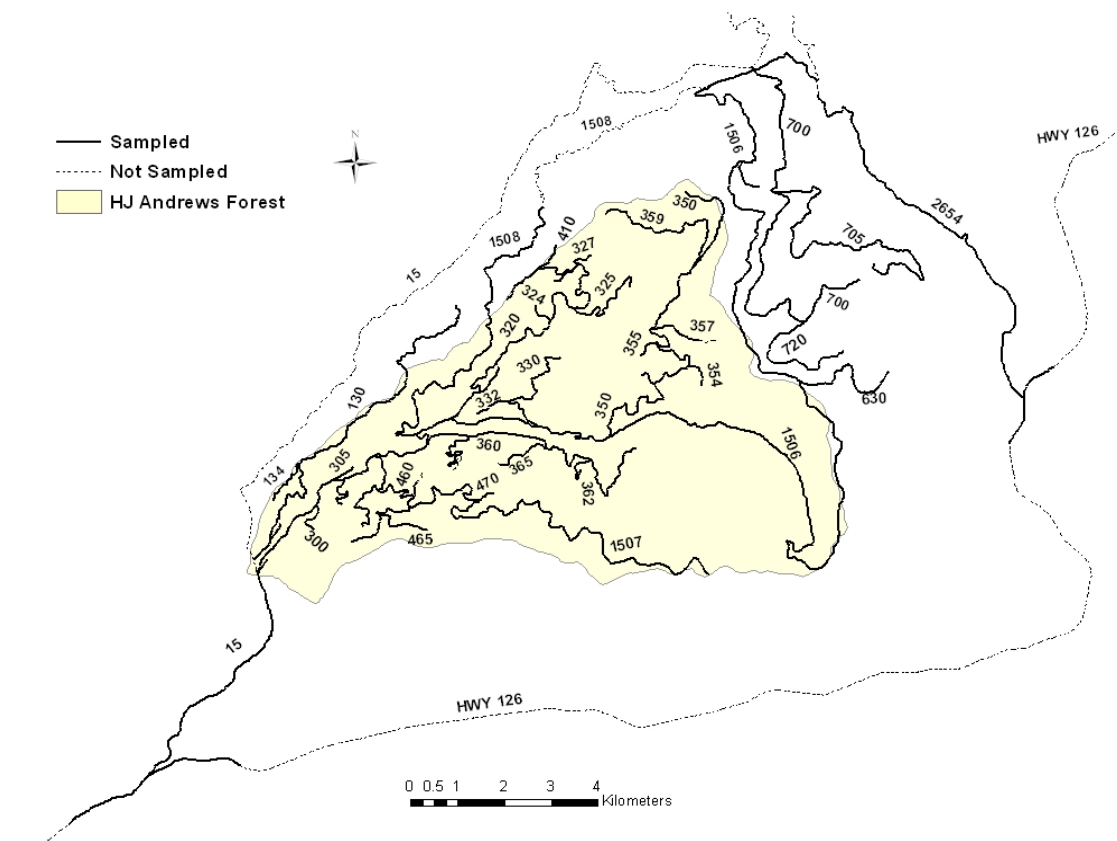

Figure 3. Roads sampled in the 2005 Survey in and around the H. J. Andrews Experimental Forest.

Presence/Absence

The presence/absence of eleven exotic plant species was noted along each 0.1 mi (0.16 km) segment of the road survey. The target species selected represent a diversity of life history traits and biological characteristics (Table 1). Eight species (*Cytisus scoparius* (Scotch broom), *Chrysanthemum leucanthemum* (ox-eye daisy), *Cirsium arvense* (Canada thistle), *Cirsium vulgare* (bull thistle), *Digitalis purpurea* (foxglove), *Hypericum perforatum* (St. John's wort), *Rubus discolor* (Himalayan blackberry), and *Senecio jacobaea* (tansy ragwort)) had been sampled at the H.J. Andrews during a 1994 road survey (Parendes 1997). Data from both the 1994 and

2005 road inventories were used to evaluate the change in exotic plant distributions over the period from 1994 to 2005. Two species, *Brachypodium sylvaticum* (false brome) and *Centaurea maculosa* (spotted knapweed), have been observed more recently at the H.J. Andrews and have proved invasive in similar Pacific Northwest forest habitats (Susan Fritts, personal communication, Parks *et. al.* 2005). *Lactuca muralis* (wall lettuce) has been documented at the H.J. Andrews before (Parendes and Jones 2000, Parendes 1997), but never on the entire road network.

The occurrence of each species was determined by driving the road network and recording presence/absence at 0.1 mi (0.16 km) increments, measured with the vehicle's odometer. Mileage was noted using a visible marker placed on the roadside at each 0.1 mi segment, and the survey was conducted by walking down the left side of the road and back up the right side. Species were recorded as present if a plant was visible within approximately 2 m from either side of the road.

Table 1. Summary of life history characteristics for the 11 target species sampled

Species	Family	Common Name	Life-Form	Mean Seed Weight (mg)	Seed Morphological Characteristics	Shade Tolerance	Propagation
<i>Digitalis purpurea</i>	Scrophulariaceae	Foxglove	biennial forb/herb	0.09	Diaspore has hard outer layer	Partial shade	Seed
<i>Hypericum perforatum</i>	Clusiaceae	St. John's wort	perennial forb/herb	0.13	Diaspore has hard outer layer	Partial shade	Seed, regeneration from roots
<i>Brachypodium sylvaticum</i>	Poaceae	False brome	perennial grass	0.2	Appendages are thin, light, flexible	Shade tolerant	Seed
<i>Chrysanthemum leucanthemum</i>	Asteraceae	Ox-eye daisy	perennial forb/herb	0.22	Diaspore has hard outer layer	Partial shade	Seed
<i>Senecio jacobaea</i>	Asteraceae	Tansy ragwort	biennial forb/herb	0.28	Appendages are thin, light, flexible	Partial shade	Seed, regeneration from roots
<i>Lactuca muralis</i>	Asteraceae	Wall lettuce	annual forb/herb	0.43	Appendages are thin, light, flexible	Shade tolerant	Seed
<i>Cirsium arvense</i>	Asteraceae	Canada thistle	perennial forb/herb	1.57	Appendages are thin, light, flexible	Shade intolerant	Seed, regeneration from roots, cuttings
<i>Centura maculosa</i>	Asteraceae	Spotted knapweed	biennial forb/herb	1.7	Diaspore has hard outer layer	Partial shade	Seed
<i>Cirsium vulgare</i>	Asteraceae	Bull thistle	biennial forb/herb	2.85	Appendages are thin, light, flexible	Shade intolerant	Seed
<i>Rubus discolor</i>	Rosaceae	Himalayan blackberry	perennial subshrub	5.34	Diaspore has juicy, fleshy outer layer	Partial shade	Seed, regeneration from roots, cuttings
<i>Cytisus scoparius</i>	Fabaceae	Scotch broom	perennial shrub	7.6	Diaspore has hard outer layer	Shade intolerant	Seed, regeneration from roots

Relative Abundance

Relative abundance was also noted for four exotic plant species: *Cytisus scoparius* (Scotch broom), *Digitalis purpurea* (foxglove), *Rubus discolor* (Himalayan blackberry), and *Brachypodium sylvaticum* (false brome). These species were chosen because they (1) represent a significant threat to the biodiversity of the Cascade mountains (Parks *et. al.* 2005), (2) have been recently introduced or detected, or (3) are being closely monitored by the Mackenzie River Forest District (Susan Fritts, personal communication). These four species also have diverse life histories and biological characteristics, including a shade tolerant bunchgrass (*B. sylvaticum*), a biennial flowering herb (*D. purpurea*), a fruiting shrub (*R. discolor*), and a nitrogen-fixing shrub (*C. scoparius*). This survey represents the beginning of a monitoring program to document the possible future spread of these particular plants, which have proved very invasive in similar habitats west of the Cascades. Relative abundance of each species was based on an estimate of the number of individuals within each 0.1 mi (0.16 km) sampling unit, within 2 m from the road edge, on both sides of the road, and was classified on an approximate logarithmic scale following Parendes (1997): rare (1-10 plants), common (11-100 plants) or abundant (greater than 100 plants).

Canopy Cover

Within each 0.1 mi (0.16 km) sampling unit, light levels were estimated based on ocular assessment of tree canopy cover on both sides of the road. Canopy cover was classified into one of six categories in the field, based on approximate percent canopy cover: very low ($\leq 10\%$ cover), low (11% - 30% cover), medium-low (31% - 45% cover), medium (45% - 65% cover), medium-high (66% - 85% cover), and high

(\geq 85% cover). Estimates were made in the afternoon, between 12 pm and 3 pm each day, at a consistent sun angle.

GIS Analysis

Spatial analysis of the distribution patterns of exotic plants was conducted of the H.J. Andrews and Deer Creek areas using ArcGIS. A spatial layer of the road network and the H.J. Andrews Forest boundary, obtained from the USFS Data Bank (www.fsl.orst.edu/lter), was used to link species distributions and roads. Roads were dynamically segmented, and presence/absence and relative abundance were plotted at 0.16 km (0.1 mi) segments along the network (See Appendix A for specific steps used in the dynamic segmentation analysis). Shapefiles were created of 1994 and 2005 presence/absence data, as well as 2005 relative abundance data, and are included in a database of the USFS Data Bank (www.fsl.orst.edu/lter).

ArcGIS was also used to link environmental attributes to the road network. Ten environmental attributes were selected and spatially related to exotic species presence/absence on the road network (Table 2). Four attributes represent physical/climatic attributes of the environment, while the six others represent potential human disturbances on the landscape. Each landscape attribute was classified into categories for analysis and included as a separate layer in the GIS. Elevation, precipitation, aspect, age of adjacent cut unit, road age and road-use layers were classified according to categories defined by Parendes in 1997, in order to make comparisons between 1994 and 2005 distributions. Three variables were added to the analysis: proximity to stations used to collect long-term records, which receive regular traffic by researchers. Proximity to stream, temperature, and rain gauging

stations were classified by delineating a 250 m buffer around each station and assigning a binary variable to each 0.16 km (0.1 mi) segment, where 1 = road segment is within a 250 m of a station (intersects the buffer), and 0 = road is not within 250 m of a station (see Appendix A for specific steps used in the GIS analysis). All GIS layers used were downloaded from the USFS data bank (www.fsl.orst.edu/lter).

Table 2. Summary of all landscape attributes, categories, and data sources used for the GIS analysis.

Attribute	Factor Type	Defined Categories	Data Source	Justification of Class Divisions
Elevation	Physical	< 600 m 600 – 900 m 900 – 1200 m 1200 – 1500 m	1:24,000 DEM accessed from (www.fsl.orst.edu/lter)	Classes set by Parendes in 1997
Precipitation	Climatic	< 2400 mm/yr 2400 – 2800 mm/yr 2800 – 3200 mm/yr > 3200 mm/yr	HJA metrological network station data spatially interpreted to raster grid, accessed from (www.fsl.orst.edu/lter)	Classes set by Parendes in 1997
Aspect	Physical	North (304°-34°) South (124°-214°) East (34°-124°) West (214°-304°)	Grid APSECT function used on a DEM to create a raster grid, accessed from (www.fsl.orst.edu/lter)	Classes defined by four main cardinal aspect directions
Canopy Cover	Physical	Very low (< 10%) Low (11% - 30%) Med-low (31% - 45%) Medium (45% - 65%) Med-High (66% 85%) High (>86%)	Field research: ocular estimate of roadside canopy cover at each 0.16 km segment on the road network	Classes defined in 2005 based on observation of canopy cover patterns
Age of Adjacent Clearcut Unit	Human Influenced	0 (not cut) 1950 – 1959 1960 -1969 1970 - 1979 1980 - 1989 1990 - 1999	GIS vector layer, “Managed Stands, Harvest Year” accessed from (www.fsl.orst.edu/lter)	Classes defined by decade according to Parendes in 1997
Road Construction Age	Human Influenced	1940 - 1949 1950 – 1959 1960 -1969 1970 - 1979 1980 - 1989	GIS vector layer, “Road Construction History” accessed from (www.fsl.orst.edu/lter)	Classes defined by decade according to Parendes in 1997
Road Use Level	Human Influenced	Low (less than 1 vehicle every 14 days) Medium (1 vehicle every 7-14 days) High (more than 1 vehicle every 1-7 days)	GIS vector layer created by Parendes (1997), based on estimated frequency of vehicle travel	Frequency of vehicle travel estimated by L. Parendes, A. McKee, and F. Swanson (Parendes 1997)
Proximity to Stream Gauging Stations	Human Influenced	1 = road segment within 250 m buffer 0 = road segment not within 250 m buffer	GIS vector layer of HJA stream gage stations accessed from (www.fsl.orst.edu/lter)	250 m buffer defined as appropriate size to incorporate at least one, at most three, adjacent 0.16 km road segments
Proximity to Thermal Gauging Stations	Human Influenced	1 = road segment within 250 m buffer 0 = road segment not within 250 m buffer	GIS vector layer of HJA thermal gage stations accessed from (www.fsl.orst.edu/lter)	250 m buffer defined as appropriate size to incorporate at least one, at most three, adjacent 0.16 km road segments
Proximity to Rain Gauging Stations	Human Influenced	1 = road segment within 250 m buffer 0 = road segment not within 250 m buffer	GIS vector layer of HJA rain gage stations accessed from (www.fsl.orst.edu/lter)	250 m buffer defined as appropriate size to incorporate at least one, at most three, adjacent 0.16 km road segments

Geostatistical Analysis

Semivariograms were constructed to quantify the spatial structure of eight exotic species sampled in 2005 (*C. leucanthemum*, *H. perforatum*, *C. vulgare*, *C. arvensis*, *C. scoparius*, *S. jacobaea*, *L. muralis*, and *B. sylvaticum*). *R. discolor*, *D. purpurea*, and *C. maculosa* were omitted from this assessment, because their distribution was so sparse that spatial analysis would not be meaningful (Errington 1973). Standardized semivariograms were used to assess patch/gap contrast, patch size, and detect evidence of a spatial gradient. The sill, or the maximum value of semivariance, and the range, or the lag distance at which the sill occurs, were used as indicators of patch size. Standardized semivariogram profile, such as a linear or spherical shape, was used to indicate a potential gradient spatial pattern on the road analyzed (Legendre and Fortin 1989).

Only roads longer than 5.8 km (3.6 miles) were used to analyze pattern, as the accuracy of the pattern quantified by semivariograms depends on the sample size of the data (Fortin *et. al.* 1989), and roads 5.8 km or greater contained at least 30 observations (0.16-km segments) for analysis. A maximum of twelve individual roads (representing approximately 75.7% of the road network) were included in the analysis (Figure 4). In some cases, species presence on individual roads was either too sparse or too continuous in order for spatial analysis to be meaningful, so each species was analyzed only on those roads in which presence ranged between 5% and 95%. For examination of spatial pattern in 2005, a total of 67 standardized semivariograms were created, and one graph was made for each species, depicting the spatial variability by roads.

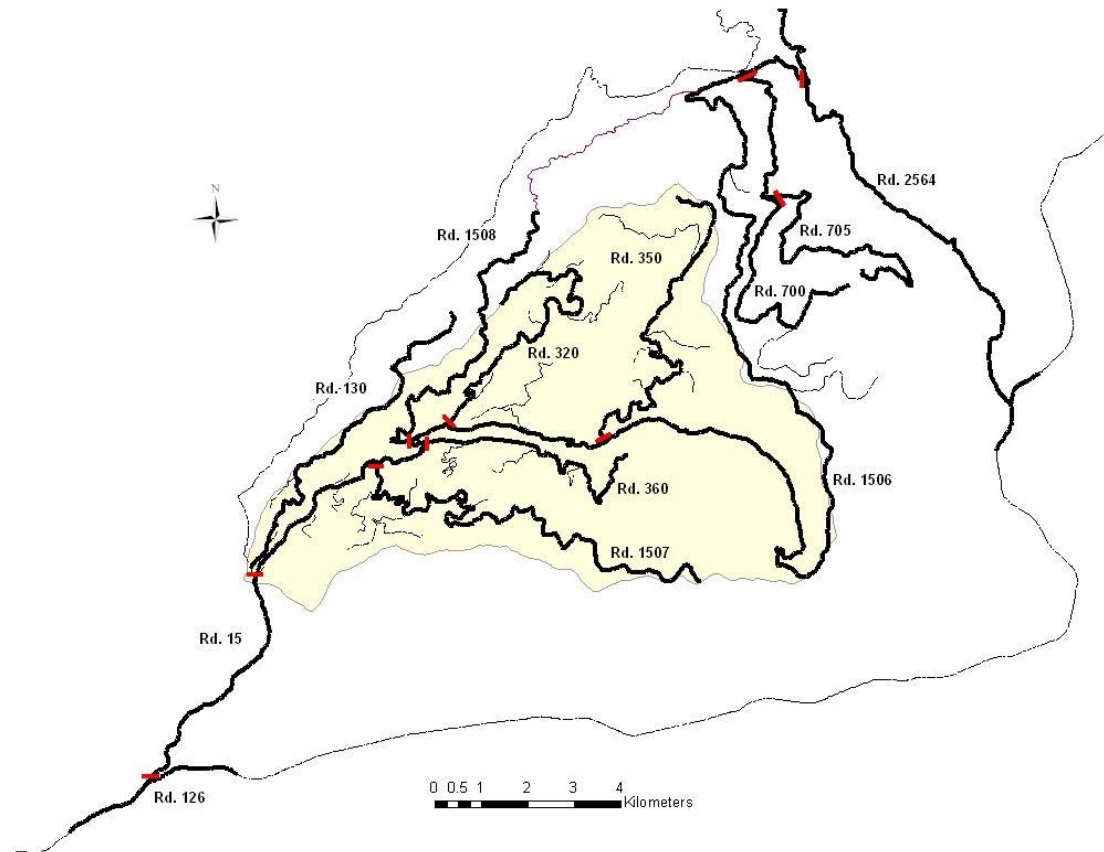

Figure 4. Roads in the H.J. Andrews and Deer Creek Basin areas that were used in the analysis of spatial pattern in 2005. Roads used are in bold, while roads sampled but not included in the spatial analysis are represented by a dotted line. Beginning portions of roads are marked with a red bar.

Semivariograms were also constructed to quantify the change in spatial structure of six exotic species sampled in 1994 and 2005 (*C. leucanthemum*, *H. performatum*, *C. vulgare*, *C. arvense*, *C. scoparius*, and *S. jacobaea*). *R. discolor* and *D. purpurea* were omitted from this assessment because their distributions were too rare. Spatial pattern was quantified and compared for 1994 and 2005 along seven roads greater than 5.8 km in length within the H.J. Andrews Forest (i.e. roads had at least thirty 0.16-km segments) (Figure 5). For examination of spatial pattern change

from 1994 to 2005, change was graphed for each road/species combination, resulting in a total of 35 graphs depicting spatial variability change over time.

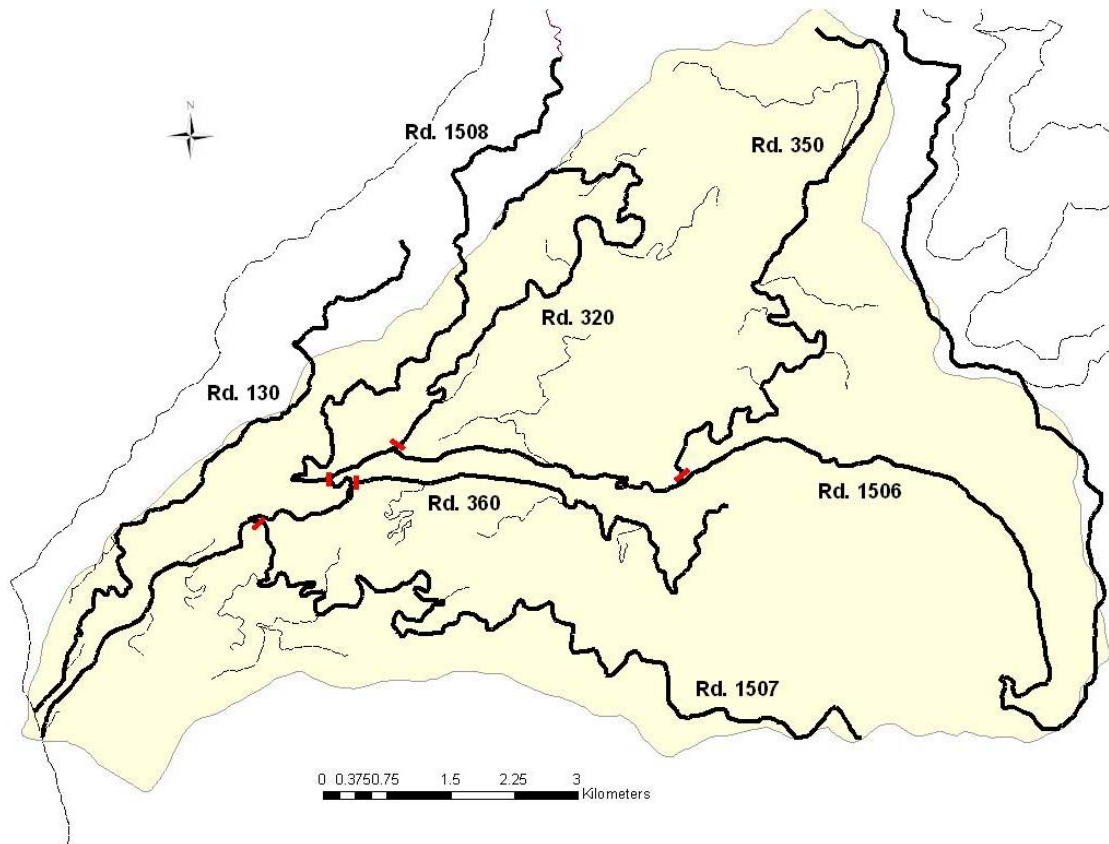

Figure 5. Roads used in the H.J. Andrews and Deer Creek Basin area that were used in the evaluation of spatial change from 1994 to 2005. Roads used are in bold, while roads sampled but not included in the spatial analysis are represented by a dotted line. Beginning portions of roads are marked with a red bar.

Statistical Analysis

The relationships between species presence in 2005, species increase from 1994 to 2005, species decrease from 1994 to 2005, exotic plant diversity, and 10 environmental and human disturbance factors were explored using a CART (Classification Analysis and Regression Tree) analysis (Brieman *et. al.* 1984). Non-

parametric CART models recursively partition variability in a dataset into subsets that are increasingly homogeneous with respect to the defined groups, resulting in a tree-like classification in which the most typical case is given, and then alternative settings that qualify as habitat are identified as different branches of the tree. CART models can readily admit a mix of categorical, rank, and continuous variables, and correlations among variables are also well handled because only the single best predictor variable is selected at each branch of the tree (Urban 2002). Twenty-eight separate CART trees were made: 11 for the 11 species sampled in 2005, 8 for the 8 species evaluated for increase from 1994 and 2005, 7 for the 7 species evaluated for decrease from 1994 to 2005, and 2 for the diversity in 2005 and the change in diversity from 1994 to 2005. *D. purpurea* was not evaluated for decrease from 1994 to 2005 as no decrease was detected in any segment on the road network.

In this application, presence, increase and decrease were represented as discrete, binary response variables for each of the 645, 0.16-km road segments sampled. Presence for 1994 and 2005 was defined as a “1” if a particular species was present in that segment in 1994 or 2005, and a “0” if that species was not found. CART trees were built for the 8 species sampled in 1994 (*C. leucanthemum*, *H. perforatum*, *S. jacobaea*, *C. scoparius*, *C. arvense*, *C. vulgare*, *R. discolor*, and *D. purpurea*) as well as for the 11 species sampled in 2005 (*C. leucanthemum*, *H. perforatum*, *S. jacobaea*, *C. scoparius*, *C. arvense*, *C. vulgare*, *R. discolor*, *D. purpurea*, *B. sylvaticum*, *C. maculosa*, and *L. muralis*).

Eleven-year increase in each 0.16-km road segment was defined as a “1” if that particular species was absent in 1994 and present in 2005 and a “0” for all other cases,

while 11-year decrease was defined as a “1” if that certain species was present in 1994 and absent in 2005 and a “0” for all other cases. The eight species sampled in both years, *C. leucanthemum*, *H. perforatum*, *S. jacobaea*, *C. scoparius*, *C. arvensis*, *C. vulgare*, *R. discolor*, and *D. purpurea* were used to build CART trees for 11-year increase and 11-year decrease.

Ten landscape variables were evaluated as explanatory variables (Table 2). Four variables represent physical/climatic factors in the landscape, and include elevation, mean annual precipitation, aspect, and canopy cover. The six others, age of adjacent clearcut unit, road age, road use level, proximity to stream gauging stations, proximity to thermal gauging stations, and proximity to rain gauging stations represent human disturbance factors which may help to explain species presence, increase, or decrease. Proximity to gauging stations was represented as a discrete, binary variable, while all other factors were analyzed as categorical variables (Table 2).

Evaluation of Exotic Species Diversity

In order to identify “hotspots” of invaded areas on the landscape, the exotic species diversity, or the total number of exotics present per road segment was calculated for 2005. Additionally, the change in diversity, or the change in total number of exotic species per road segment from 1994 to 2005 was calculated.

The total number of exotic species present on a road segment in 1994 (out of 8) was added to the total number of exotic species present on a road segment in 2005 (out of 11) to obtain a measure of exotic diversity ranging in value from 0 to 19 per 0.16-km road segment. The total number of exotic species present on a road segment in

2005 (out of 11) was subtracted from the total number of exotic species present on a road segment in 1994 (out of 8) to obtain a measure of the change in exotic diversity, ranging in value from - 8 to 11 per 0.16-km road segment. ArcGIS was used to map exotic species diversity in 2005, and the change in diversity from 1994 to 2005.

Two regression trees were created to explore the relationship between the 10 landscape variables and (1) the diversity of exotic species on the road network and (2) the change in diversity on the road network. In this analysis, response was a continuous, multinomial variable (numbers of species per road segment) instead of a binary variable (presence/absence per road segment) so a regression tree was created as opposed to a classification tree. Models were limited to 10 terminal nodes in order to avoid overfitting of the data (Urban 2001). The purpose of this analysis was to find the few most important landscape factors accounting for diversity and change in diversity in species on the network, thus division into more than 10 terminal nodes was deemed unnecessary.

RESULTS

Spatial Distribution of Exotic Species in 2005

The eleven exotic species surveyed in 2005 greatly varied in both their frequencies and spatial patterns along the road network. Target species covered as little as 3.7% (*C. maculosa* - spotted knapweed) to as much as 90.2% (*H. perforatum* – St. John’s wort) of the entire network sampled (Table 3).

Table 3. Total presence (km) and percent of network coverage for target species sampled in 2005 on the entire road network and exclusively on the H.J Andrews Forest road network.

Species	Common Name	Total Presence on Entire Network (km)	Percent of Total Network	Total Presence on H.J.A Network (km)	Percent of H.J.A. Network
<i>Hypericum perforatum</i>	St. John’s wort	152.9	90.2	102.8	98.7
<i>Chrysanthemum leucanthemum</i>	Ox-eye daisy	133.7	78.9	96.2	92.3
<i>Lactuca muralis</i>	Wall lettuce	132.0	77.9	87.1	83.6
<i>Cirsium vulgare</i>	Bull thistle	71.5	42.1	54.1	51.9
<i>Senecio jacobaea</i>	Tansy ragwort	44.3	26.1	34.4	33.0
<i>Cytisus scoparius</i>	Scotch broom	34.9	20.6	18.3	17.6
<i>Cirsium arvense</i>	Canada thistle	19.8	11.7	15.8	15.2
<i>Brachypodium sylvaticum</i>	False brome	14.0	8.3	10.4	10.0
<i>Digitalis purpurea</i>	Foxglove	13.8	8.2	8.9	8.5
<i>Rubus discolor</i>	Himalayan blackberry	13.2	7.8	1.6	1.5
<i>Centaurea maculosa</i>	Spotted knapweed	6.2	3.7	1.1	1.1
Total Road Length (km)		169.5		104.2	

Species distributions can be broken into three qualitative groupings. Very common species (i.e. *H. perforatum*, *C. leucanthemum*, and *L. muralis*) were present on > 75% of the road network (Table 3). *H. perforatum* (90.2% frequency) and *C. leucanthemum* (78.9 % frequency) were continually distributed within the H.J. Andrews but were discontinually distributed on the roads in the Deer Creek Basin, with the exception of road 2654, on which presence was continuous (Figures 6 and 7). *L. muralis* (77.9% frequency) had a slightly less continuous distribution at the H.J. Andrews, and was discontinuous on the roads in the Deer Creek Basin (Figure 6). All three of these dominant species had nearly continuous distributions on the major roads (roads 126 and 15).

Figure 6. Distribution of *H. perforatum* at the H.J. Andrews and Deer Creek drainage area.

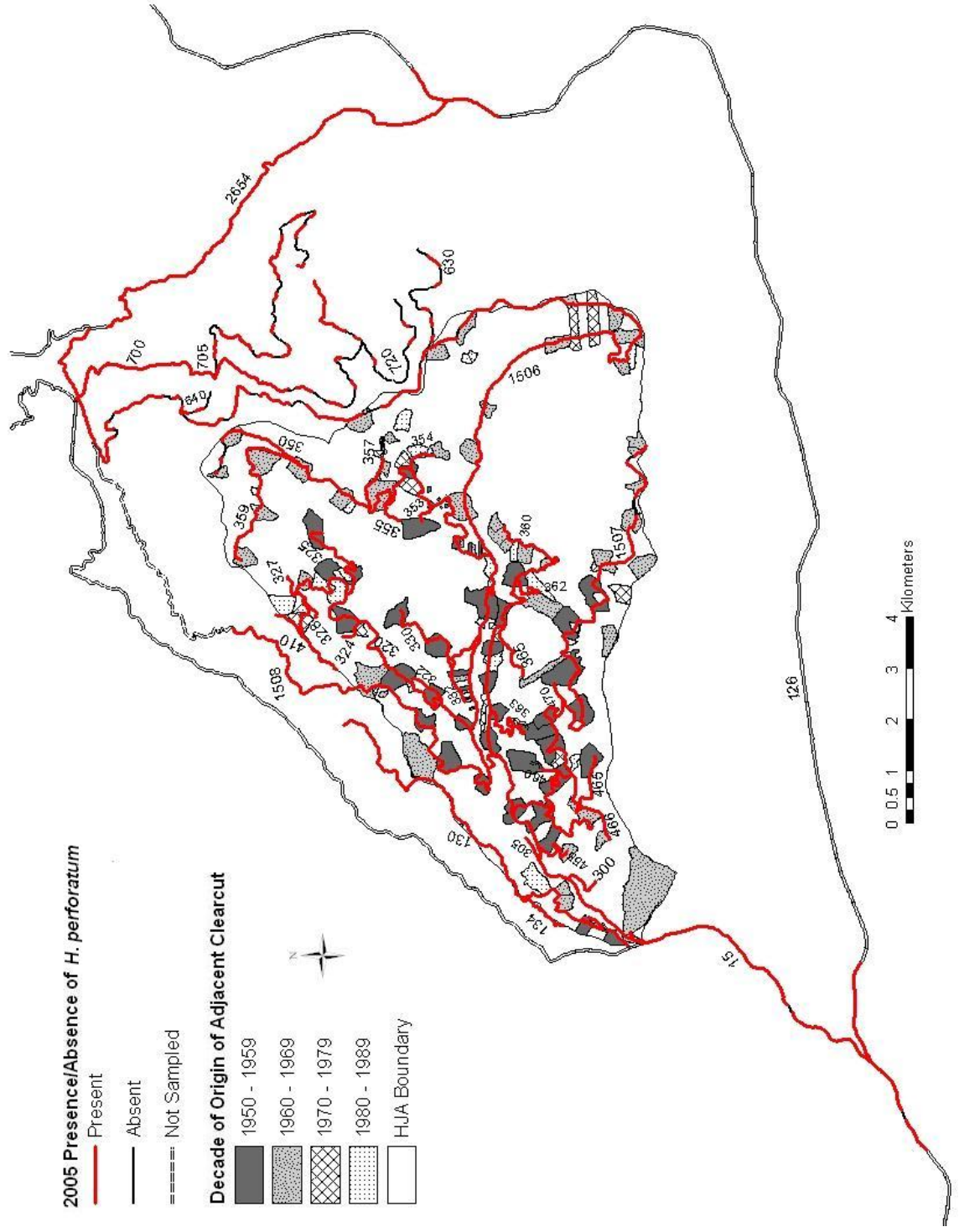

Figure 7. Distribution of *C. leucanthemum* at the H.J. Andrews and Deer Creek drainage area.

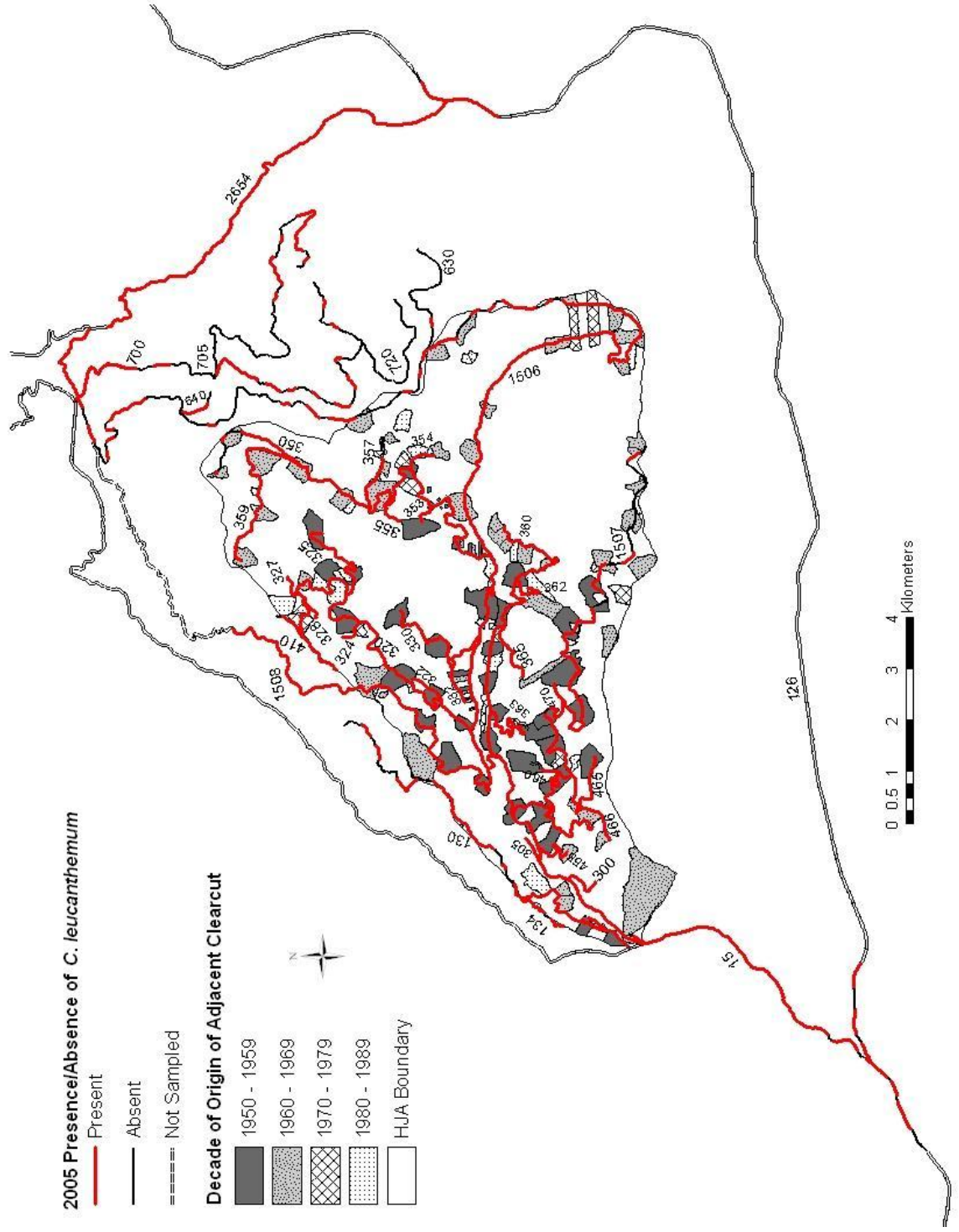
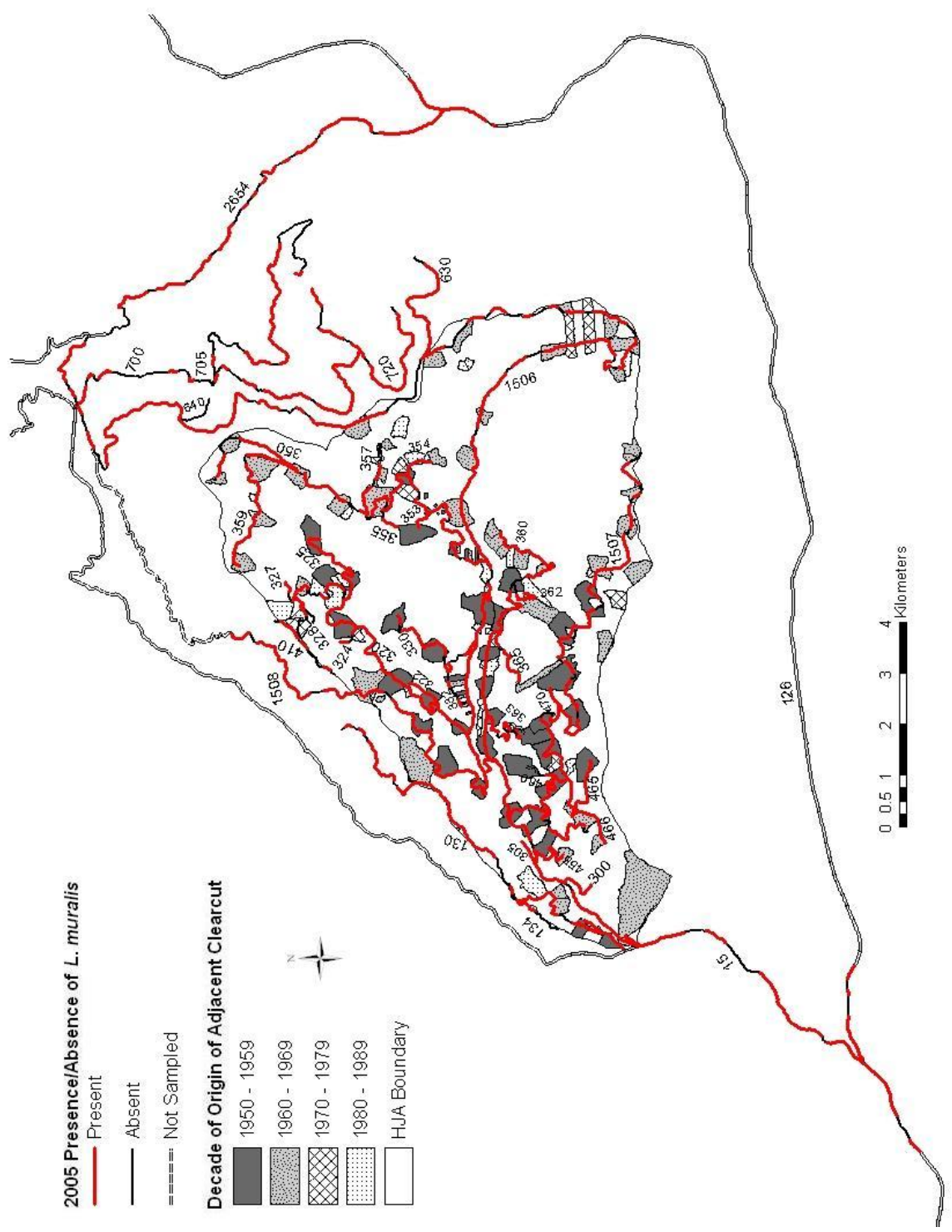

Figure 8. Distribution of *L. muralis* at the H.J. Andrews and Deer Creek drainage area.



Intermediate species (i.e. *C. vulgare*, *S. jacobaea*, *C. scoparius*, and *C. arvense*) were present on 10% to 45% of the road network (Table 3). Both *C. vulgare* and *C. scoparius*, representing 42.1% and 20.6% of the road network, are continuously distributed on some roads and discontinuously distributed on others (Figures 9 and 10). *C. scoparius* is nearly continuously distributed on roads 126 and 15, while *C. vulgare* is irregular on these major roads. *S. jacobaea* and *C. arvense* are present on 26.1% and 11.7% of the road network, and are more discontinuous in their spatial pattern, occurring in remote patches on high elevation roads far from continuous segments (Figures 11 and 12). Both *S. jacobaea* and *C. arvense* are rare on the major roads of 15 and 126. All four of these intermediate-frequency species are rare in the Deer Creek basin, but do show presence in some remote patches at higher elevations over the east ridge.

Figure 9. Distribution of *C .vulgare* at the H.J. Andrews and Deer Creek drainage area.

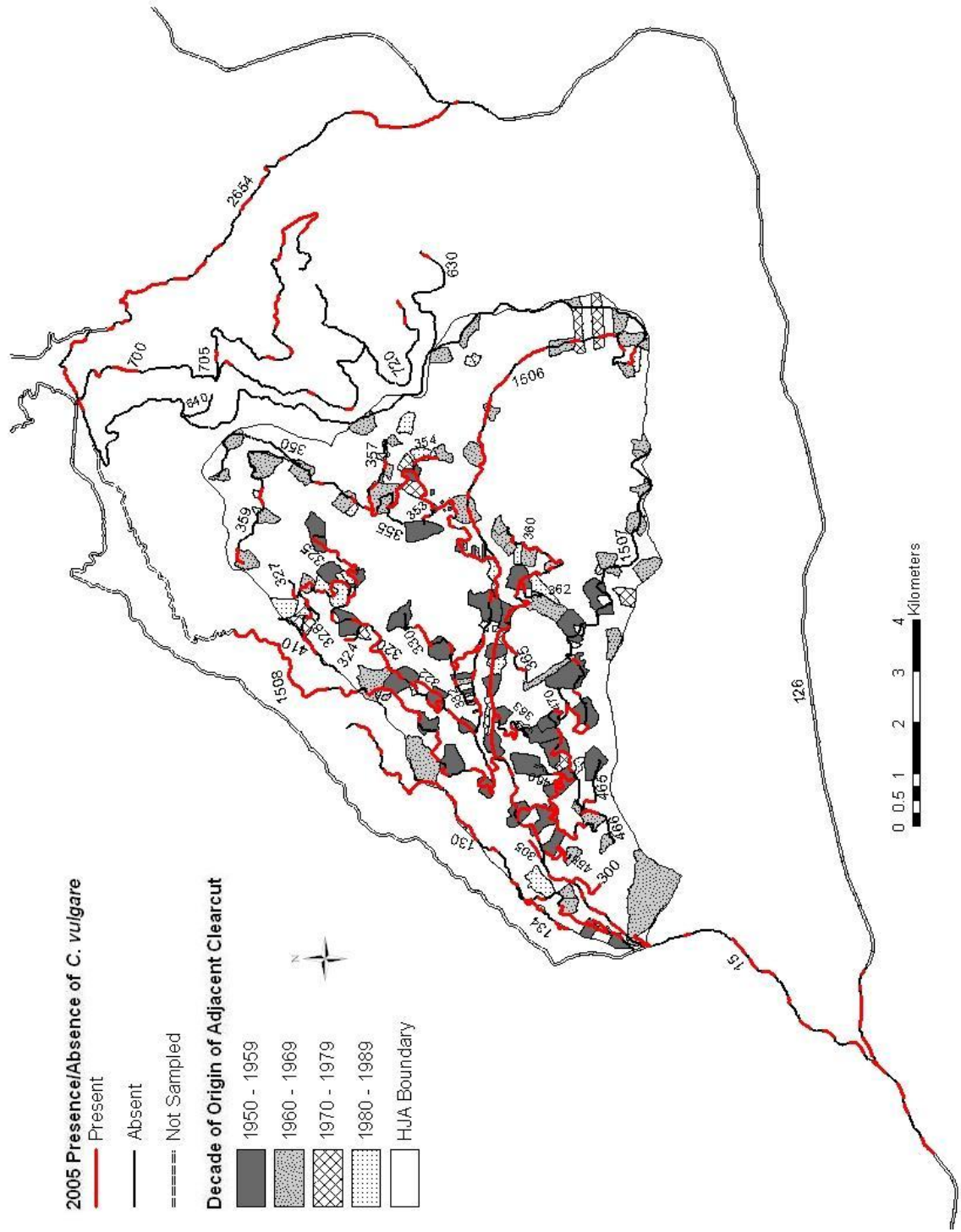

Figure 10. Distribution of *C. scoparius* at the H.J. Andrews and Deer Creek drainage area.

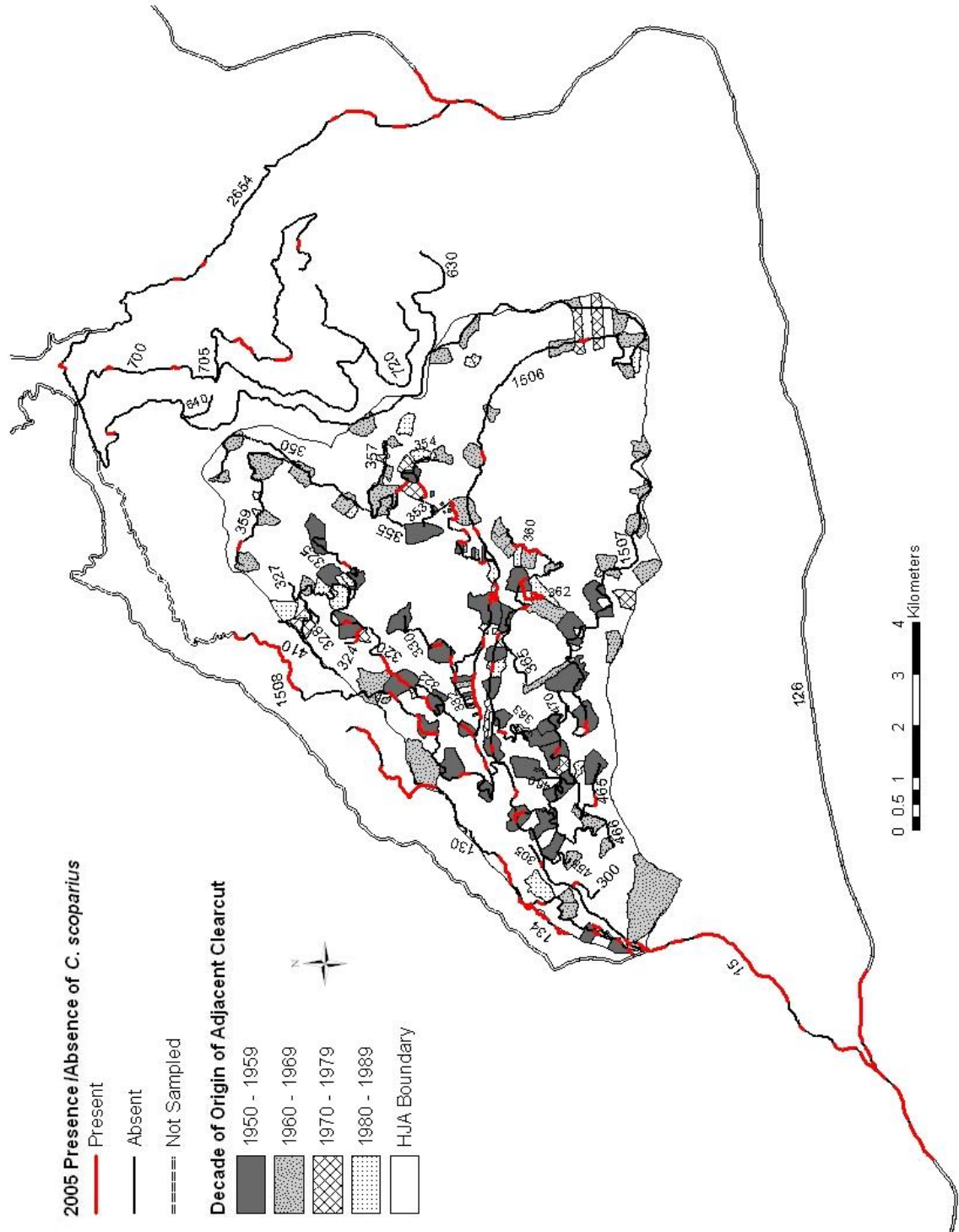

Figure 11. Distribution of *S. jacobaea* at the H.J. Andrews and Deer Creek drainage area.

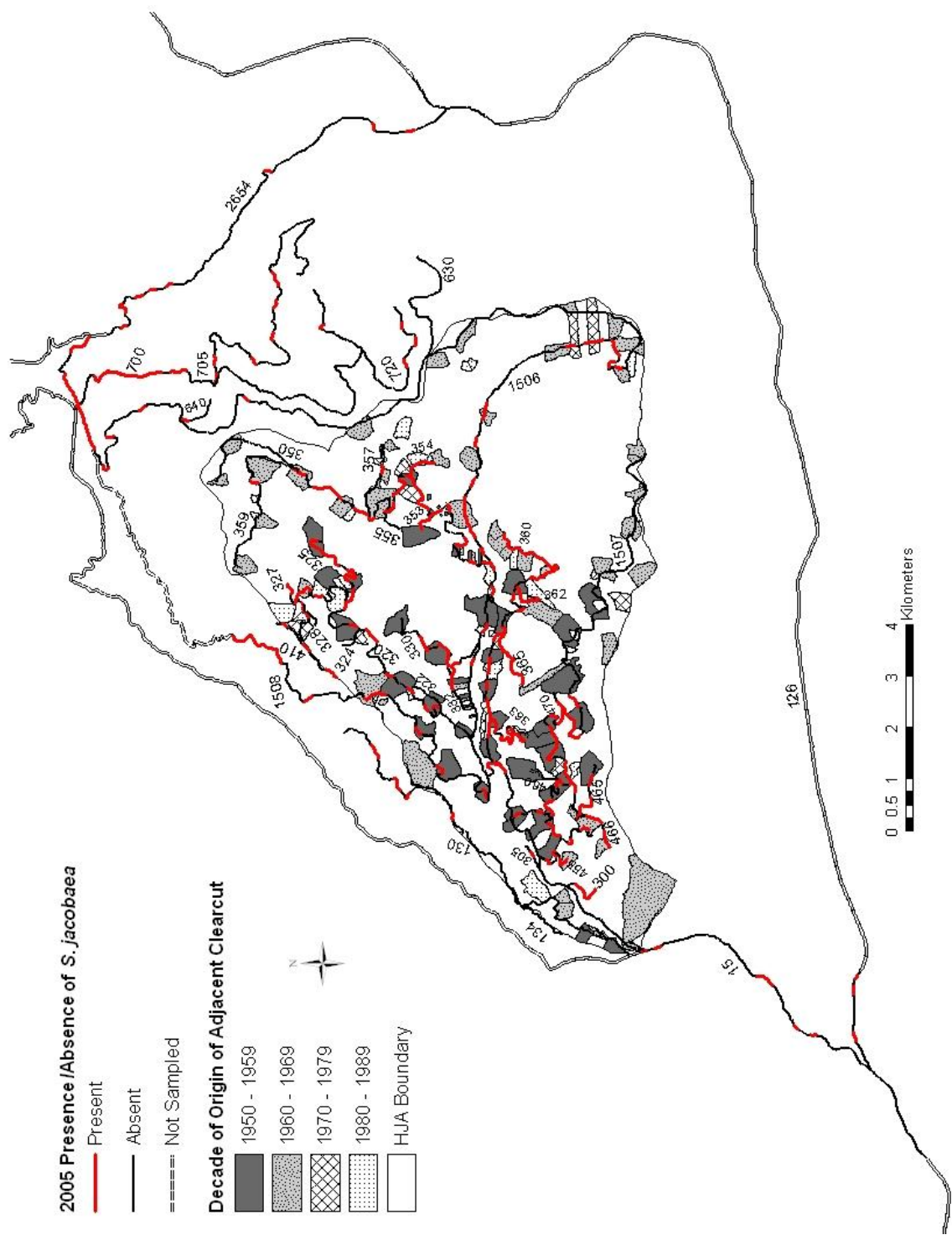
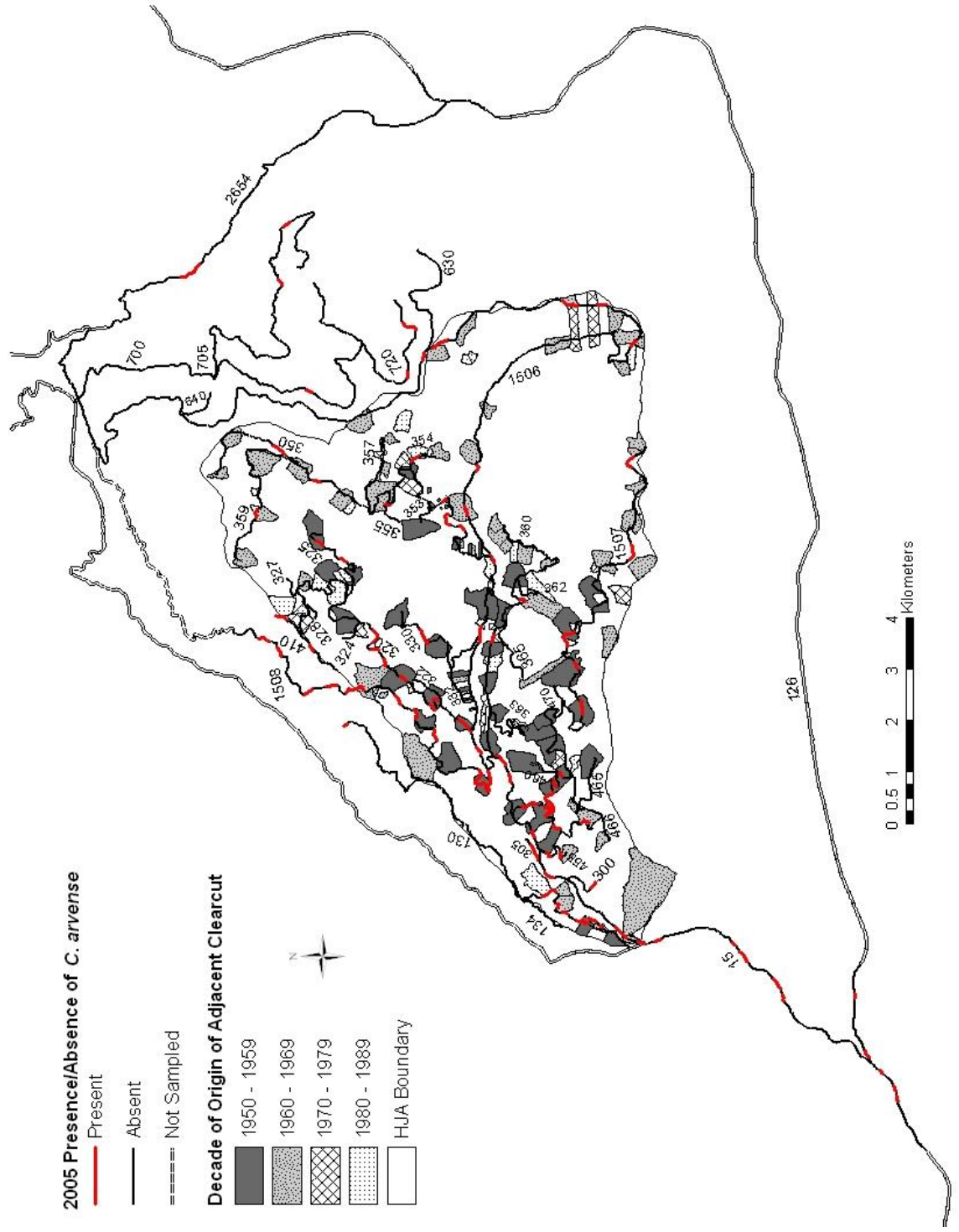

Figure 12. Distribution of *C. arvensis* at the H.J. Andrews and Deer Creek drainage area.



Less common species (i.e. *B. sylvaticum*, *D. purpurea*, *R. discolor*, and *C. maculosa*) were present on less than 10% of the roads sampled (Table 3) and can be considered relatively rare on the network. *B. sylvaticum* and *D. purpurea*, representing 8.3% and 8.2% of the road network, were continually distributed on a few roads (15, 1506, and 2654 for *B. sylvaticum*; 360 and 1506 for *D. purpurea*) and more discontinuous on the rest of the road network, as well as the major roads of 15 and 126 (Figures 13 and 14). *R. discolor* (7.8% frequency) showed a similar discontinuous distribution on the H.J. Andrews road network, but was nearly continually distributed on the major roads 126 and 15 at the southern portion of the basin (Figure 15). *C. maculosa*, present on only 3.7% of the road network, was nearly absent from the H.J. Andrews except for one continuous stretch on road 410, and also occurred outside of the H.J. Andrews boundary, on the major roads 126 and 15 (Figure 16). All four less common species were infrequent to absent on the Deer Creek Basin roads.

Figure 13. Distribution of *B. sylvaticum* at the H.J. Andrews and Deer Creek drainage area.

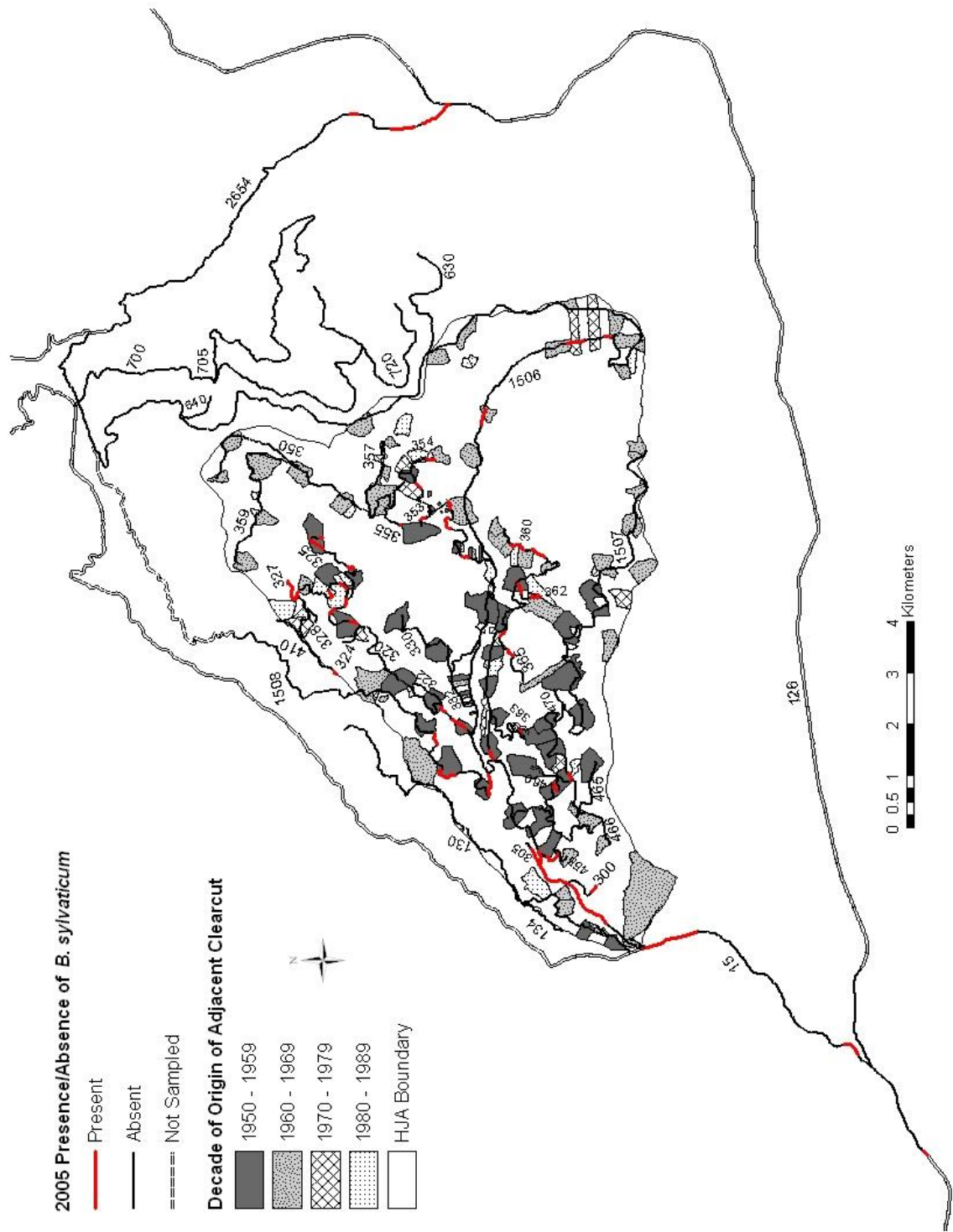

Figure 14. Distribution of *D. purpurea* at the H.J. Andrews and Deer Creek drainage area.

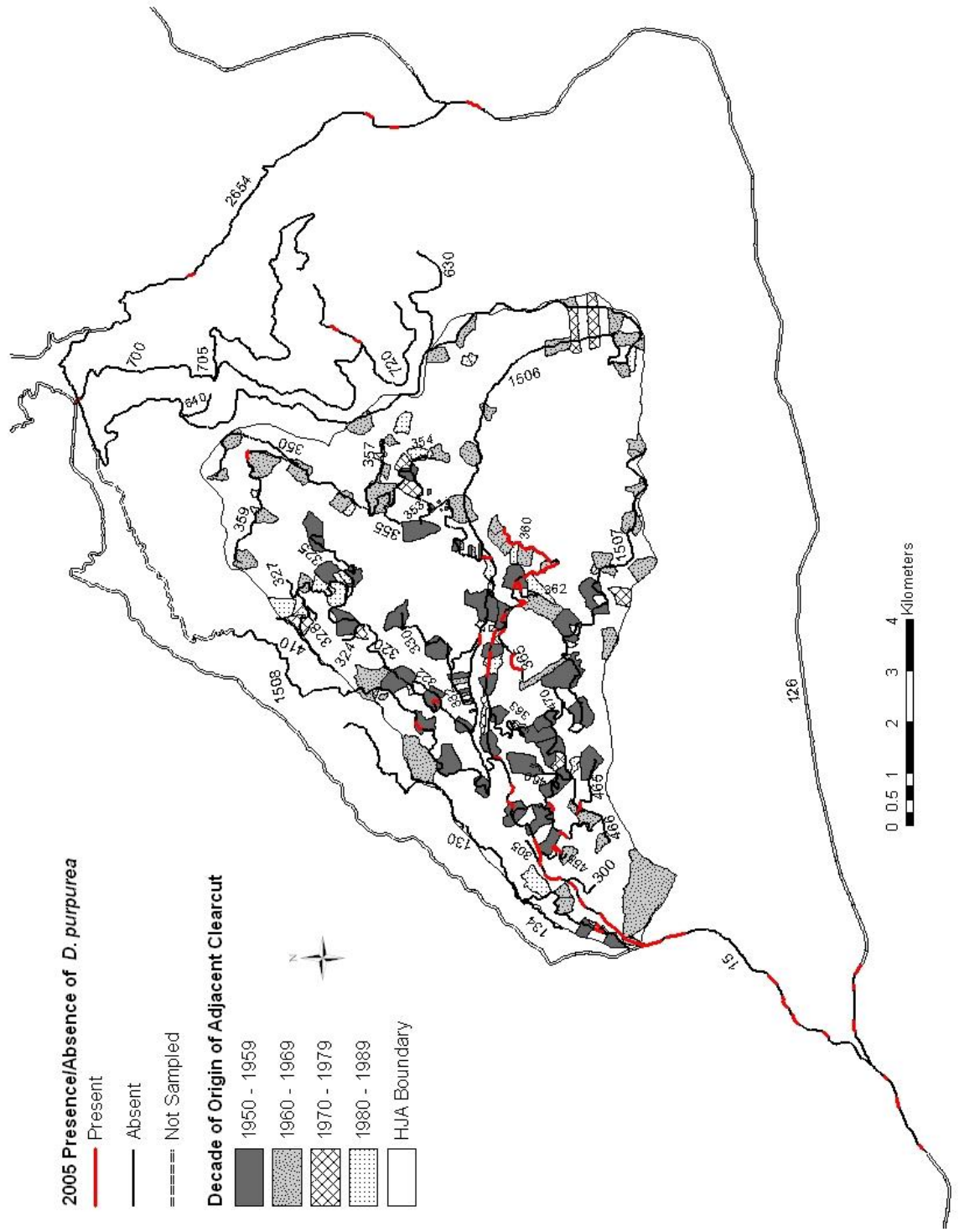

Figure 15. Distribution of *R. discolor* at the H.J. Andrews and Deer Creek drainage area.

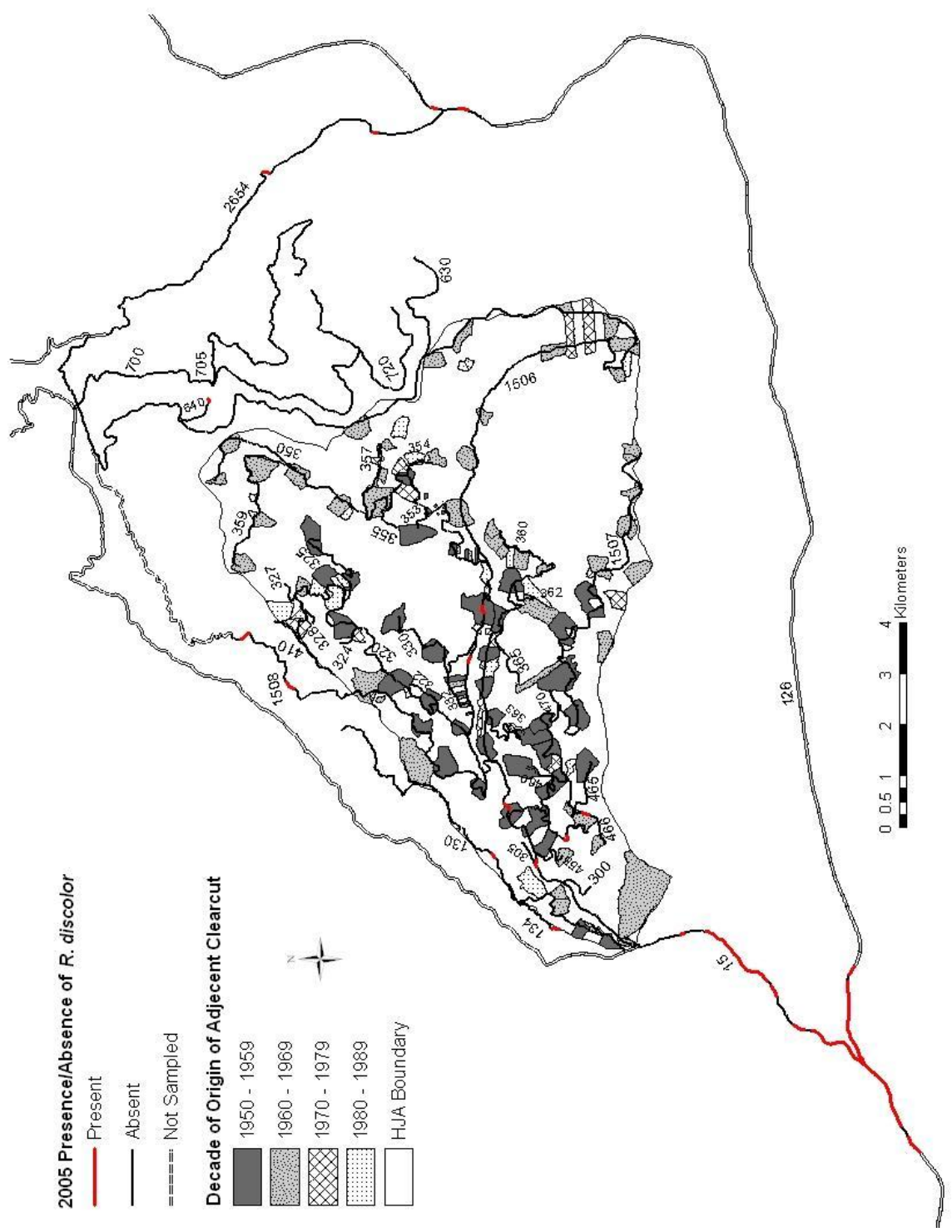
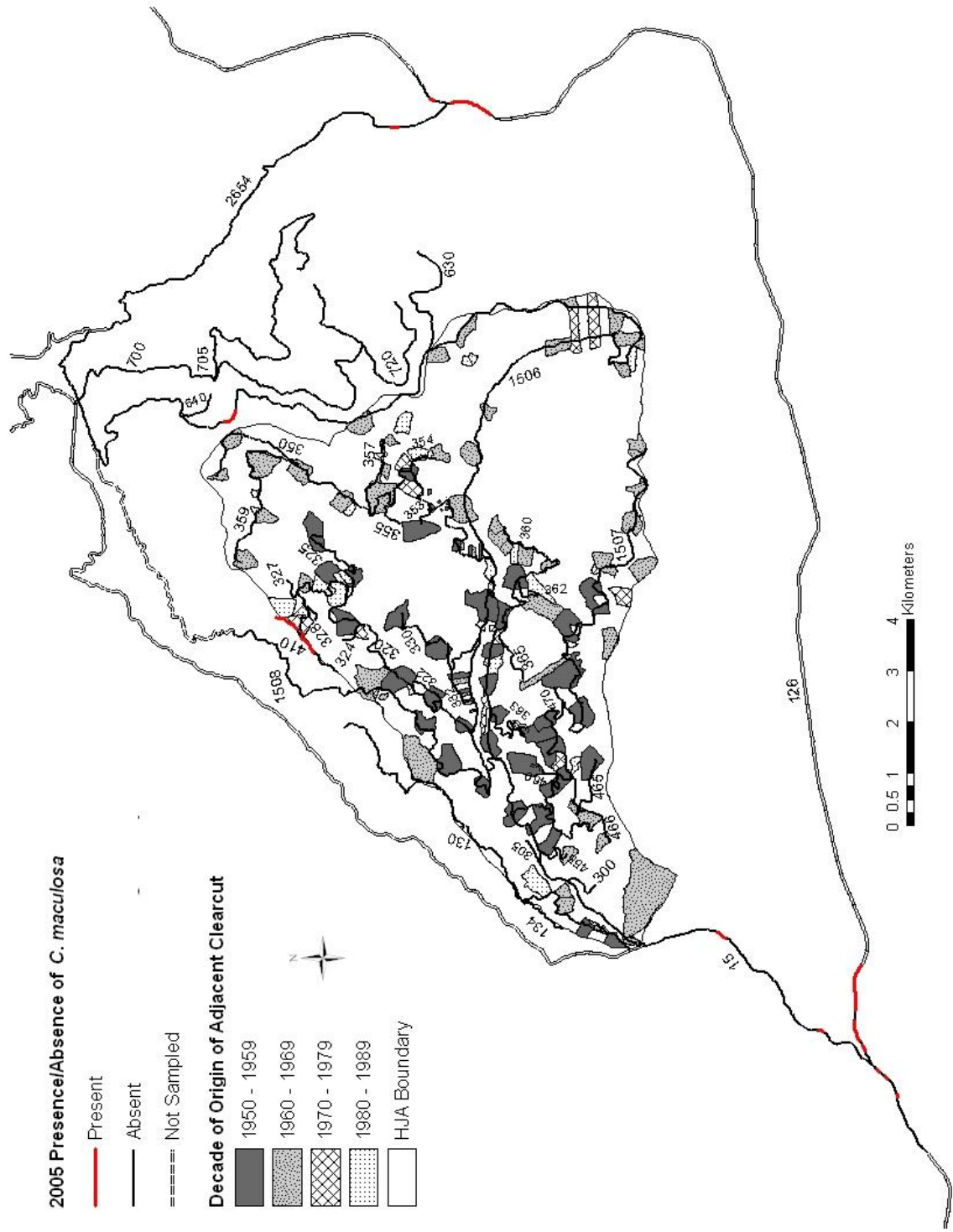

Figure 16. Distribution of *C. maculosa* at the H.J. Andrews and Deer Creek drainage area.



Relative Abundance of Selected Species

The four exotic species selected to analyze relative abundance demonstrated various densities and spatial patterns along the road network at both the H.J. Andrews and in the surrounding Deer Creek basin (Table 4).

Table 4. Total length (km) and percent network cover (based on presence/absence at 0.16-km intervals) of colonized road segments by relative abundance class for the H.J. Andrews and Deer Creek basins, and the H.J. Andrews alone. Relative abundance was defined on a logarithmic scale, such that rare = 1 to 10 plants per 0.16-km segment, common = 11 to 100 plants per 0.16-km segment, and abundant = greater than 101 plants per 0.16-km segment.

Species	Length (km)			Total Length of Occurrence (km)	Total Length of Network Surveyed	Percent of Total Length of Network Surveyed			Total Percent of Occurrence on Network Surveyed
	Rare	Common	Abundant			Rare	Common	Abundant	
<i>C. scoparius</i>									
HJA only	11.8	4.8	1.9	18.5	104.2	11.3	4.6	1.8	17.8
HJA + Deer Creek	19.0	11.3	4.7	35.0	169.5	11.2	6.7	2.8	20.6
<i>D. purpurea</i>									
HJA only	5.5	3.1	0.3	8.9	104.2	5.3	3.0	0.3	8.5
HJA + Deer Creek	9.5	3.9	0.5	13.9	169.5	5.6	2.3	0.3	8.2
<i>R. discolor</i>									
HJA only	0.8	1.0	0.0	1.8	104.2	0.8	1.0	0.0	1.7
HJA + Deer Creek	3.8	5.1	4.4	13.3	169.5	2.2	3.0	2.6	7.8
<i>B. sylvaticum</i>									
HJA only	4.5	4.0	2.1	10.6	104.2	4.3	3.8	2.0	10.2
HJA + Deer Creek	5.1	5.6	3.4	14.1	169.5	3.0	3.3	2.0	8.3

C. scoparius and *D. purpurea* demonstrated similar trends in relative abundance, in that the majority of presence on the entire road network was classified as rare (11.3 % for *C. scoparius*; 5.5% for *D. purpurea*), followed in frequency by classification as common (6.6% for *C. scoparius*; 2.3% for *D. purpurea*), followed by classification as abundant (2.8% for *C. scoparius*; 0.3% for *D. purpurea*) (Table 4). This decreasing trend in frequency from rare to abundant was also observed for the

H.J. Andrews only, as the majority of the presence on the H.J.A. road network was classified as rare for both species (11.3% for *C. scoparius*; 5.3% for *D. purpurea*). Outside of the H.J. Andrews Forest, *C. scoparius* is abundant on road 15, mostly common on Hwy 126 south of the H.J. Andrews, and rare on Hwy 126 east of the H.J. Andrews and on roads in Deer Creek (Figure 17). Within the H.J. Andrews, *C. scoparius* was common or abundant at the end of road 1508, the middle of road 320, and the segment of 1506 which runs by the gravel quarry. *C. scoparis* was rare at all other locations within the H.J. Andrews.

Outside of the H.J. Andrews, *D. purpurea* is common on a few segments of road 15, but is rare at all other locations (Figure 18). Within the H.J. Andrews, *D. purpurea* was abundant or common at the middle and end of road 360, common on the first few kilometers of road 1506, and rare on segments separating the abundant and common locations of road 360.

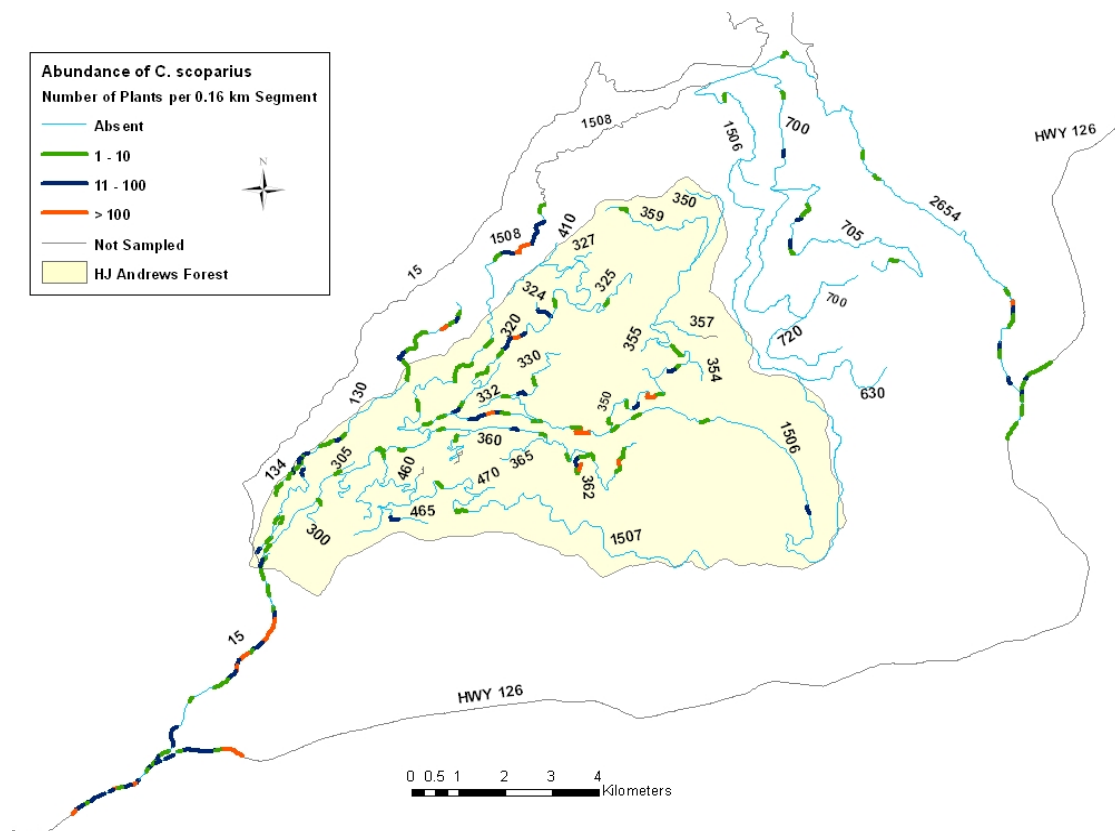

Figure 17. Landscape pattern of relative abundance of *C. scoparius* at the H.J. Andrews and Deer Creek Basin areas.

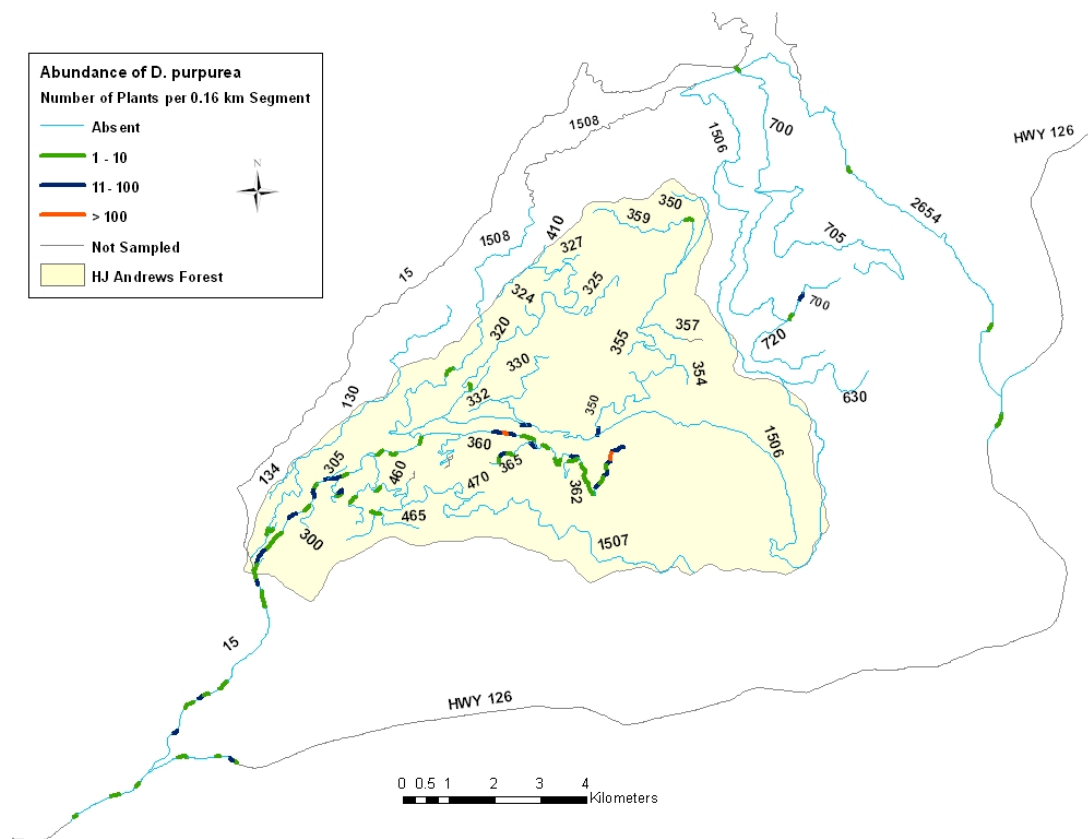

Figure 18. Landscape pattern of relative abundance of *D. purpurea* at the H.J. Andrews and Deer Creek Basin areas.

R. discolor and *B. sylvaticum* demonstrated a more equal distribution of relative abundance estimates on the road network (Table 4). *R. discolor* was rare on 2.1% of the entire network, common on 2.9% of the entire network, and abundant on 2.7% of the entire network; however, within the H.J. Andrews only, *R. discolor* not abundant on any portion of the road network. *R. discolor* is abundant on Hwy 126 south of the H.J. Andrews, but nowhere abundant within the H.J. Andrews (Figure 19). *R. discolor* is common on road 15, but rare on the few segments on which it occurs on Hwy 126 east of the H.J. Andrews and on the roads in Deer Creek Basin. Segments of *R. discolor* are randomly distributed on the H.J. Andrews road network,

and there is almost equal distribution of rare and common presence (0.7% and 1.0% of the H.J. Andrews road network, respectively).

In contrast, *B. sylvaticum* demonstrated similar abundance frequencies both within and outside of the H.J. Andrews (Table 4). Most of the *B. sylvaticum* observed on the entire road network was concentrated within the H.J. Andrews boundary, except that it was abundant or common at the beginning of road 2654 in the Deer Creek Basin, and abundant for a kilometer on road 15 just south the junction with road 130, which leads to the H.J. Andrews headquarters (Figure 20). *B. sylvaticum* occurred as rare, common and abundant throughout the H.J. Andrews road network. Occurrence was abundant or common along several kilometers of road 1506 near the mouth of the watershed and entrance to the experimental forest.

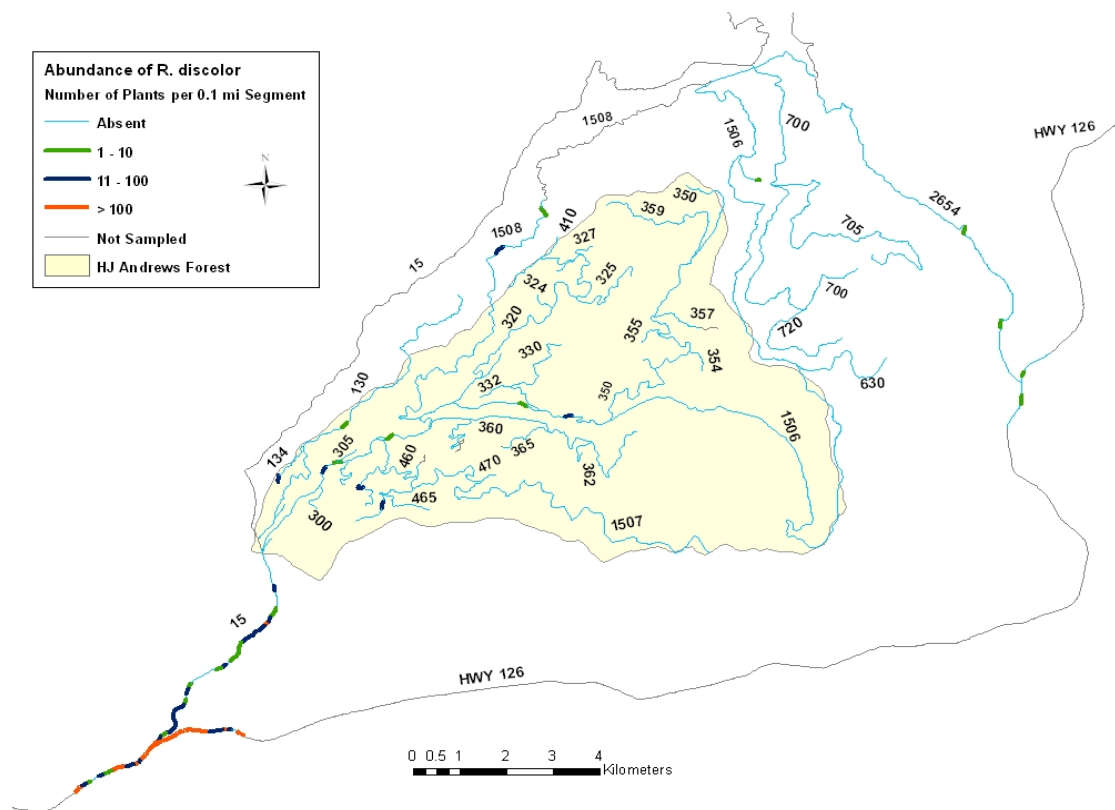

Figure 19. Landscape pattern of relative abundance of *R. discolor* at the H.J. Andrews and Deer Creek basin areas.

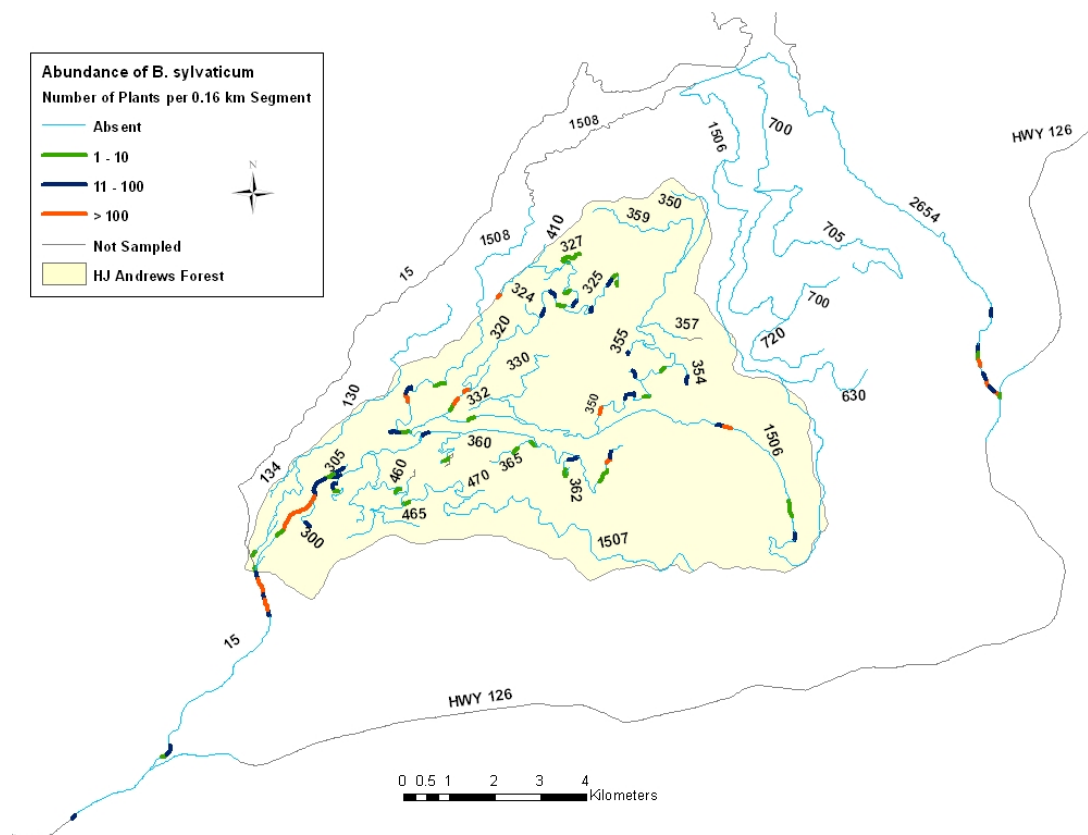

Figure 20. Landscape pattern of relative abundance of *B. sylvaticum* at the H.J. Andrews and Deer Creek basin areas.

Analysis of Spatial Pattern in 2005

Spatial analysis of standardized semivariograms for exotic species distributions in 2005 did not reveal any preferred scale of patch size for the eight species evaluated (Figures 21-28). For some species that were discontinuously distributed on particular roads, such as *C. leucanthemum* on road 700 (Figure 22), *C. vulgare* on road 15 (Figure 24), and *C. scoparius* on road 130 (Figure 25), some patchiness is evident as the presence of a range on the semivariograms, and by visual inspection of the distribution on the maps, but patch size was not consistent either by species or by road. It is interesting to note that *C. scoparius* had evidence of a patch size of 0.4 km on

road 350, and 0.6 km on road 130, which roughly correlates to the average size of the clearcut units on these roads, which range from 0.2 to 0.6 km on road 350, and from 0.4 to 1.0 km on road 130 (Figure 10).

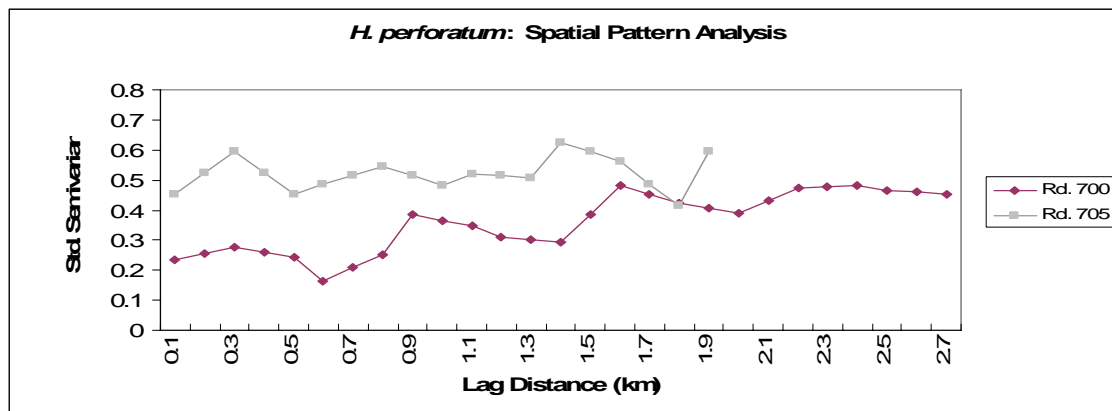

Figure 21. Standardized semivariogram for *H. perforatum* at the H.J. Andrews and Deer Creek Basin area in 2005.

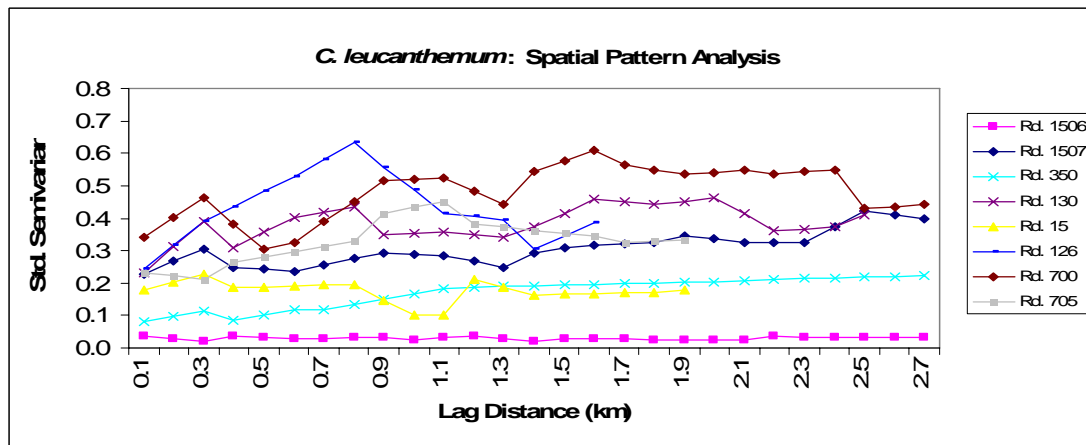

Figure 22. Standardized semivariogram for *C. leucanthemum* at the H.J. Andrews and Deer Creek Basin area in 2005.

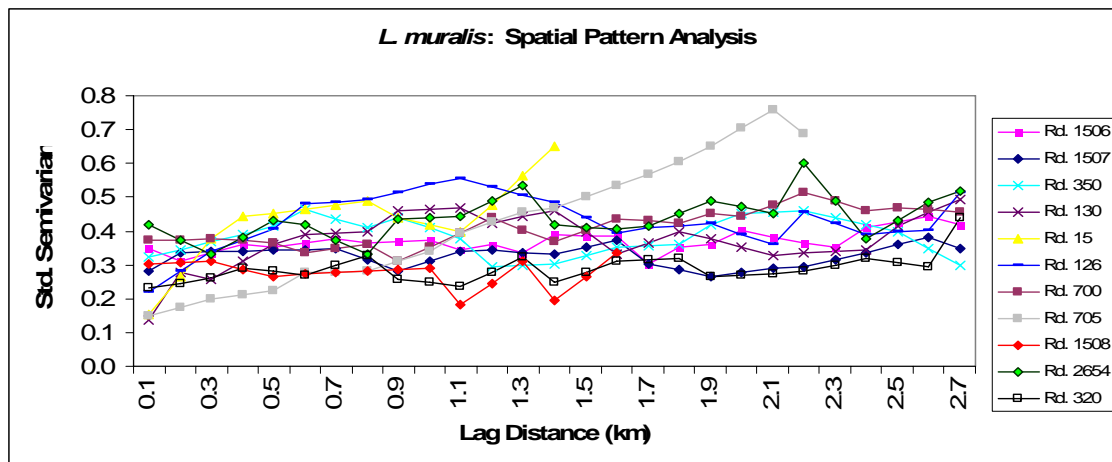

Figure 23. Standardized semivariogram for *L. muralis* at the H.J. Andrews and Deer Creek Basin area in 2005.

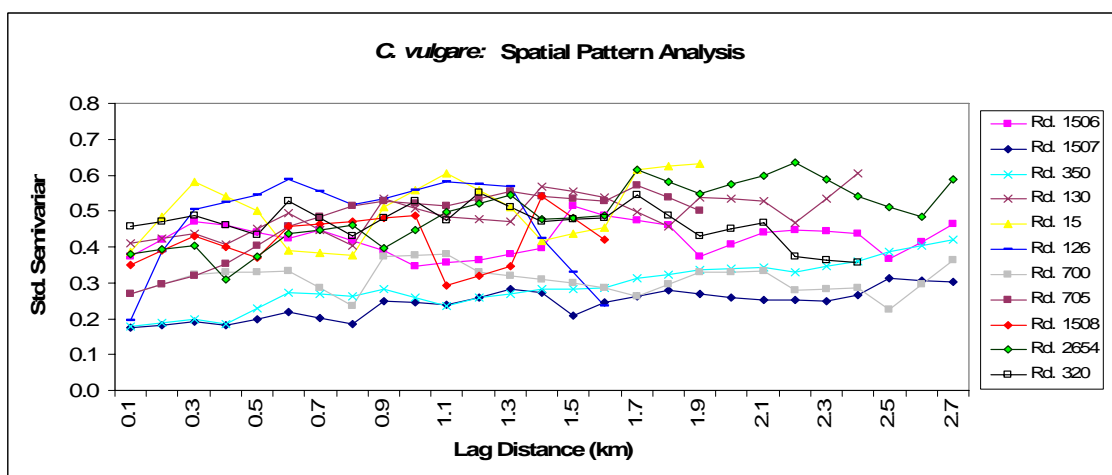

Figure 24. Standardized semivariogram for *C. vulgare* at the H.J. Andrews and Deer Creek Basin area in 2005.

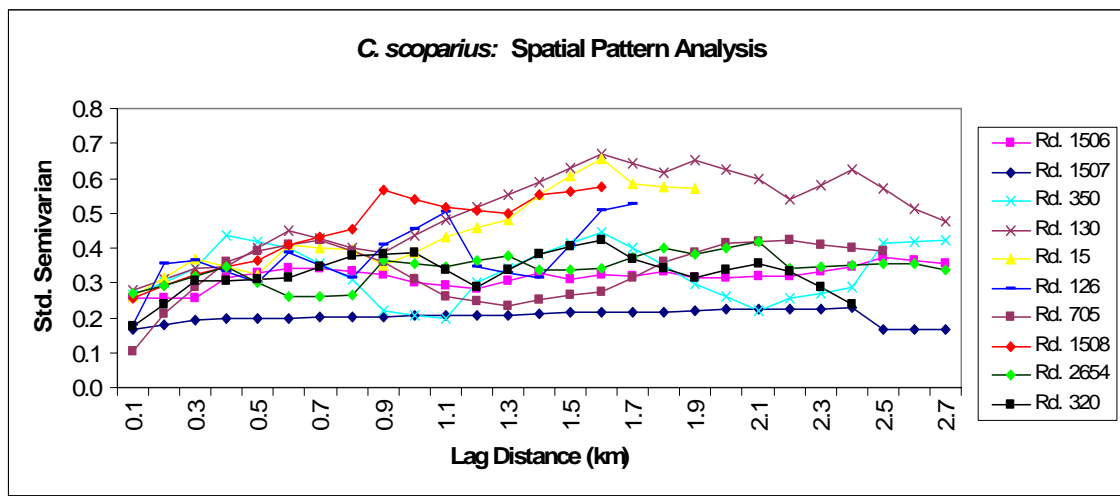

Figure 25. Standardized semivariogram for *C. scoparius* at the H.J. Andrews and Deer Creek Basin area in 2005.

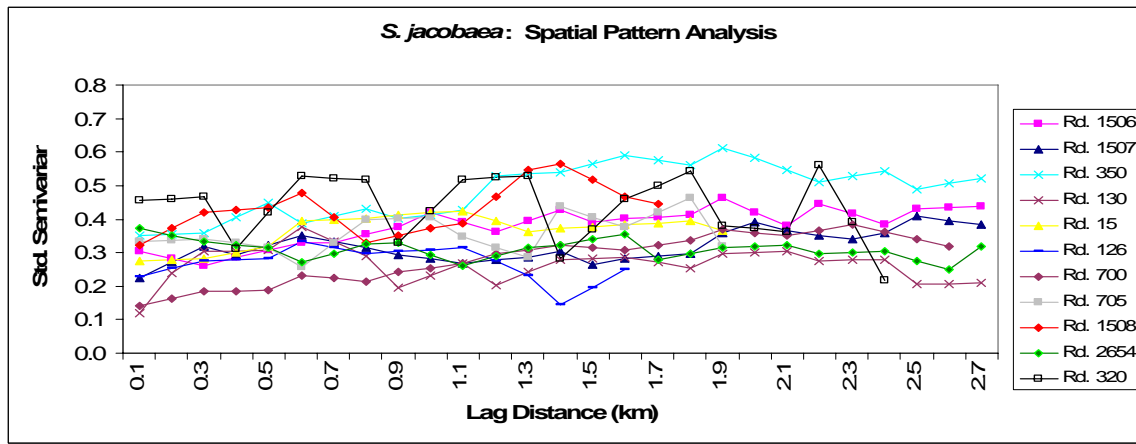

Figure 26. Standardized semivariogram for *S. jacobaea* at the H.J. Andrews and Deer Creek Basin area in 2005.

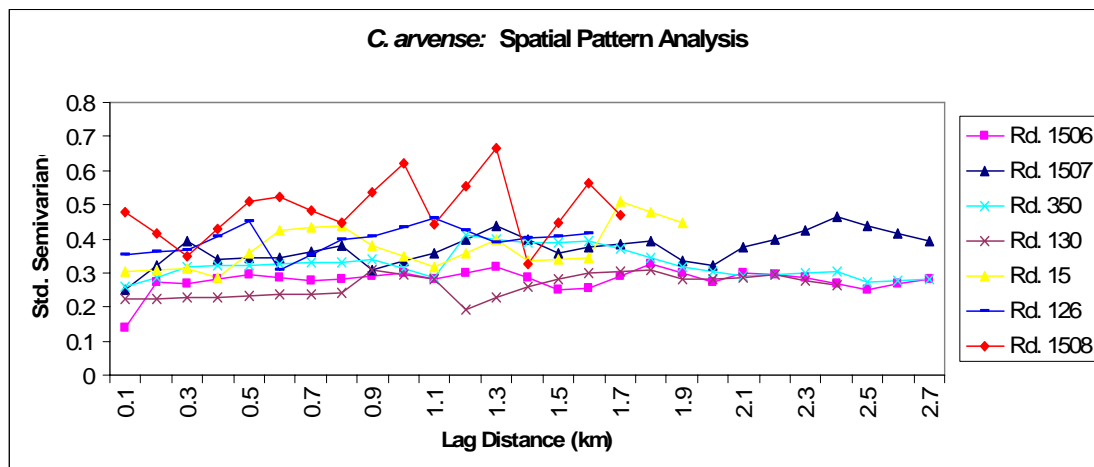

Figure 27. Standardized semivariogram for *C. arvensis* at the H.J. Andrews and Deer Creek Basin area in 2005.

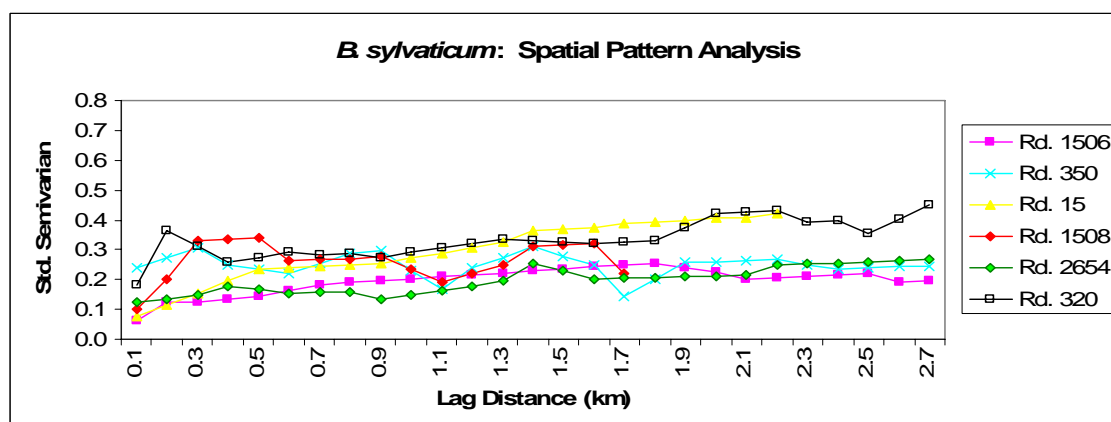

Figure 28. Standardized semivariogram for *B. sylvaticum* at the H.J. Andrews and Deer Creek Basin area in 2005.

Species distributions were heterogeneously distributed at the landscape scale, as demonstrated by their different levels of variability on different portions of the road network (Table 5). Semivariance values approximately ranged between 0.01 and 7.0 units, so variability on a road was considered high if the sill was above 0.35 units, medium if the sill was approximately 0.35 units, and low if the sill was below 0.35 units.

Table 5. Variability in presence/absence of target species sampled in 2005 according to semivariogram analysis.

Frequency	Road #	H. J. Andrews Roads						Dear Creek Basin Roads				
		126	15	1506	360	1507	1508	130	320	360	700	705
	Location	Valley	Valley	Valley	South Side	South Side	North Side	North Side	North Side	East Ridge	East Ridge	Valley
Very Common	<i>H. perforatum</i>	-	-	-	-	-	-	-	-	med	high	-
Very Common	<i>C. leucanthemum</i>	high	low	low	-	low	med	-	low	high	med	-
Very Common	<i>L. muralis</i>	high	high	med	-	med	med/high	low	med	med/high	low to high (gradient)	high
Intermediate	<i>C. vulgare</i>	high	high	high	high	low	high	high	low	med/low	high	high
Intermediate	<i>S. jacobaea</i>	low	med	med	-	low	low	high	high	low	med	med
Intermediate	<i>C. scoparius</i>	med	med/high	low	-	low	high	med	med	-	med	med
Intermediate	<i>C. arvensis</i>	high	med	low	-	med	low	-	med	-	-	-
Less Common	<i>B. sylvaticum</i>	-	low	low	-	-	-	med-low	low	-	-	low

For the most frequently occurring species at the H.J. Andrews, distributions were continuous on many roads and thus variability in pattern was very low. *H. perforatum* was too continuous for spatial pattern to be evaluated on any of the H.J. Andrews Forest roads, where frequency on the network exceeds 98% (Table 3), but demonstrated medium to high variability on roads 700 and 705 in the Deer Creek Basin (Figure 21). *C. leucanthemum*, which is also almost continually distributed on the H.J. Andrews roads, had low variability on all H.J. Andrews roads except for road 130, on which variability was medium (Figure 22). Outside of the H.J. Andrews, *C. leucanthemum* was highly variable on Hwy 126, and on roads 700 and 705 in the Deer Creek basin, but had low variability on road 15 leading up the to entrance of the H.J. Andrews Headquarters (Table 5).

L. muralis had medium and low variability on the road network at the H.J. Andrews, but was highly variable on the major roads of Hwy 126 and 15 outside of the H.J. Andrews (Table 5). Variability was also high for *L. muralis* on the roads in the Deer Creek Basin, and some evidence of a spatial gradient was evident on road 705 (Figure 23).

C. vulgare was highly variable on most roads in the H.J. Andrews, with the exception of road 1507 on the south side, and 350 on the north side (Table 5). Variability was also high on the major roads of Hwy 126, and on the roads 2654 and 700 in the Deer Creek Basin (Figure 24).

S. jacobaea, *C. scoparius*, and *C. arvense* had no consistent trend of variability on the roads at the H.J. Andrews (Figures 25-27). *S. jacobaea* had high variability on the north side roads of 1508, 320, and 350, but low variability on the north side road

130 and the south side road 1507 (Table 5). *C. scoparius* had high variability on the north side roads of 1508 and 130, and low variability on 1506 and the south side road of 1507. *C. arvense* was highly variable on road 1508, and had low variability on 1506 and 130. Outside of the H.J. Andrews, variability of *S. jacobaea* and *C. scoparius* was low or medium on Hwy 126, road 15, and the roads in the Deer Creek Basin (Table 5). *C. arvense* was not evaluated on the Deer Creek roads, but demonstrated high and medium variability on Hwy 126 and 15, respectively.

B. sylvaticum had low variability on all roads sampled, with the exception of road 320, on which variability was medium-low (Figure 27, Table 5).

Very few trends in spatial pattern were evident based on different roads. In the H.J. Andrews, the south side road 1507 demonstrated low variability for many species sampled, while variability was predominantly high for species on the north side road 1508, but all other roads showed diverse spatial patterns for individual species. Outside of the H.J. Andrews, variability was generally high on Hwy 126, and medium or high on roads 2654, 700, and 705 in the Deer Creek Basin (Table 5).

Change in Species Distributions from 1994 to 2005 at the H.J. Andrews

The eight exotic species surveyed in both 1994 and 2005 demonstrated different dynamic changes over the eleven-year period. Table 6 summarizes the total length (km) of all present segments for each species in both years, the percent cover (based on presence/absence at 0.16-km intervals) in both years, as well as the percent increase, percent decrease, and percent net increase demonstrated by each species over time.

Table 6. Length and percent of road network in the H.J. Andrews Forest along which target exotic species were present in 1994 and 2005.

SPECIES	A 1994 Presence (km)	B 1994 Percent Cover	C 2005 Presence (km)	D 2005 Percent Cover	E Percent of Segments on Which Species was Absent in 1994 and Present in 2005	F Percent of Segments on Which Species was Present in 1994 and Absent in 2005	E-F Percent Net Increase (Percent Increase– Percent Decrease)
<i>Hypericum perforatum</i>	98.0	94.0	102.8	98.7	6.1	0.3	5.8
<i>Chrysanthemum leucanthemum</i>	81.9	78.5	96.2	92.3	15.8	1.1	14.7
<i>Cirsium vulgare</i>	75.0	71.9	54.1	51.9	6.2	26.2	-20.0
<i>Senecio jacobaea</i>	31.5	30.2	34.4	33.0	16.0	12.6	3.4
<i>Cirsium arvense</i>	16.9	16.2	15.8	15.2	7.9	9.1	-1.2
<i>Cytisus scoparius</i>	11.8	11.3	18.3	17.6	8.5	2.5	6.0
<i>Digitalis purpurea</i>	0.8	0.8	8.9	8.5	7.6	0.0	7.6
<i>Rubus discolor</i>	0.5	0.5	1.6	1.5	1.2	0.2	1.0
Total Kilometers	104.3		104.2				

Spatial patterns of the distribution change on the road network over time can be categorized into different groupings, based on their similarities. *C. leucanthemum*, in a category all its own, increased 14.7% (net) from 1994, covering up to 92.3% of the entire road network of the H.J. Andrews in 2005 (Table 6). *C. leucanthemum* decreased on only 1.1% of the network, so the 1994 distribution remained fairly static with a large expansion into new areas. Most newly colonized segments are located in previously absent segments between continuous stretches in 1994, so *C.*

leucanthemum has filled in some patchy areas over the 11-years, especially at the ends of roads, resulting in almost continuous coverage of the road network in 2005 (Figure 29).

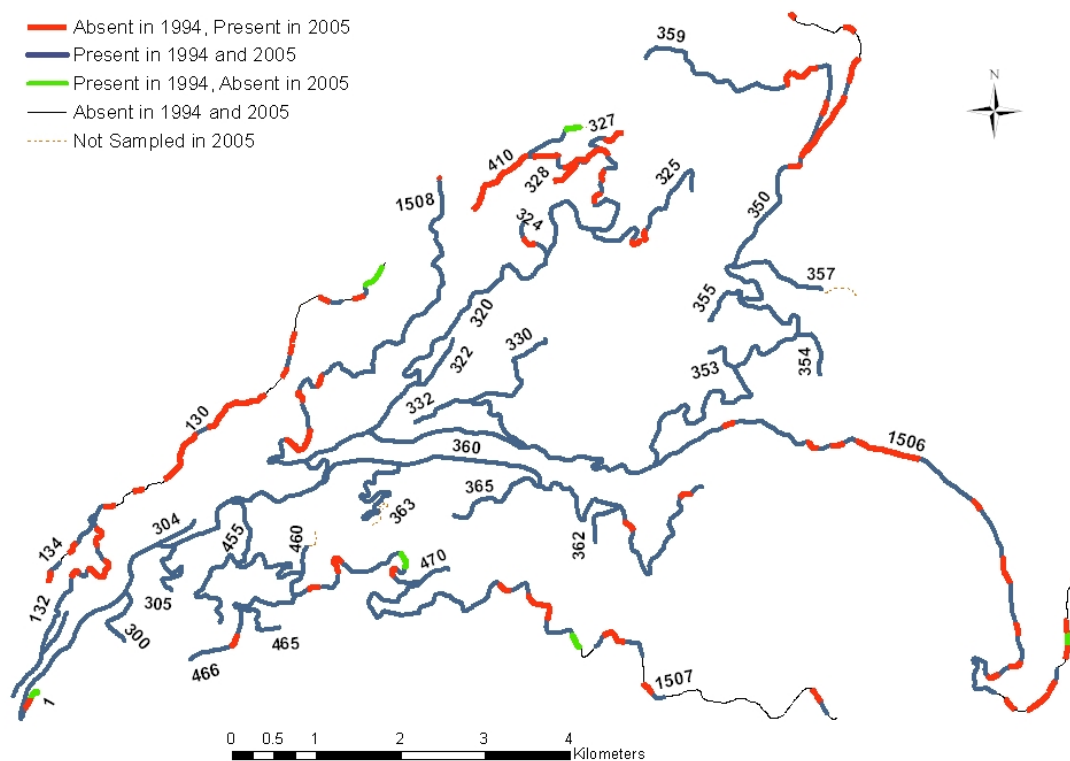

Figure 29: Change in distribution of *C. leucanthemum* on the H. J. Andrews Road Network from 1994 to 2005.

A second group of species, *D. purpurea*, *C. scoparius*, and *H. perforatum*, increased on 5% to 8% of the road network over the 11-year period (Table 6). Neither *D. purpurea* nor *H. perforatum* decreased on more than a kilometer of road network compared to 1994 (0.0% and 0.3%, respectively). Therefore, like *C. leucanthemum*, the net increase of these three species consists largely of increase with very little

decrease in presence on the network. *D. purpurea*'s increase was focused in two specific places: on roads 1506 and 360 (Figure 30). Over the 11-year period, *D. purpurea* has expanded from a few, discontinuous segments to almost continuous coverage along the end half of road 360 and the first few kilometers of road 1506, and new patches of *D. purpurea* have become established along the spur roads branching from these main roads, such as on roads 465, 305, and 350. In contrast, *H. perforatum* increased by filling in the absent gaps at the ends of roads, expanding its already nearly complete distribution to 98.6% of the entire H.J. Andrews road network (Figure 31). The changes in distribution of *C. scoparius* were dynamic; *C. scoparius* increased on 8.5% and decreased on 2.5% of the road network, with a net increase of 6.0% (Table 6). Patches of *C. scoparius* that were present in 1994 expanded, while some patches contracted (Figure 32). In the majority of cases, decrease was a result of the disappearance of discontinuous, small patches that were randomly located on the road network in 1994, such as those previously located on roads 470, 410, and 132.

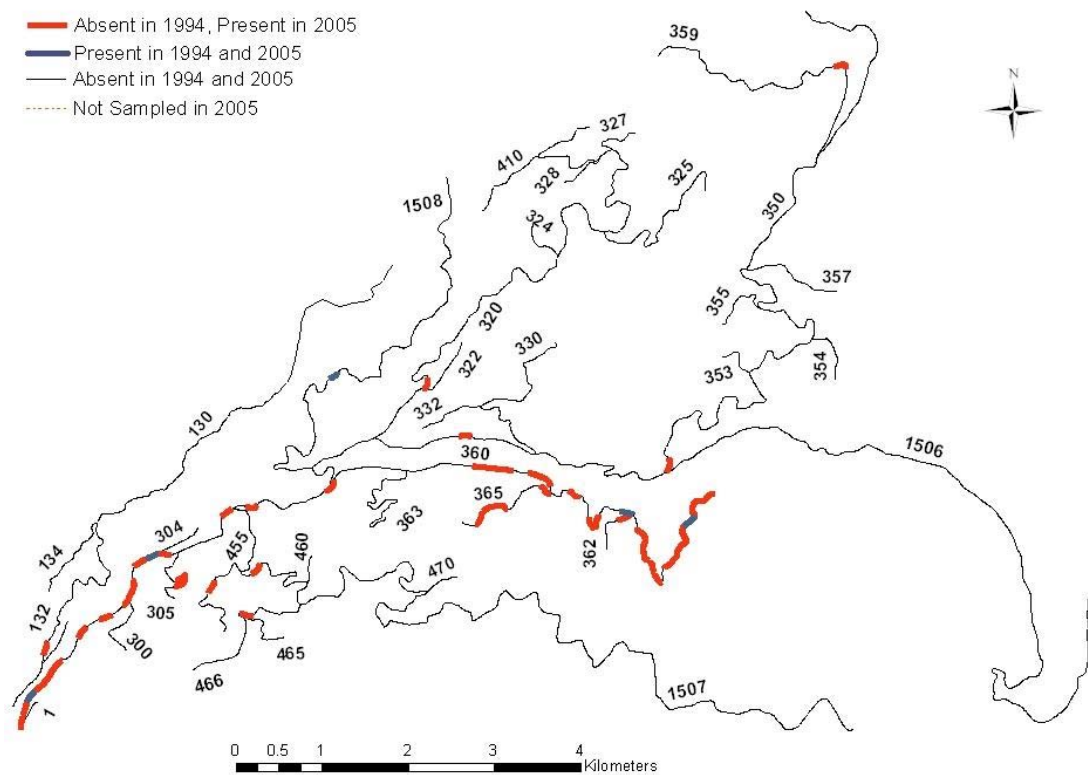

Figure 30. Change in distribution of *D. purpurea* on the H. J. Andrews Road Network from 1994 to 2005.

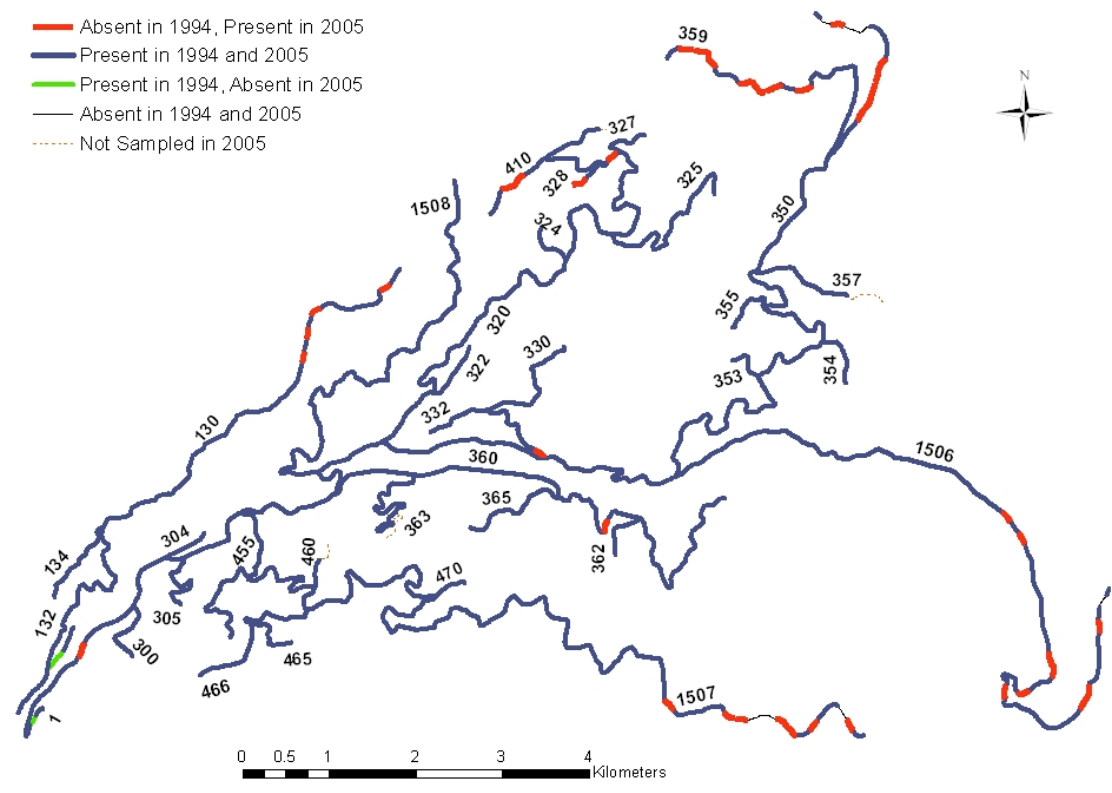

Figure 31. Change in distribution of *H. perforatum* on the H. J. Andrews Road Network from 1994 to 2005.

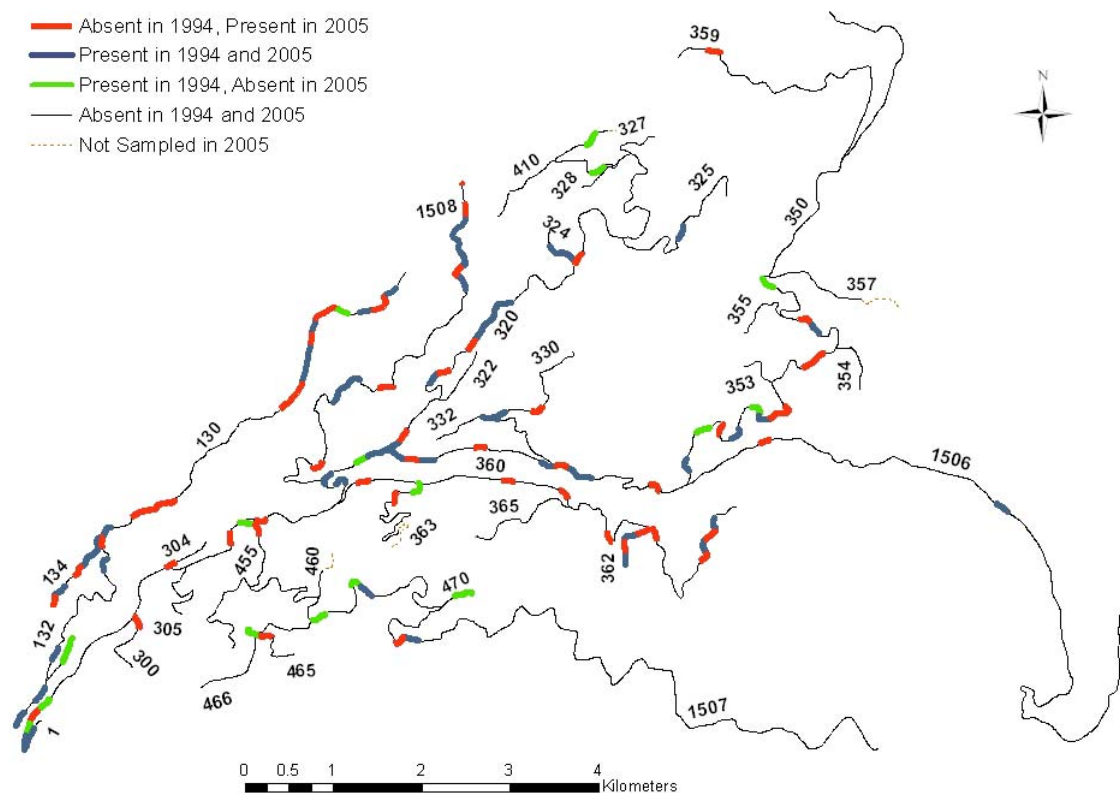

Figure 32. Change in distribution of *C. scoparius* on the H. J. Andrews Road Network, 1994 to 2005.

Two species, *S. jacobaea* and *R. discolor*, increased in net kilometers on small portions of the network (3.4% and 1.0%, respectively), but the gross changes of these species were quite different. *S. jacobaea* increased on more of the road network than any other species (16%), but it also decreased on 12.6% of the road network compared to 1994 (Table 6). *S. jacobaea* disappeared from all road segments in the center, valley roads, but new patches appeared at upper elevations (towards the end of roads 1506, 410, and 325) (Figure 33). Other changes are adjacent to road segments that demonstrated no change in presence/absence from 1994 to 2005. In contrast, *R.*

discolor increased and decreased on very small portions of the road network (1.0% and 0.2%, respectively). New patches of *R. discolor* were widely distributed over the entire road network, including colonies on lower elevation roads and the end of road 1508 (Figure 34).

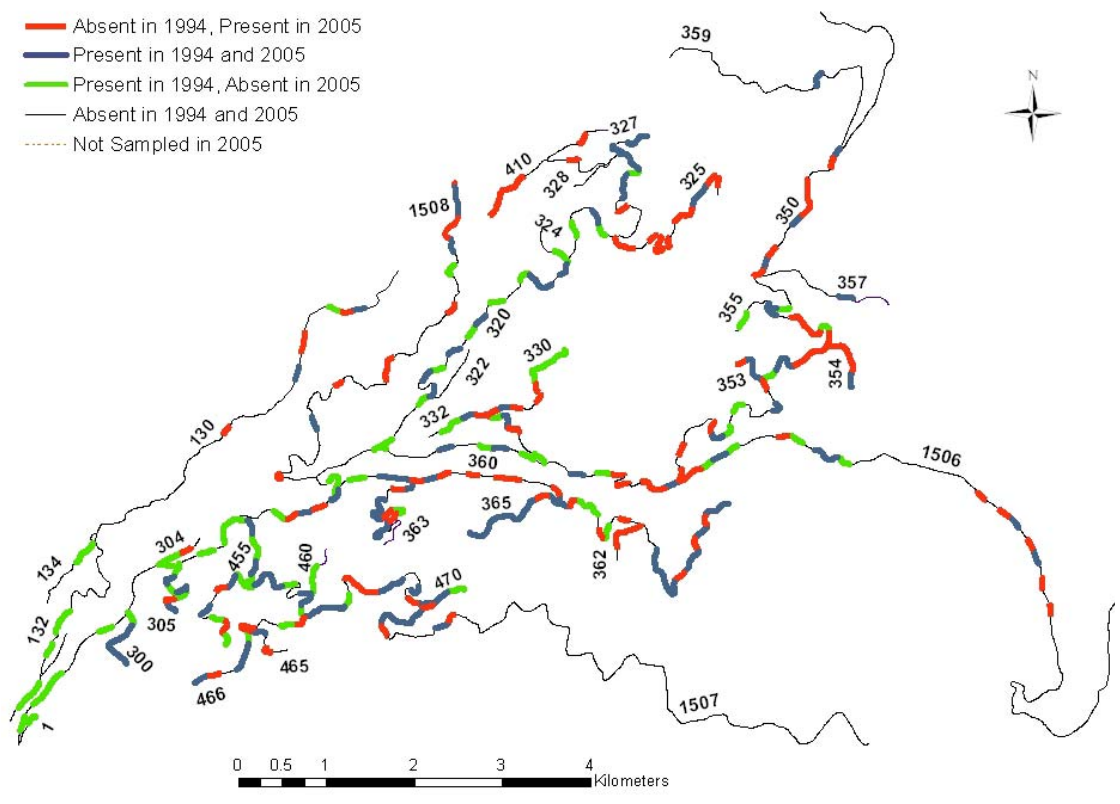

Figure 33. Change in distribution of *S. jacobaea* on the H. J. Andrews Road Network, 1994 to 2005.

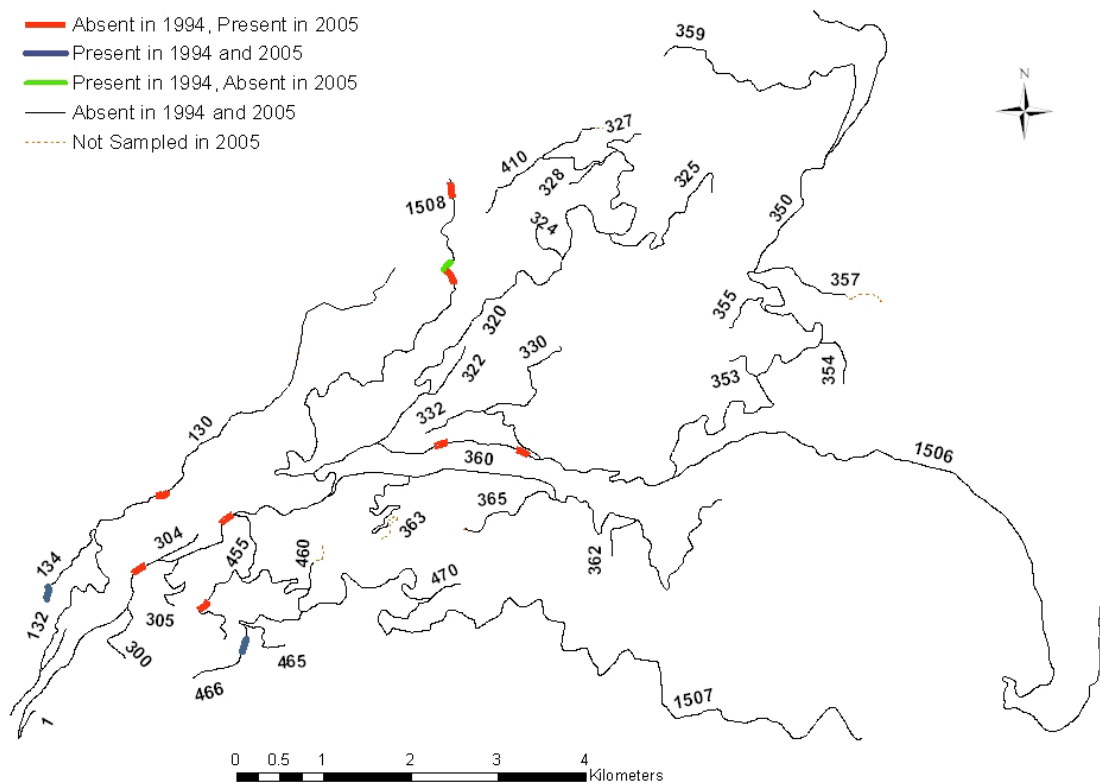

Figure 34. Change in Distribution of *R. discolor* on the H. J. Andrews Road Network, 1994 to 2005.

A third grouping of species decreased in net kilometers on the H.J. Andrews road from 1994 to 2005. *C. arvense* increased on 7.9% of the road network, but decreased on 9.1% of the road network (net decrease of 1.2%) (Table 6). Some discontinuously distributed present segments from 1994 have disappeared from the road network in 2005, and some road segments adjacent to sites of current presence in 2005 have also disappeared (Figure 35). Similarly, most locations of increase are near segments where the species was present in 1994. *C. vulgare* increased on 6.2% of the road network, but decreased on 26.2% of the road network (net decrease of 20%)

(Table 6). *C. vulgare* disappeared on upper elevation roads such as 1507, 350, and 410, as well on segments adjacent to segments demonstrating no change from 1994 to 2005 (Figure 36). Similarly, increases occurred adjacent to either static patches (no change from 1994 to 2005) or segments where the species had decreased (present in 1994, absent in 2005).

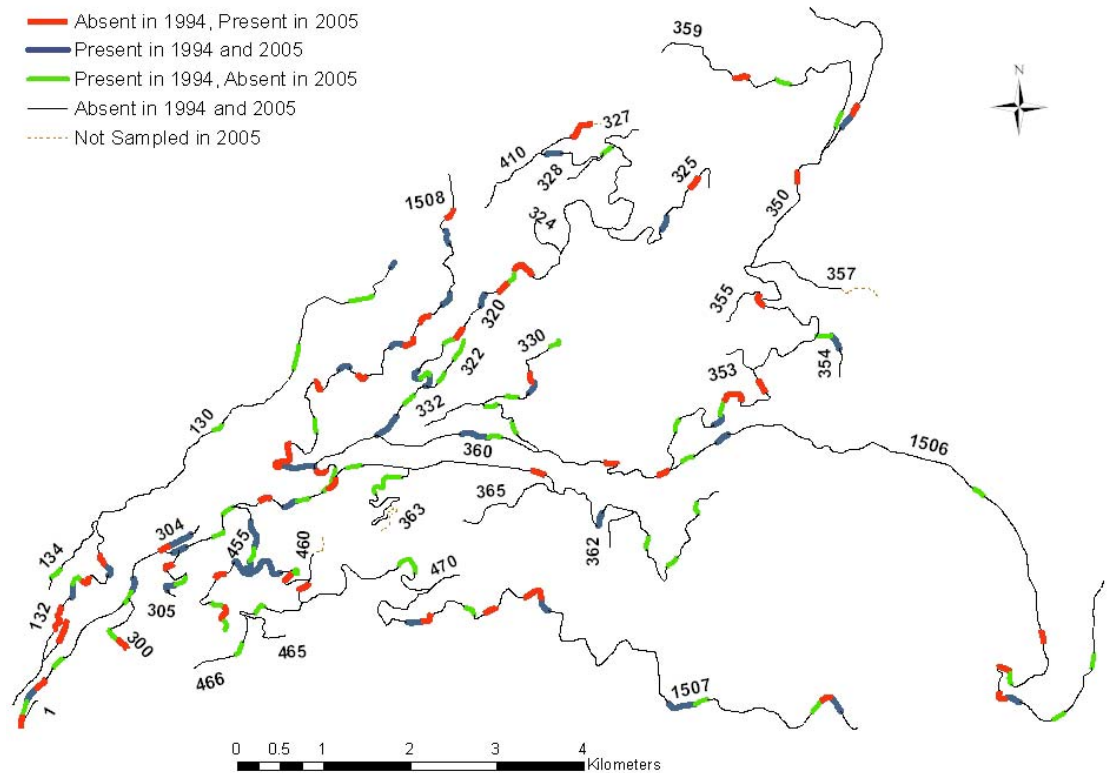

Figure 35. Change in distribution of *C. arvensis* on the H. J. Andrews Road Network from 1994 to 2005.

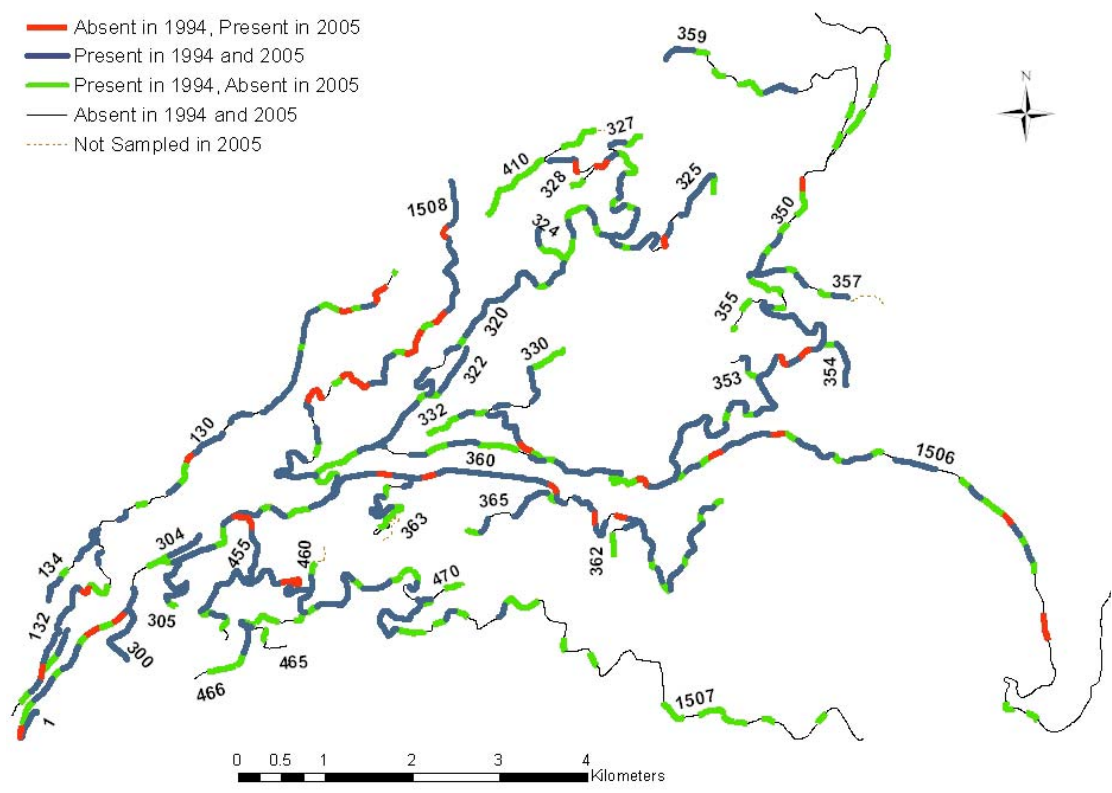

Figure 36. Change in Distribution of *C. vulgare* on the H. J. Andrews Road Network from 1994 to 2005.

Change in Spatial Distribution Pattern from 1994 - 2005

Standardized semivariograms for 1994 and 2005 were plotted on one graph for each road to compare differences in spatial pattern by year (Figures 37 – 71).

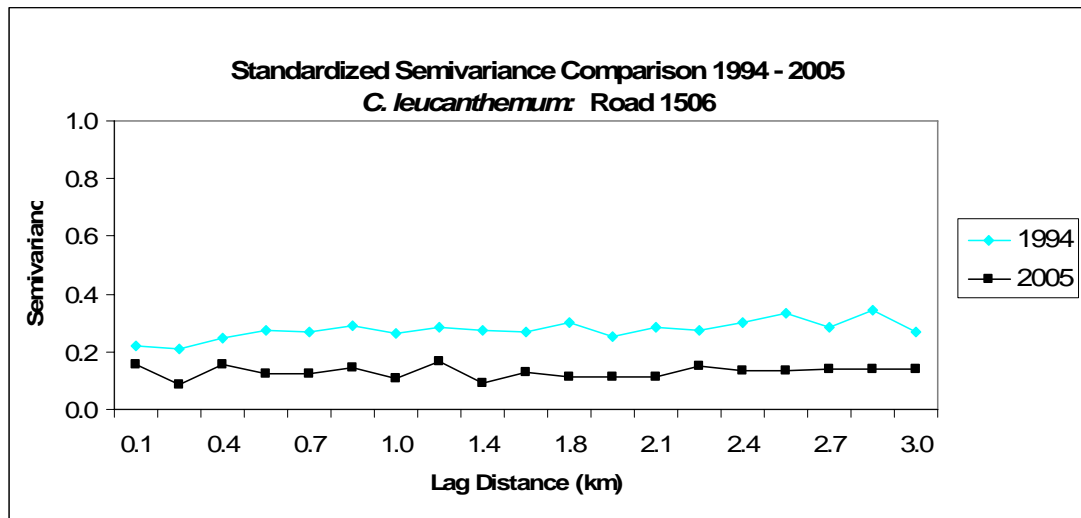

Figure 37. Standardized semivariance comparison from 1994 to 2005 for the presence of *C. leucanthemum* on road 1506.

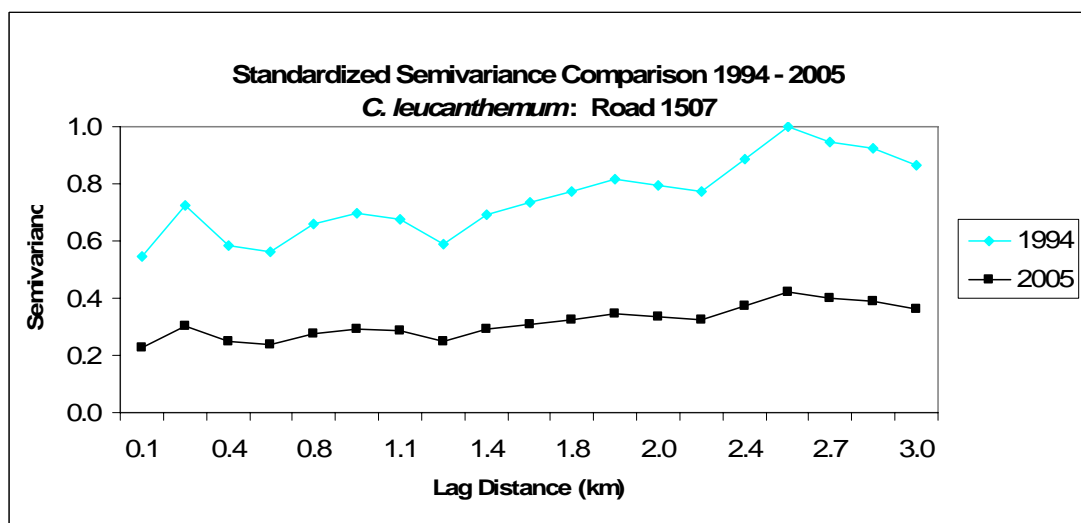

Figure 38. Standardized semivariance comparison from 1994 to 2005 for the presence of *C. leucanthemum* on road 1507.

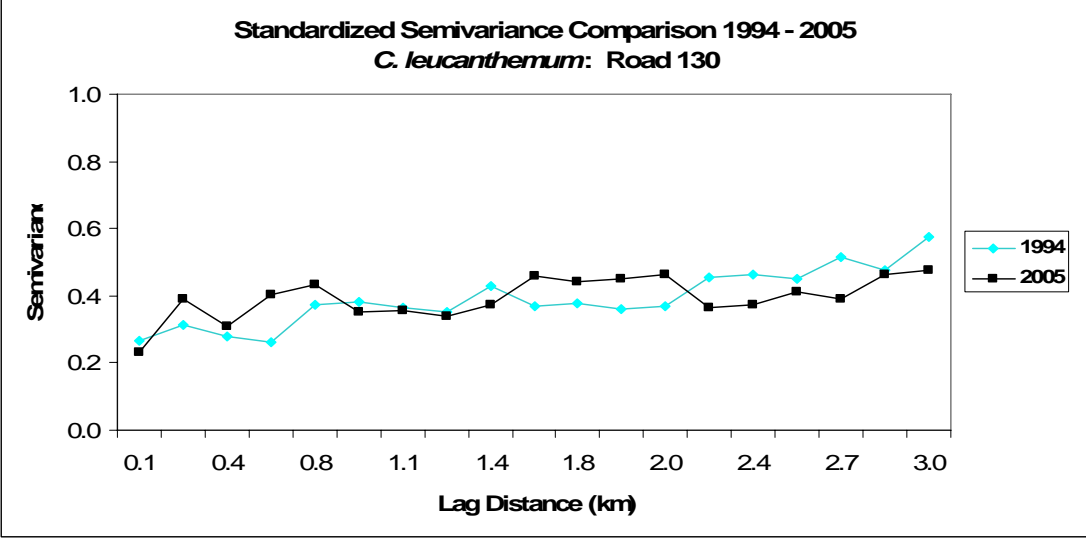

Figure 39: Standardized semivariance comparison from 1994 to 2005 for the presence of *C. leucanthemum* on road 130.

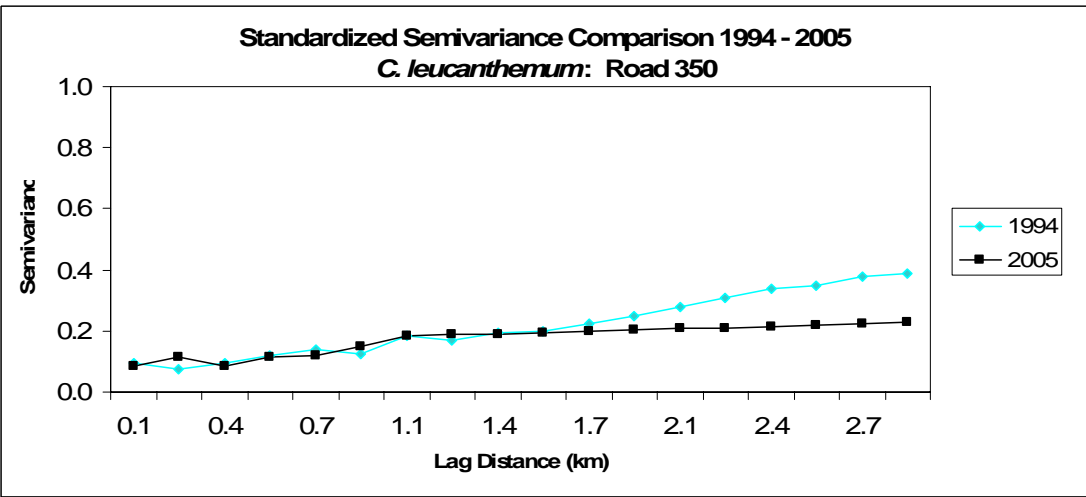

Figure 40: Standardized semivariance comparison from 1994 to 2005 for the presence of *C. leucanthemum* on road 350.

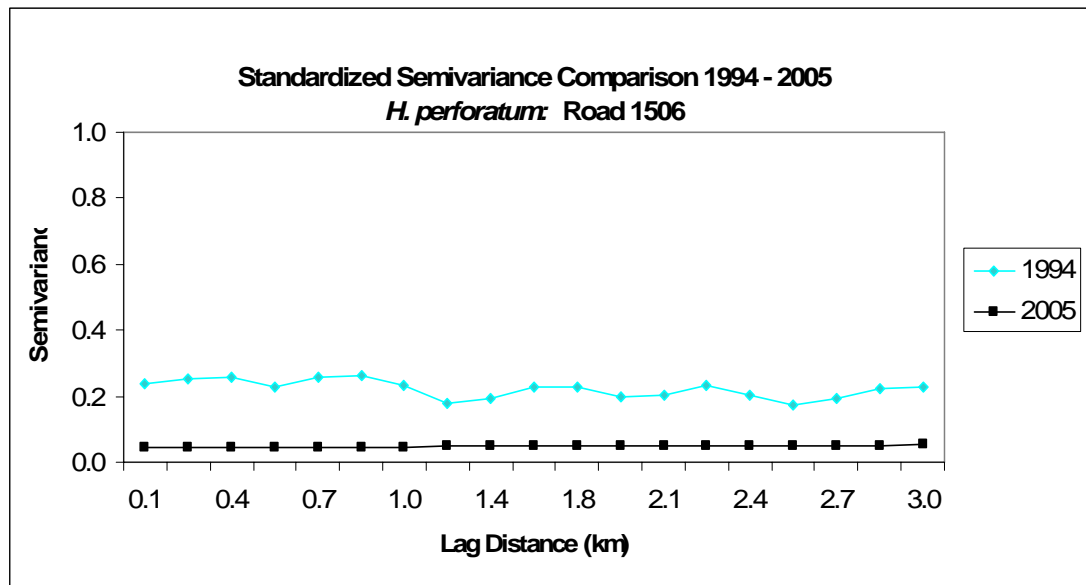

Figure 41. Standardized semivariance comparison from 1994 to 2005 for the presence of *H. perforatum* on road 1506.

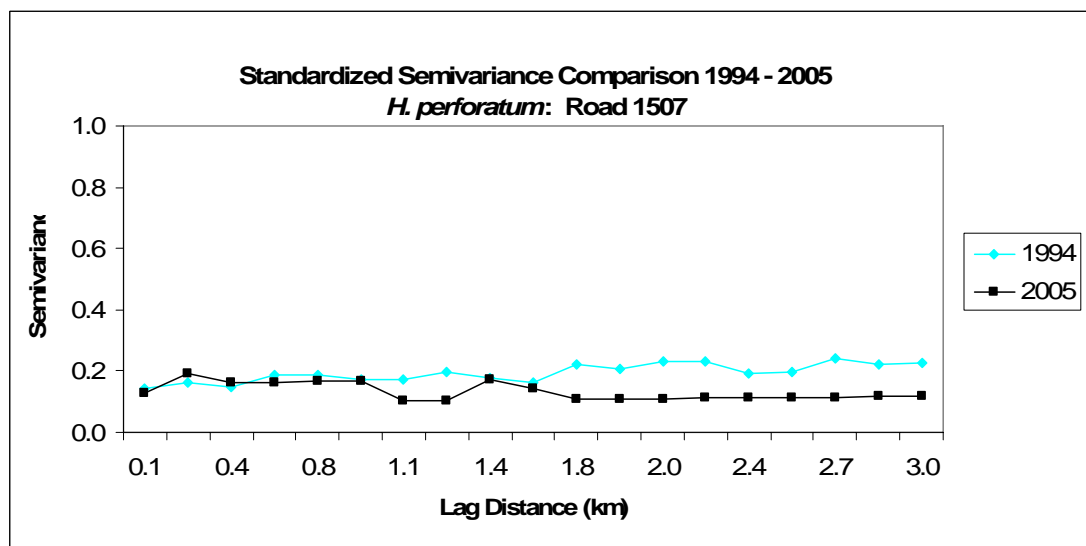

Figure 42: Standardized semivariance comparison from 1994 to 2005 for the presence of *H. perforatum* on road 1507.

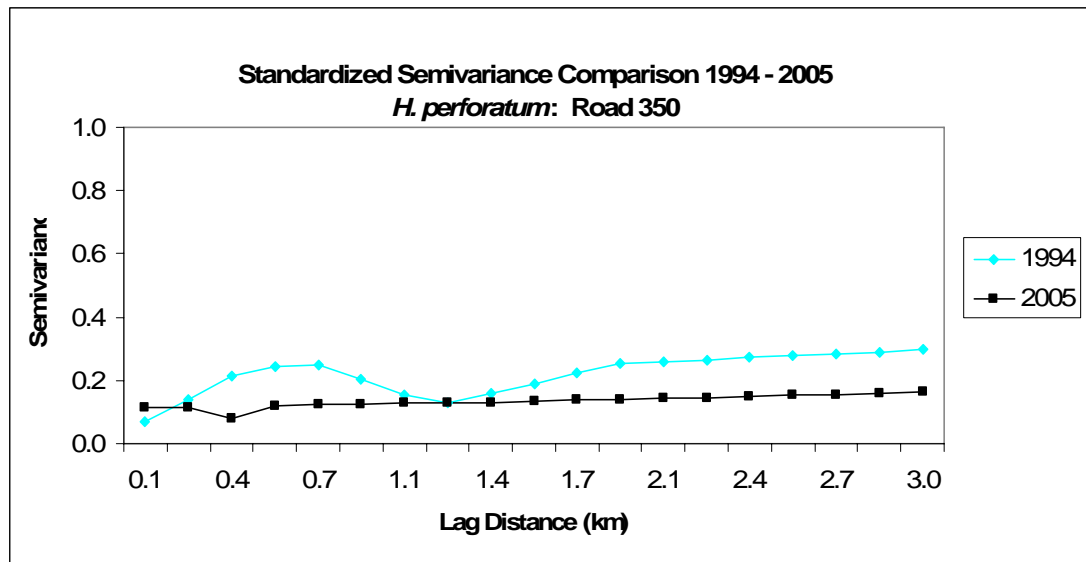

Figure 43: Standardized semivariance comparison from 1994 to 2005 for the presence of *H. perforatum* on road 350.

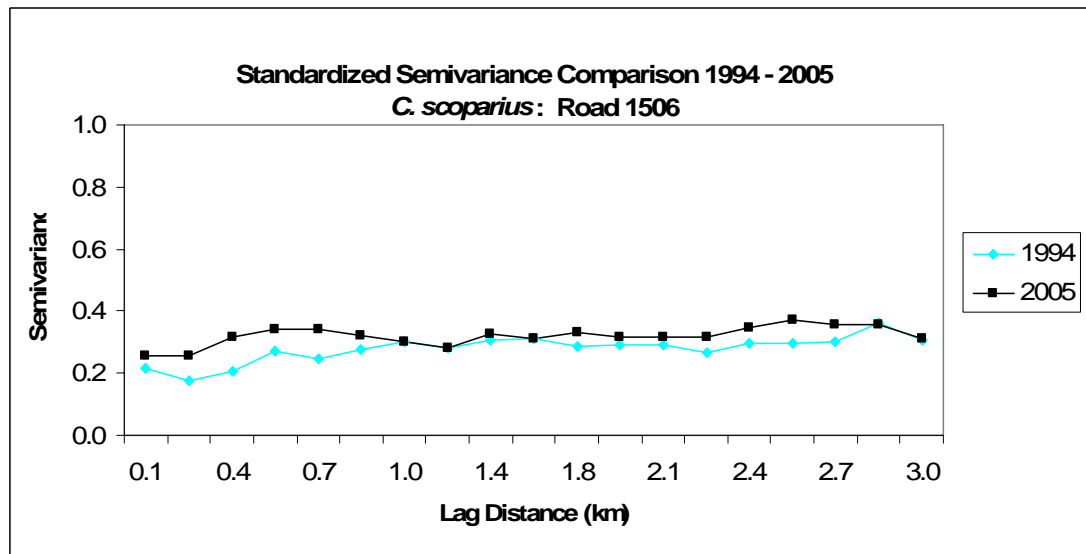

Figure 44. Standardized semivariance comparison from 1994 to 2005 for the presence of *C. scoparius* on road 1506.

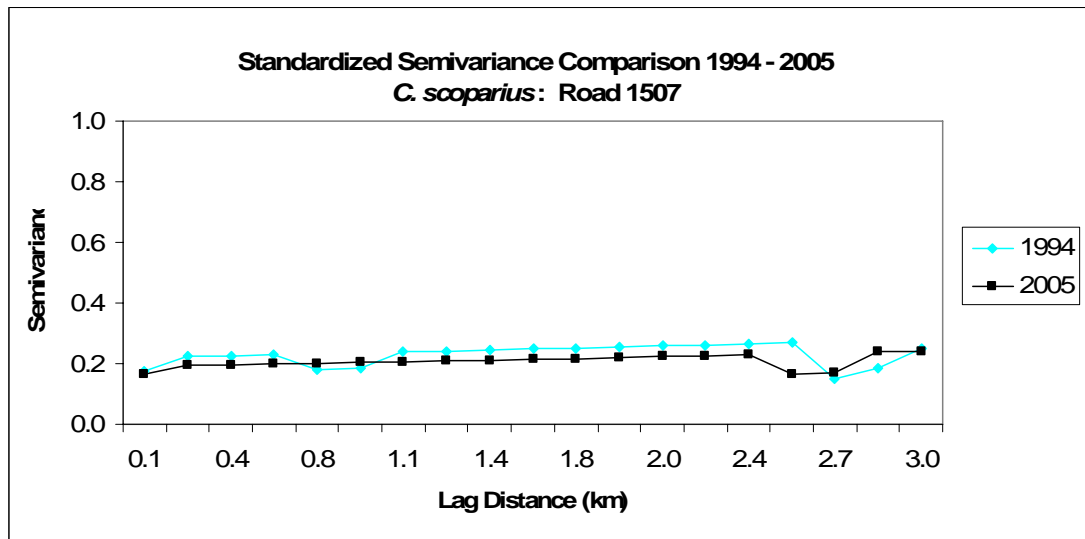

Figure 45. Standardized semivariance comparison from 1994 to 2005 for the presence of *C. scoparius* on road 1507.

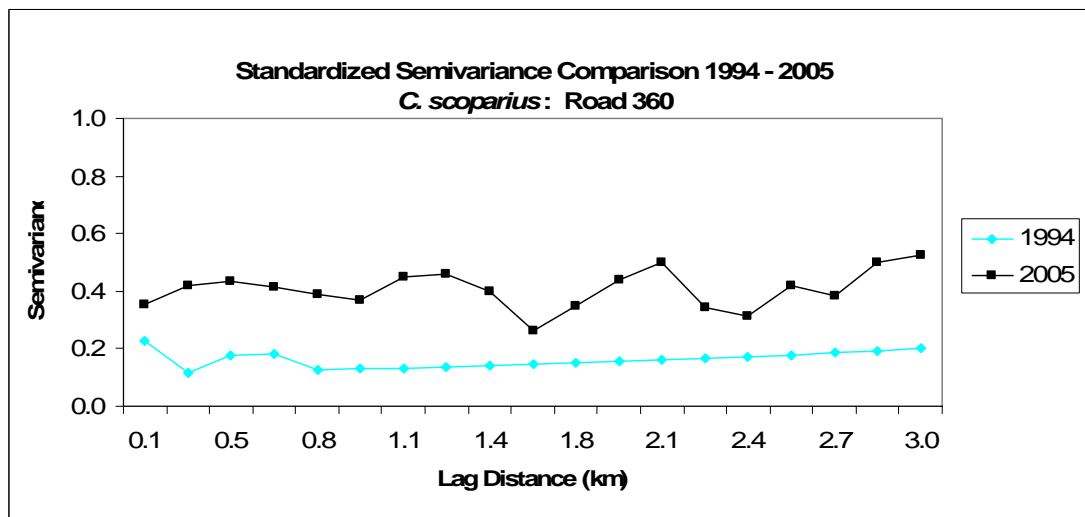

Figure 46. Standardized semivariance comparison from 1994 to 2005 for the presence of *C. scoparius* on road 360.

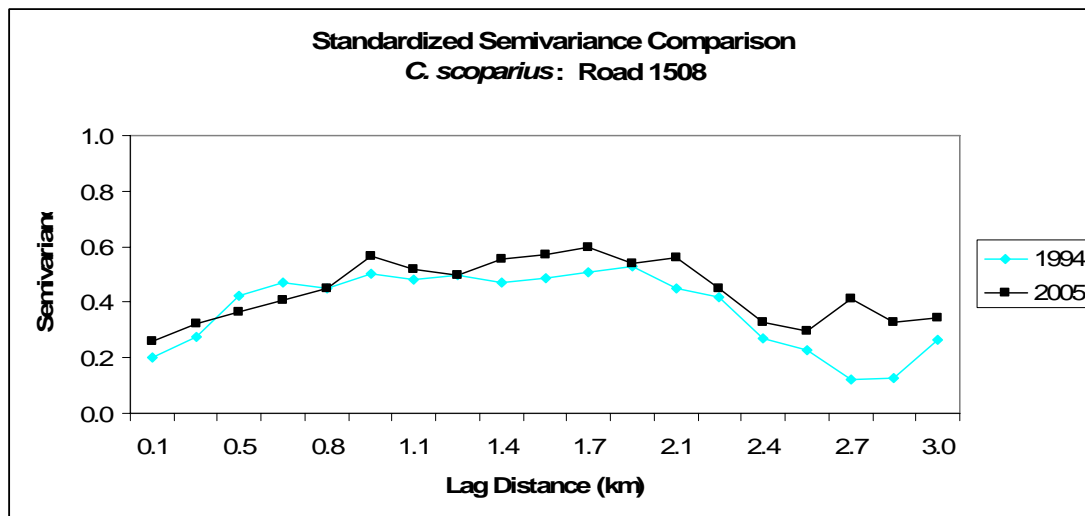

Figure 47. Standardized semivariance comparison from 1994 to 2005 for the presence of *C. scoparius* on road 1508.

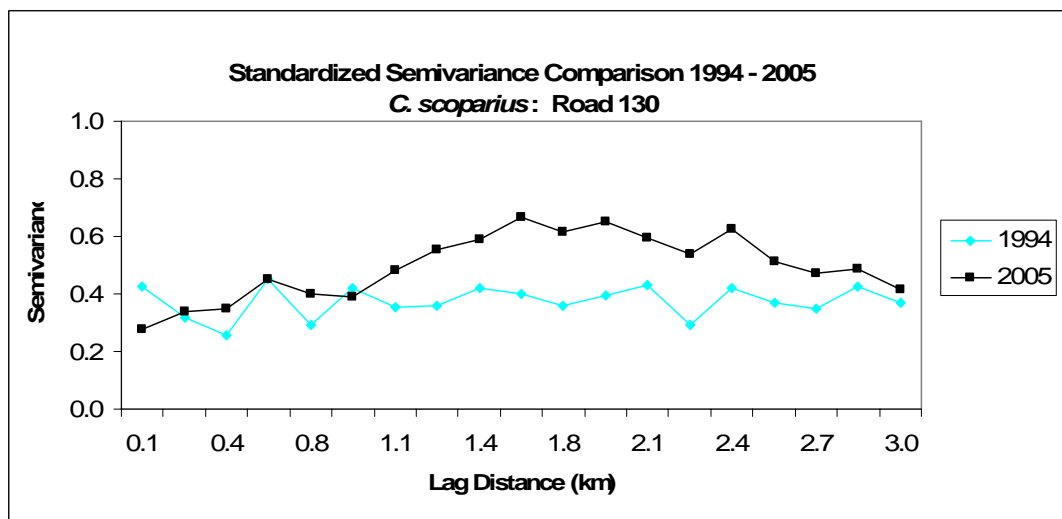

Figure 48. Standardized semivariance comparison from 1994 to 2005 for the presence of *C. scoparius* on road 130.

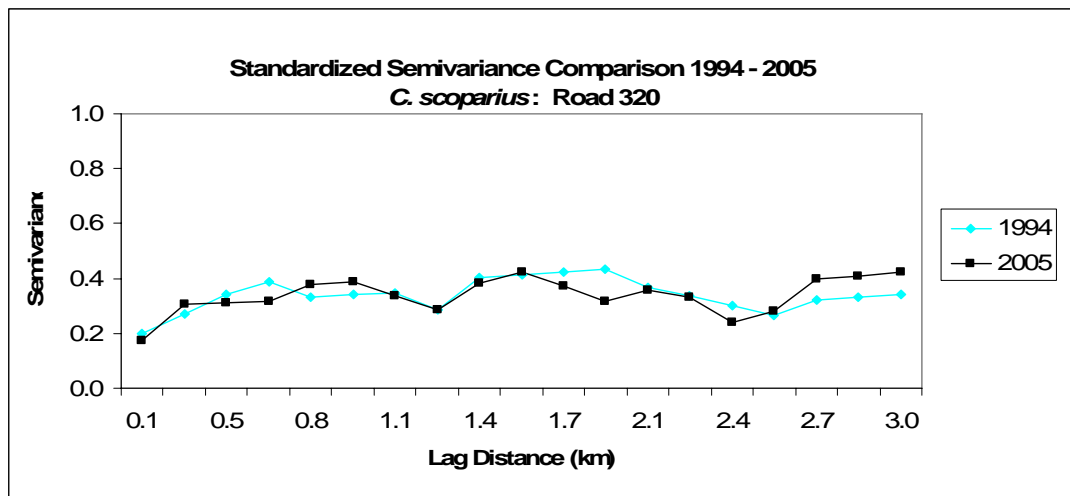

Figure 49. Standardized semivariance comparison from 1994 to 2005 for the presence of *C. scoparius* on road 320.

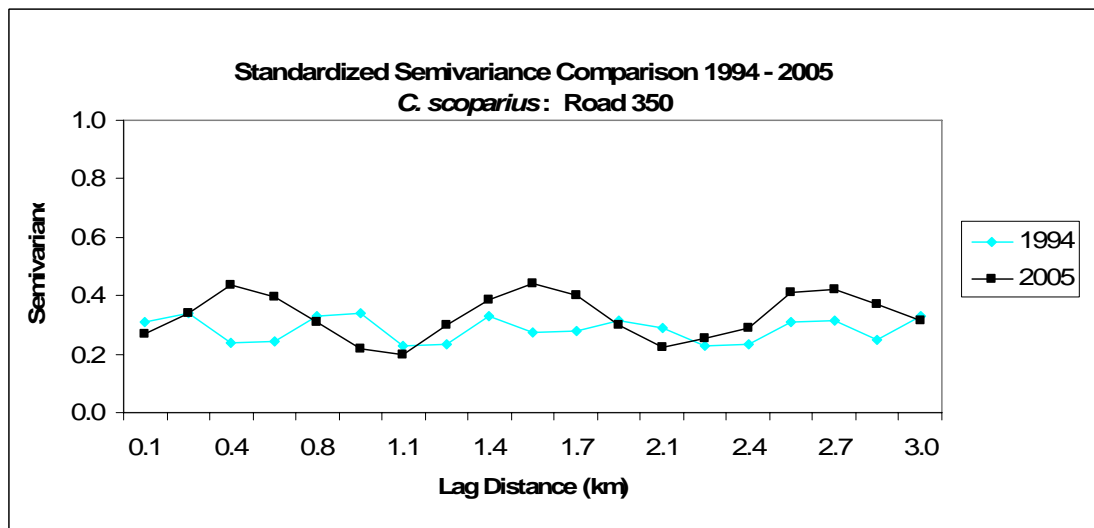

Figure 50. Standardized semivariance comparison from 1994 to 2005 for the presence of *C. scoparius* on Road 350.

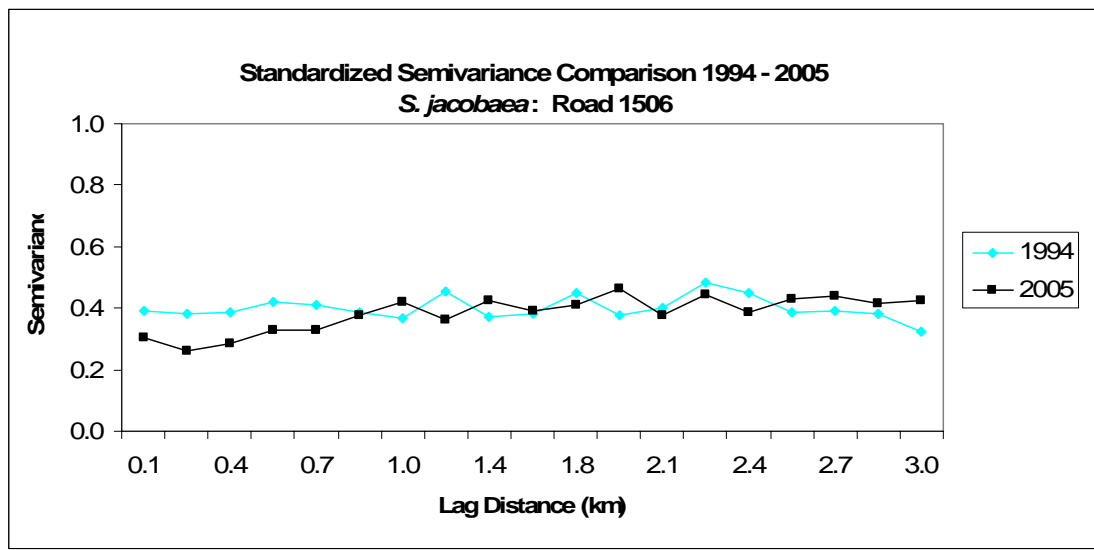

Figure 51. Standardized semivariance comparison from 1994 to 2005 for the presence of *S. jacobaea* on road 1506.

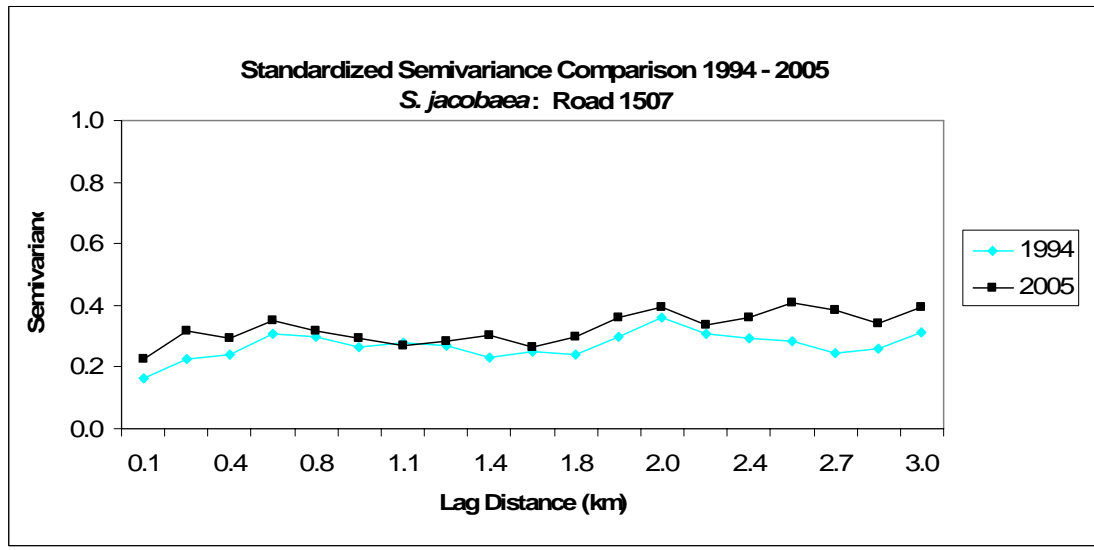

Figure 52. Standardized semivariance comparison from 1994 to 2005 for the presence of *S. jacobaea* on road 1507.

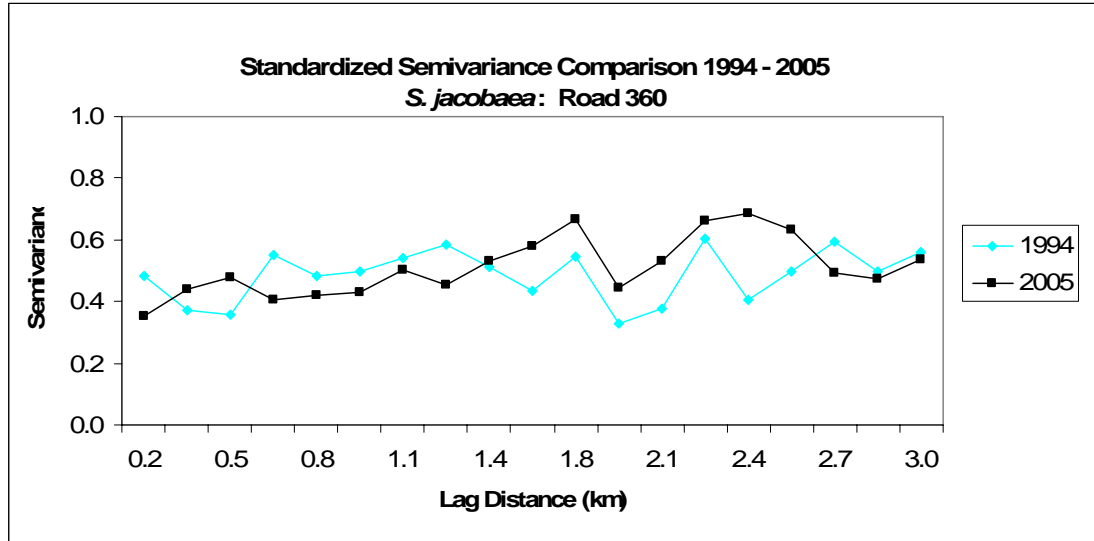

Figure 53. Standardized semivariance comparison from 1994 to 2005 for the presence of *S. jacobaea* on road 360.

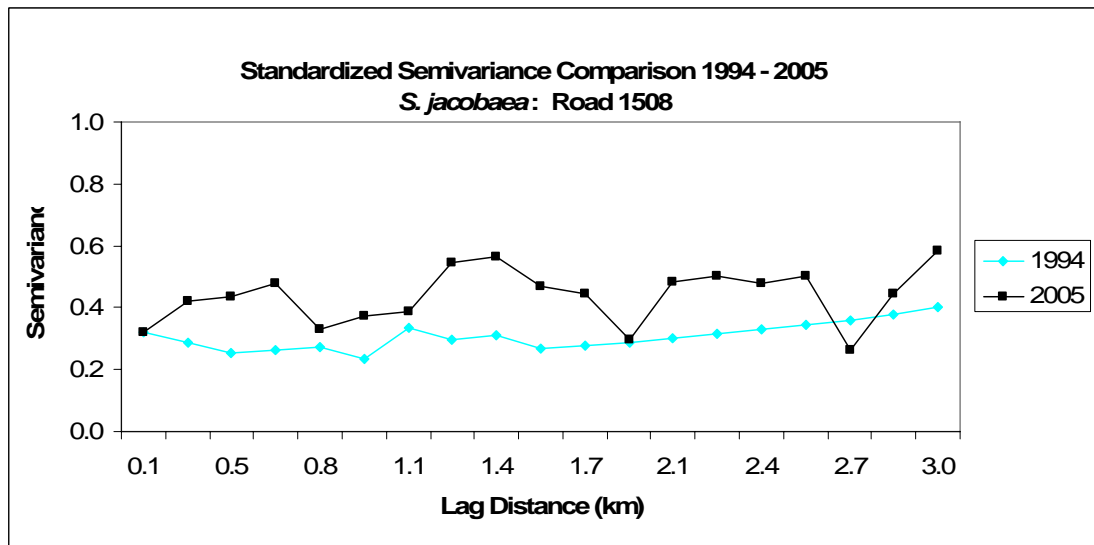

Figure 54. Standardized semivariance comparison from 1994 to 2005 for the presence of *S. jacobaea* on road 1508.

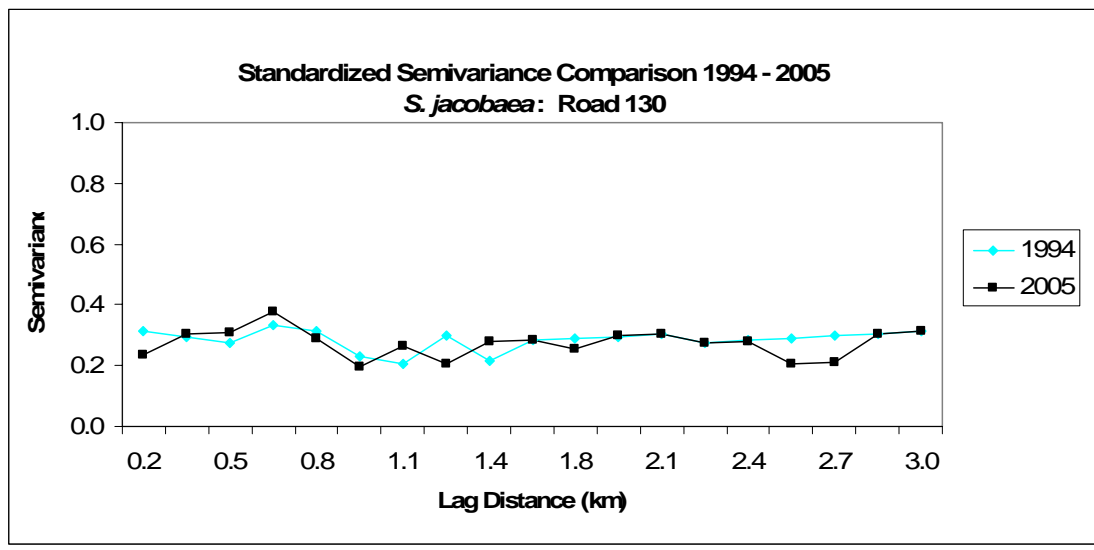

Figure 55. Standardized semivariance comparison from 1994 to 2005 for the presence of *S. jacobaea* on road 130.

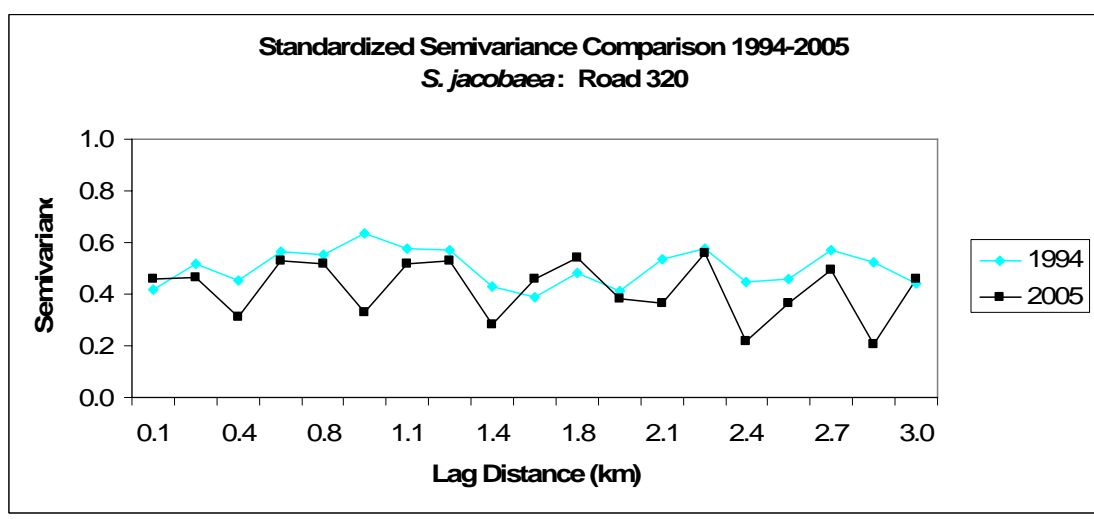

Figure 56. Standardized semivariance comparison from 1994 to 2005 for the presence of *S. jacobaea* on road 320.

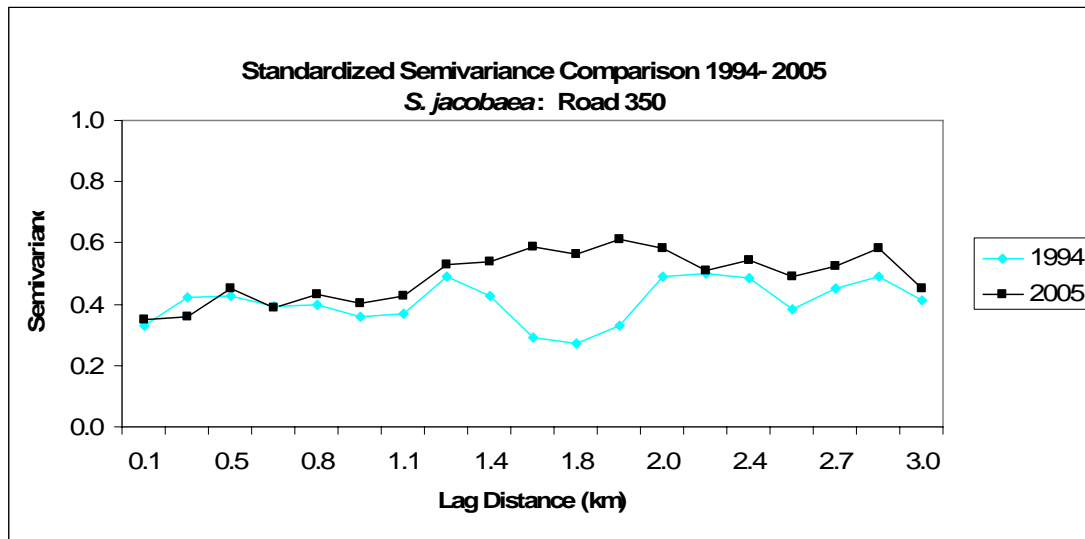

Figure 57. Standardized semivariance comparison from 1994 to 2005 for the presence of *S. jacobaea* on road 350.

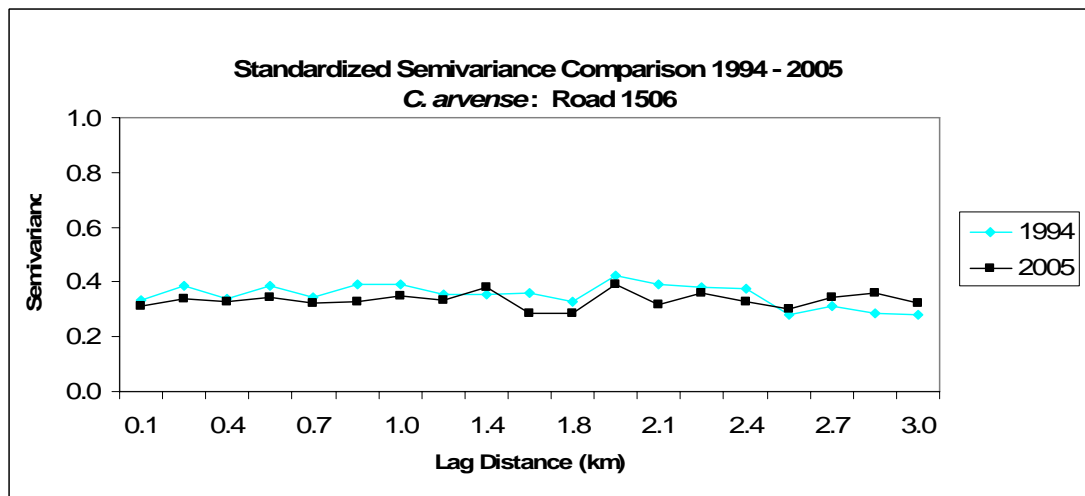

Figure 58. Standardized semivariance comparison from 1994 to 2005 for the presence of *C. arvensis* on road 1506.

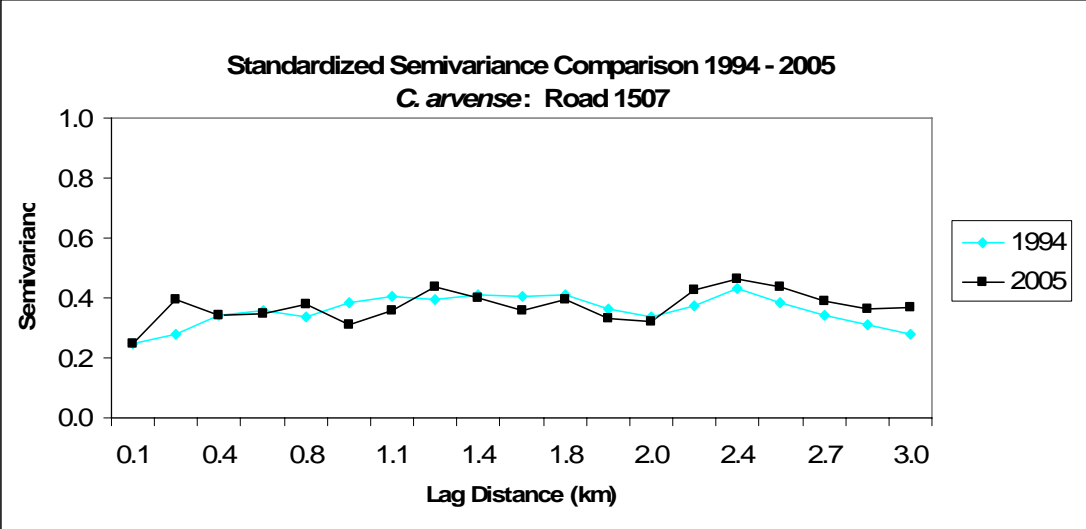

Figure 59. Standardized semivariance comparison from 1994 to 2005 for the presence of *C. arvense* on road 1507.

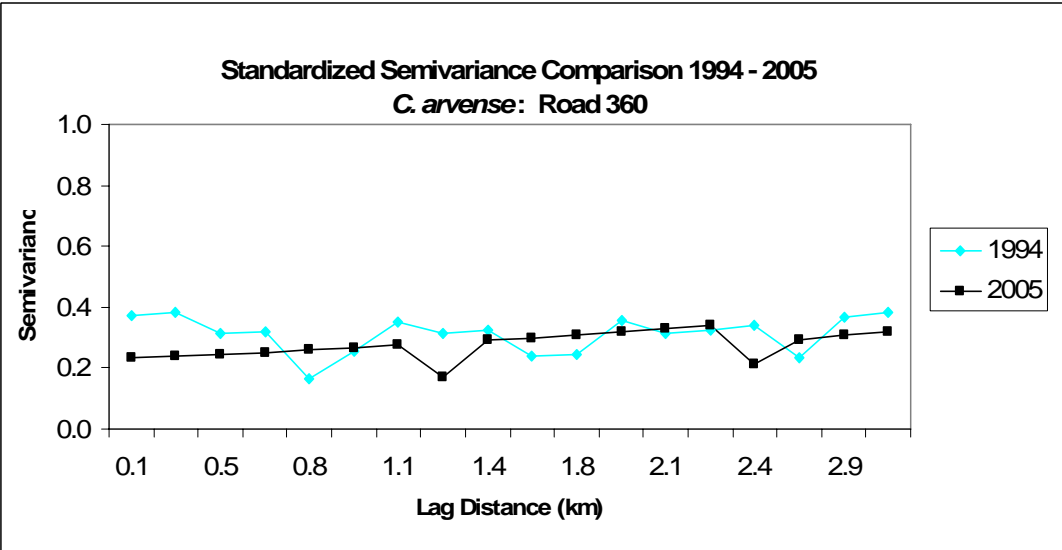

Figure 60. Standardized semivariance comparison from 1994 to 2005 for the presence of *C. arvense* on road 360.

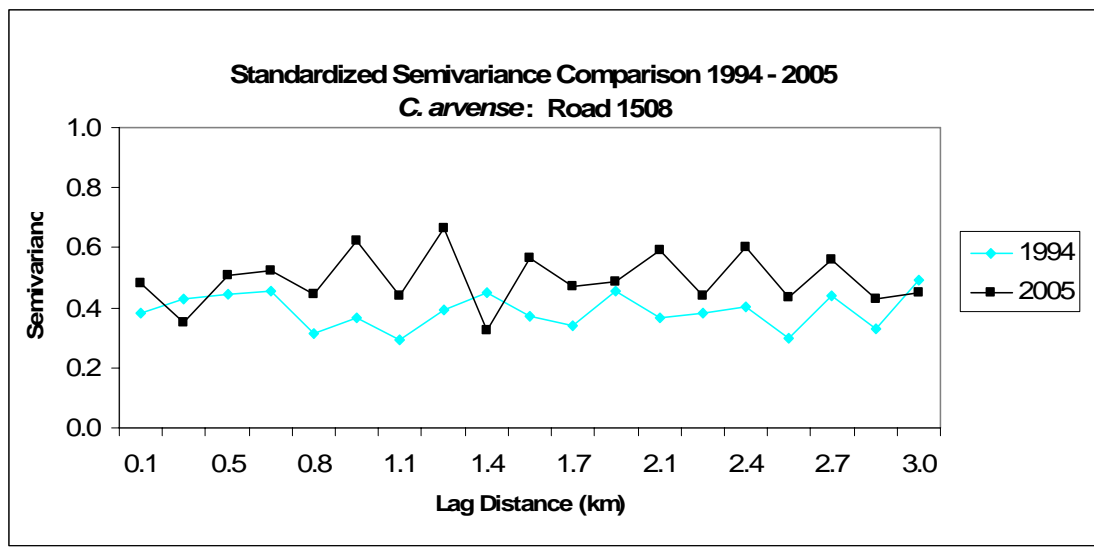

Figure 61. Standardized semivariance comparison from 1994 to 2005 for the presence of *C. arvense* on road 1508.

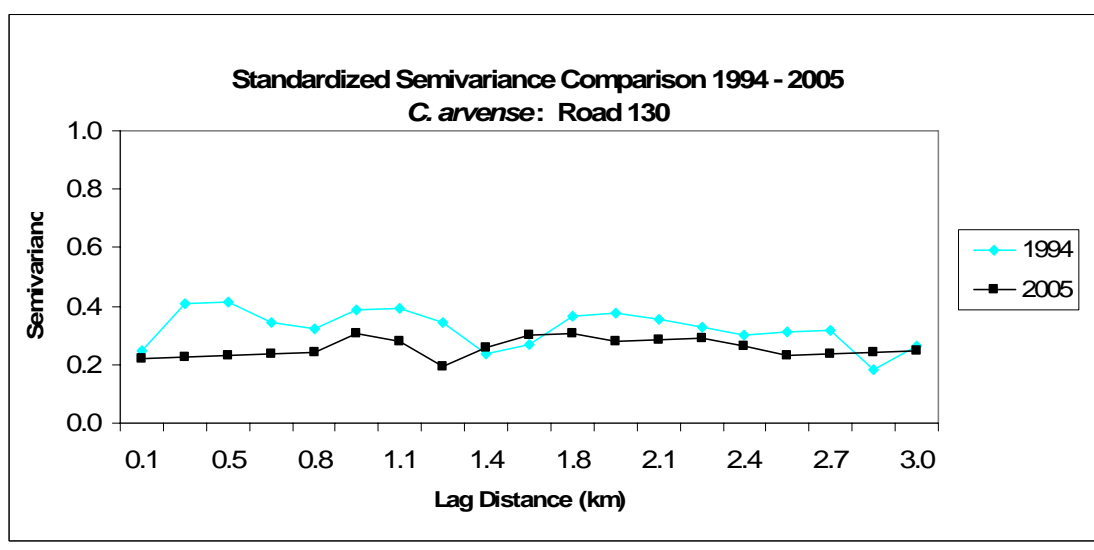

Figure 62. Standardized semivariance comparison from 1994 to 2005 for the presence of *C. arvense* on road 130.

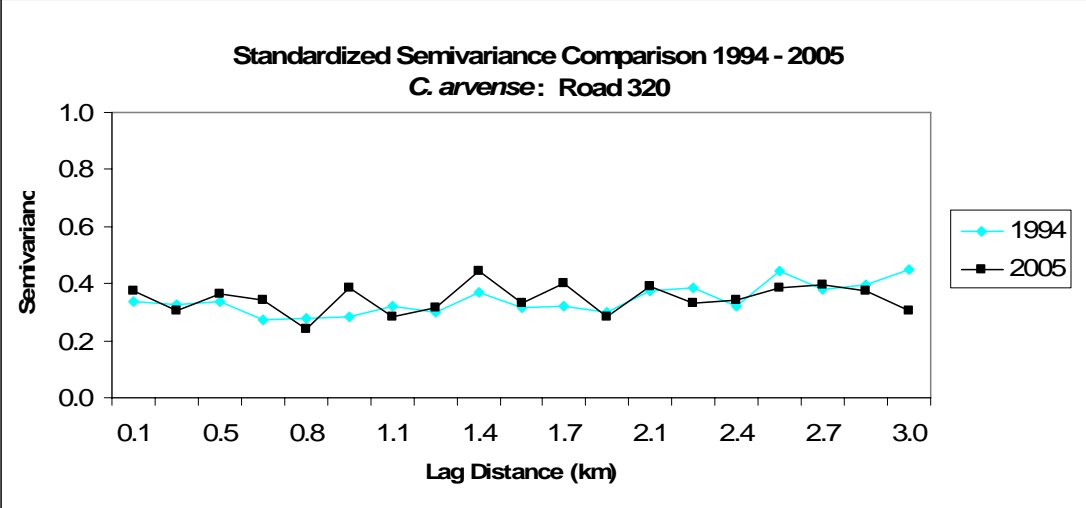

Figure 63. Standardized semivariance comparison from 1994 to 2005 for the presence of *C. arvense* on road 320.

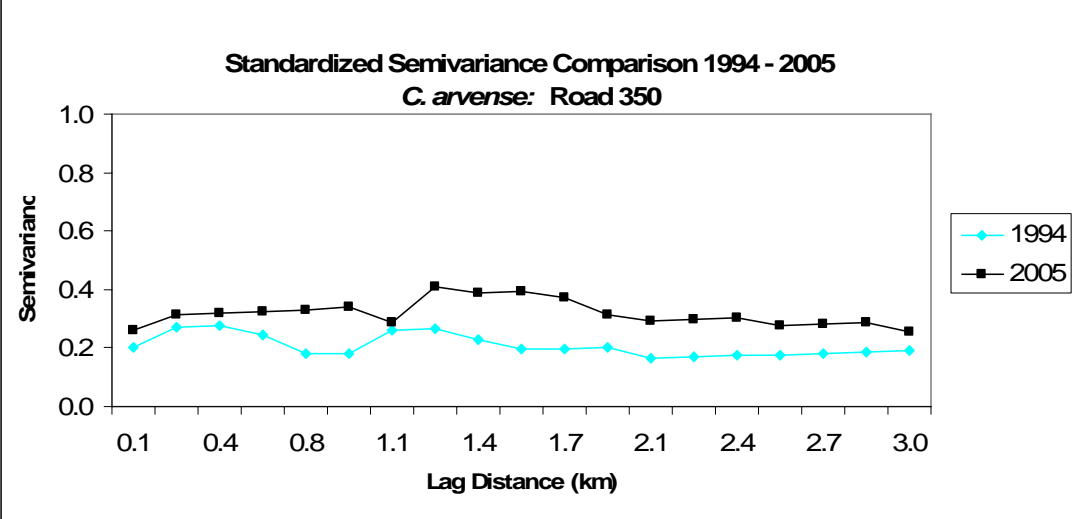

Figure 64. Standardized semivariance comparison from 1994 to 2005 for the presence of *C. arvense* on Road 1507.

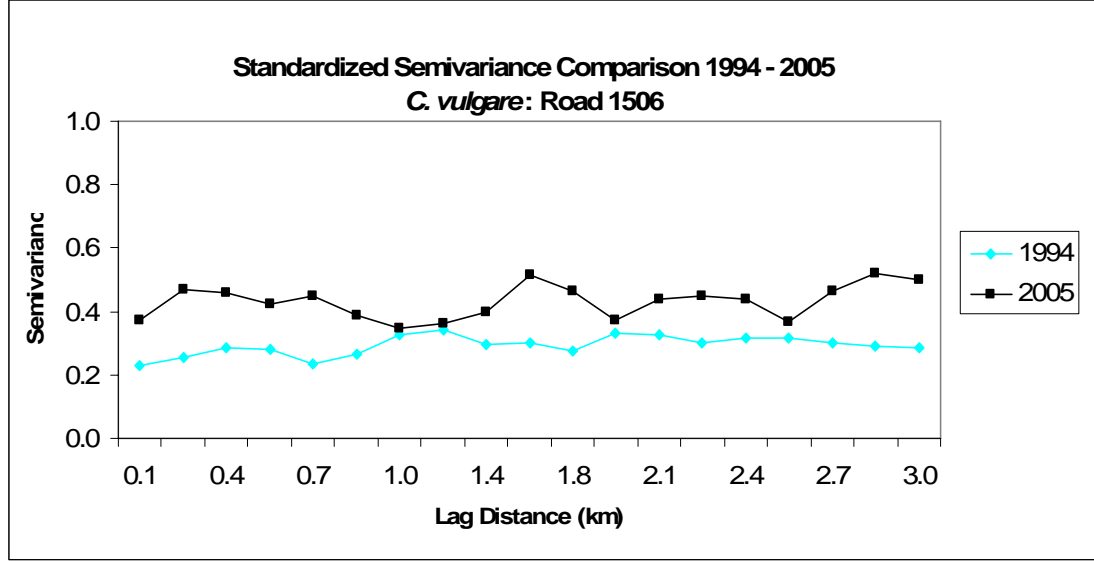

Figure 65. Standardized semivariance comparison from 1994 to 2005 for the presence of *C. vulgare* on road 1506.

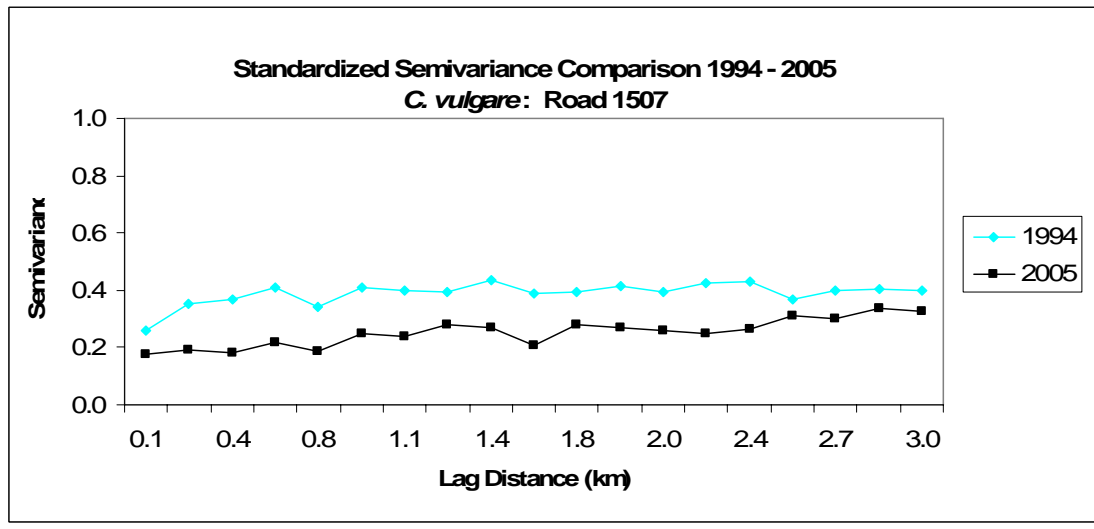

Figure 66. Standardized semivariance comparison from 1994 to 2005 for the presence of *C. vulgare* on road 1507.

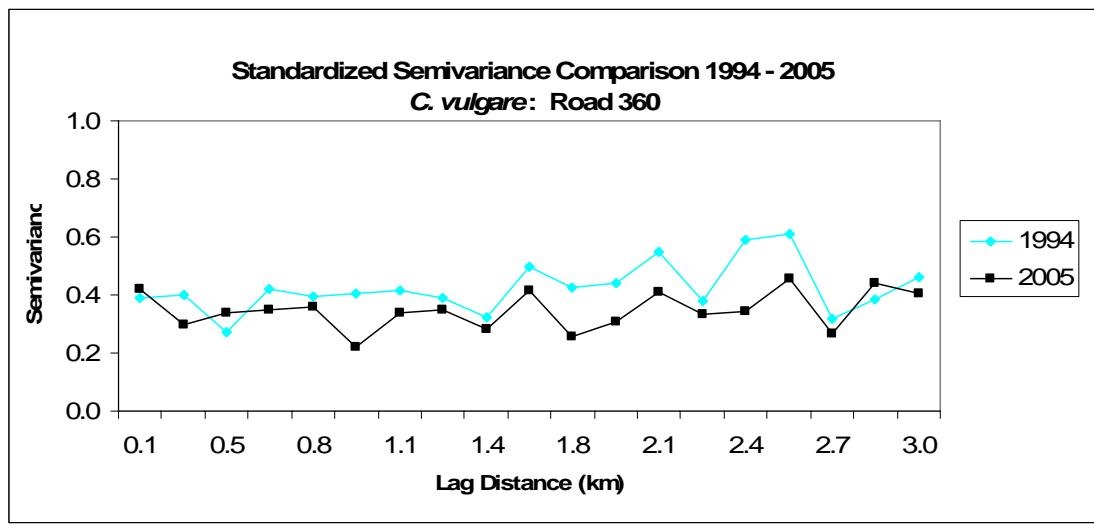

Figure 67. Standardized semivariance comparison from 1994 to 2005 for the presence of *C. vulgare* on road 360.

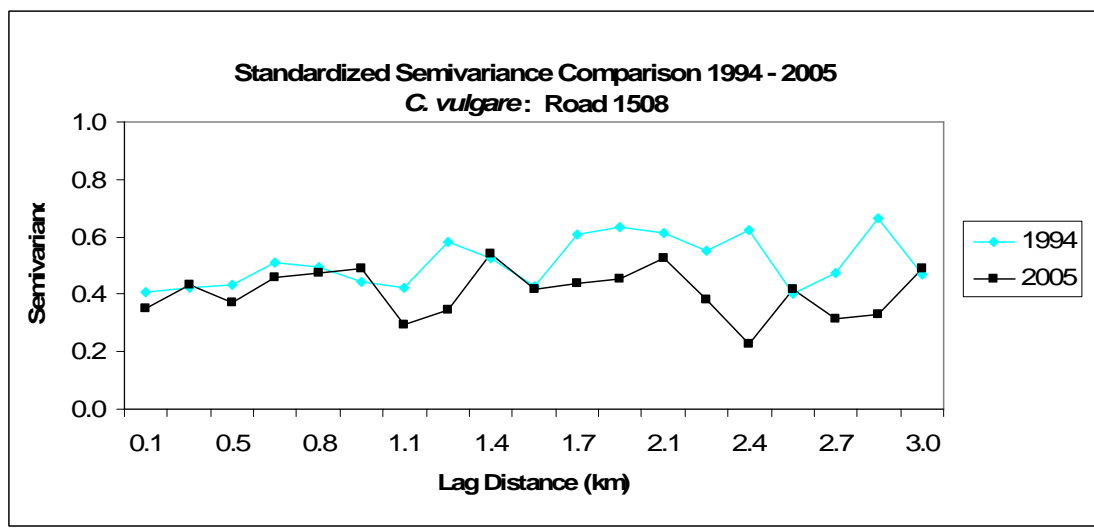

Figure 68. Standardized semivariance comparison from 1994 to 2005 for the presence of *C. vulgare* on road 1508.

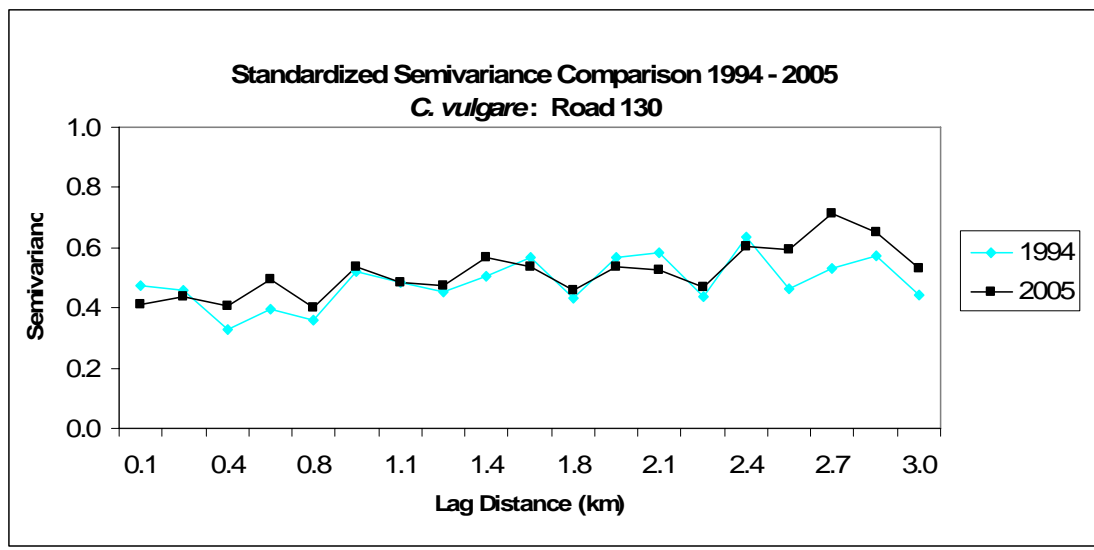

Figure 69. Standardized semivariance comparison from 1994 to 2005 for the presence of *C. vulgare* on road 130.

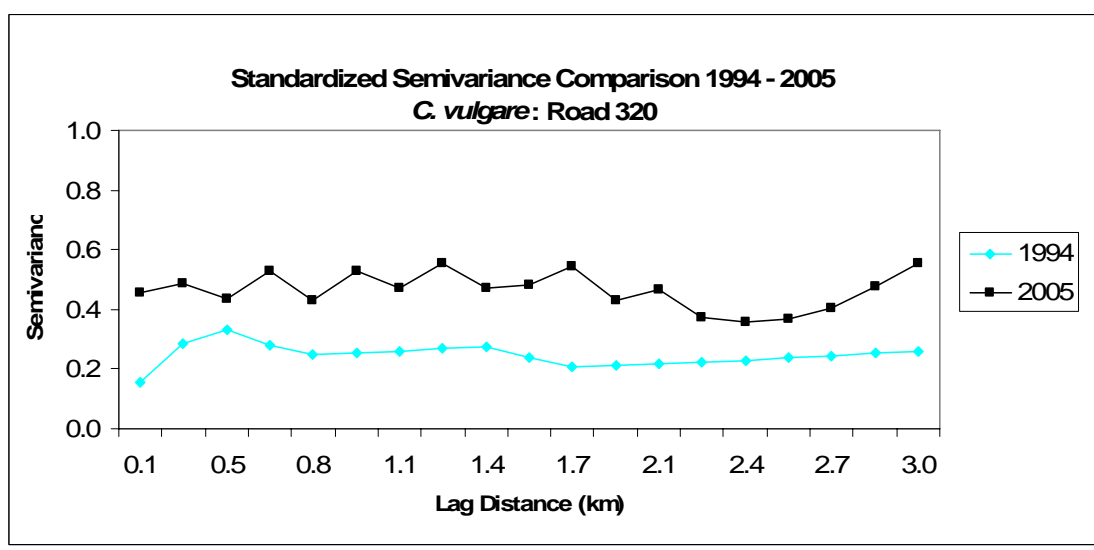

Figure 70. Standardized semivariance comparison from 1994 to 2005 for the presence of *C. vulgare* on road 320.

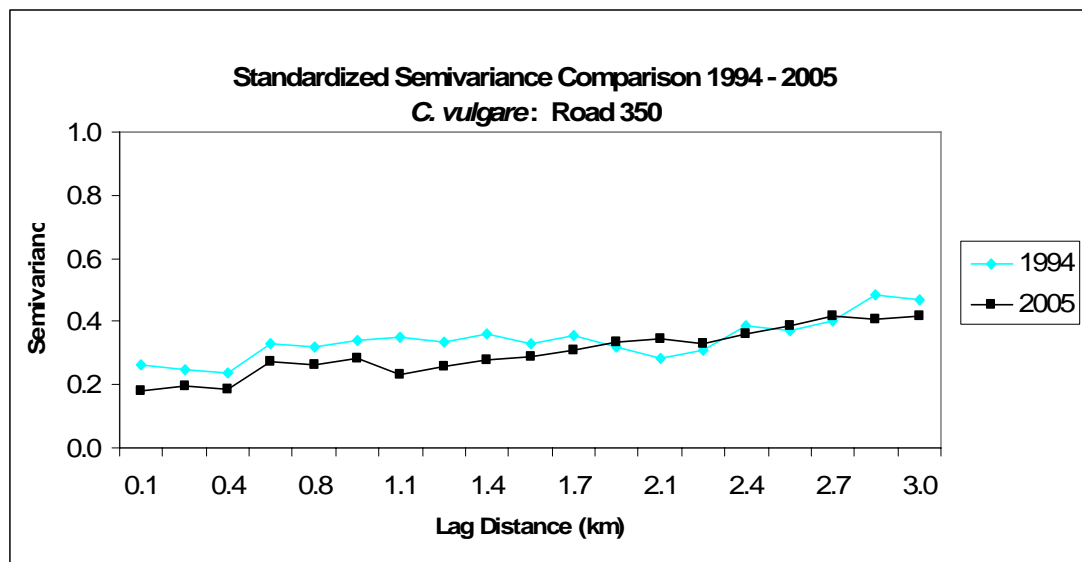

Figure 71. Standardized semivariance comparison from 1994 to 2005 for the presence of *C. vulgare* on road 350

In order to generalize spatial pattern changes on the network, a pattern topology key was created, which depicts eight possible changes in the sill and the gradient from 1994 to 2005 on the standardized semivariograms (Table 7). Spatial distribution of patches was considered random if the semivariogram was flat, and organized as a gradient if the semivariance increased with increasing lag distance. Included in the key is also a conceptual figure of the change in the standardized semivariogram and the corresponding change in patch size/arrangement on the network, as well as a narrative description which qualitatively describes the change. Each possible pattern change was assigned a “type” phrase, which is used in an attempt to generalize pattern change across different species on different roads. Species pattern changes by road were then summarized to analyze spatial pattern across species and across roads (Table 8).

Table 7. Standardized semivariogram key used in pattern change analysis.

Type	1994 Pattern	2005 Pattern	Change in Sill	Change in Gradient	Interpretation
Unchanging Random Pattern	<p>Random 1994</p>	<p>Random 2005</p>	None	None	Patches are randomly distributed on the network; no change in contrast of patch size from 1994 to 2005
Unchanging Gradient Pattern	<p>Gradient 1994</p>	<p>Gradient 2005</p>	None	None	Large patches grading to small on the network; no change in contrast of patch size from 1994 to 2005
Creation of a Gradient	<p>Random 1994</p>	<p>Gradient 2005</p>	None	Positive	Randomly distributed patches of various sizes from 1994 either (1) enlarged or (2) decreased in size at one end of a road in 2005
Loss of a Gradient	<p>Gradient 1994</p>	<p>Random 2005</p>	None	Negative	Patches that were large at one end of the road and small at the other in 1994 changed to random distribution of sizes in 2005
(1) Fragmentation of Large Patches or (2) Gain of Small Patches	<p>Random 1994</p>	<p>Random 2005</p>	Positive	None	Randomly distributed patches with low contrast in 1994 became patches with higher contrast in 2005

Table 7 continued. Standardized semivariogram key used in pattern change analysis.

Type	1994 Pattern	2005 Pattern	Change in Sill	Change in Gradient	Interpretation
(1) Small Patches Unite to Larger Patch or (2) Loss of Small Patches			Negative	None	Randomly distributed patches with higher contrast in 1994 became patches with lower contrast in 2005
Increase in Gradient			None	Positive	Patches that were large at one end of the road and small at the other in 1994 became larger or smaller at that end
Decrease in Gradient			None	Negative	Patches that were large at one end of the road and small at the other in 1994 became smaller or larger at that end

Table 8. Summary of spatial pattern changes by species and road from 1994 to 2005.

Road #	1506	1507	360	1508	130	320	350
Location	Valley	South Side	South Side	North Side	North Side	North Side	North Side
Species							
<i>H. perforatum</i>	Small Patches Unite into Larger Patch	Small Patches Unite into Larger Patch	-	-	-	-	Small Patches Unite into Larger Patch
<i>C. leucanthemum</i>	Small Patches Unite into Larger Patch	Small Patches Unite into Larger Patch	-	-	Unchanging Random Pattern	-	Loss of Gradient
<i>C. vulgare</i>	Fragmentation of Large Patches	Loss/Decrease in Size of Small Patches	Small Patches Unite into Larger Patch	Small Patches Unite into Larger Patch	Unchanging Random Pattern	Fragmentation of Large Patches	Loss/Decrease in Size of Small Patches
<i>S. jacobaea</i>	Unchanging Random Pattern	Gain/Growth of Small Patches	Unchanging Random Pattern	Gain/Growth of Small Patches	Unchanging Random Pattern	Loss/Decrease in Size of Small Patches	Gain/Growth of Small Patches
<i>C. scoparius</i>	Gain/Growth of Small Patches	Unchanging Random Pattern	Gain/Growth of Small Patches	Unchanging Gradient Pattern	Creation of a Gradient	Unchanging Random Pattern	Gain/Growth of Small Patches
<i>C. arvense</i>	Unchanging Random Pattern	Unchanging Random Pattern	Unchanging Random Pattern	Gain/Growth of Small Patches	Loss/Decrease in Size of Small Patches	Unchanging Random Pattern	Gain/Growth of Small Patches

Ten possible pattern changes are defined (Table 6). An “unchanging random pattern” indicates that patches are randomly distributed on the road in both 1994 and 2005, and the contrast of patch size, or the ratio of gaps to patches, has not changed over time. An “unchanging gradient pattern” indicates that patches were arrayed in a spatial gradient from large to small patches or from small to large patches on the road in both 1994 and 2005, and patch size has not changed over time. The “creation of a gradient” indicates a positive change in the slope of the sill, and that patches of various sizes randomly distributed in 1994 either enlarged in size at the end of a road, or decreased in size at the end of a road, creating a spatial gradient in 2005. The “loss of a gradient” indicates a negative change in the slope of the sill, as patches which were large at one end of the road and small at the other in 1994 have changed in size such that patches are randomly distributed in 2005. “Creation of a gradient” or “loss of a gradient” pattern changes do not indicate a change in ratio of gaps to patches, so the contrast of patch size is the same in 1994 and 2005, although the arrangement of patches is different.

A higher gap/patch ratio indicates an increase in the semivariance in 2005, or an increase in the ratio of patches to gaps on roads where patches and gaps are randomly distributed in both years. This could be a function of two pattern changes: (1) “fragmentation of large patches”, where on roads with a few continuously distributed patches in 1994, patches decrease in size to form many randomly distributed gaps in 2005, or (2) “gain/growth of small patches”, where on roads with a few randomly distributed patches in 1994, patches either grew in size, or become established in new areas in 2005. A lower gap/patch ratio indicates a decrease in the

semivariance in 2005, or a decrease in gap/patch ratio on roads where patches and gaps are randomly distributed in both years. This could be a function of two pattern changes: (1) “smaller patches unite into a larger patch”, where on roads with a few randomly distributed patches in 1994, patches grew together and formed larger sized patches in 2005, or (2) “loss/decrease in size of small patches”, where on roads with randomly distributed patches in 1994, patches disappeared or decreased in size in 2005.

An “increase in gradient” indicates a positive change in the slope of the sill, and that the spatial gradient pattern has become stronger from 1994 to 2005. This would indicate that patches that were large at one end of the road and small at the other in 1994 became larger at one end and smaller at the other end in 2005, strengthening the gradient of small to large or large to small patches from 1994 to 2005. A “decrease in gradient” indicates a negative change in the slope of the sill, and that the spatial gradient pattern has weakened from 1994 to 2005. This would indicate that patches that were large at one end of the road in 1994 became smaller, and patches that were small at the other end in 1994 became larger, weakening the gradient of small to large patches or large to small patches in 2005.

Species demonstrated variable pattern changes from 1994 to 2005 on the different roads analyzed, but some general trends are evident in the data (Table 7). The 14.7% net increase of *C. leucanthemum* on the road network is a function of remotely distributed patches from 1994 on roads 1506 and 1507 joining together to form long, continuous segments in 2005 (Figure 29), resulting in the “small patches unite into larger patches” pattern change on these roads. On road 350, *C.*

leucanthemum similarly filled in previous discontinuous patches to form continuous segments, resulting in the loss of a gradient pattern evident in 1994. On road 130, patches of *C. leucanthemum* were randomly distributed and did not change pattern from 1994 to 2005.

C. scoparius and *S. jacobaea* also demonstrated net increases on the road network (6.0%, and 3.4%, respectively) (Table 5). On roads 1506, 360, and 350, discontinuously distributed patches of *C. scoparius* from 1994 increased in size, and some new patches were established in 2005 (Figure 32), resulting in the “gain/growth of small patches” pattern change on these roads. On road 130, the expansion of patches from 1994 at the end of the road caused a gradient pattern of *C. scoparius* to be created in 2005. On roads 1507 and 320, patches of *C. scoparius* were randomly distributed, and on road 1508, patches were distributed in a gradient, but arrangement and size of *C. scoparius* patches on these roads and did not change from 1994 to 2005 (Table 7).

S. jacobaea increased as the result of similar changes in spatial distribution, but on different roads. Patches of *S. jacobaea* from 1994 expanded in size on roads 1507 and 350, and new patches were established on road 1508 (Figure 33), resulting in the “gain/growth of small patches” pattern on these roads in 2005. Discontinuously distributed patches of *S. jacobaea* from 1994 disappeared in 2005 on road 320, resulting in a “loss/decrease in size of small patches” pattern change on this road. On roads 1506, 360, and 130, patches of *S. jacobaea* were randomly distributed and did not change pattern from 1994 to 2005 (Table 7).

H. perforatum's moderate increase of 5.8% is reflected in the "small patches unite into larger patches" pattern change on roads 1506, 1507, and 350 in 2005 (Table 7). On each of these roads in 1994, distribution was continuous from the base of roads at lower elevations up to the last 2-3 kilometers at the road end, where distribution was patchy (Figure 31). In 2005, these former gaps at the ends of the roads filled in to form nearly 100% continuous distribution from road start to end, resulting in a lower gap/patch ratio in 2005. Patch expansion on these roads, as well as on road 359 (too short to analyze spatial pattern), account for almost all of the increase in *H. perforatum* from 1994 to 2005, as other major roads of significant length, including 1508, 360, 320, and 130, already maintained over 95% frequency of *H. perforatum* in 1994 (Figure 31).

C. arvensis demonstrated a very small (1.2%) decrease on the roads sampled (Table 5). This decrease is evident on road 130, where large patches of *C. arvensis* from 1994 disappeared in 2005 (Figure 35), resulting in a "loss/decrease in size of small patches" pattern change on this road. This decrease in presence was balanced by increase on roads 1508 and 350, where new patches of *C. arvensis* were established in 2005, resulting in a "gain/growth of small patches" pattern change on these roads. On roads 1506, 1507, 360, and 320, patches were randomly distributed and did not change pattern from 1994 to 2005 (Table 7).

The significant net decrease (20%) of *C. vulgare* is also echoed in the changing spatial dynamics on the road network. Patches of *C. vulgare* from 1994 disappeared from the last 5 km of road 1507, and from the last 2 km of road 350 (Figure 36), resulting in a "loss/decrease in size of small patches" pattern change on these roads

(Table 7). On roads 360 and 1508, some gaps were formed in continuous segments from 1994, but change in spatial pattern was dominated by discontinuous patches from 1994 which united into longer, continuous segments in 2005, resulting in a “small patches uniting into larger patches” pattern change on these roads. Long, continuous segments of *C. vulgare* from 1994 were broken up by gap formation in 2005 on roads 320 and 1506, resulting in a “fragmentation of large patches” pattern change on these roads. On road 130, patches were randomly distributed and did not change pattern from 1994 to 2005 (Table 7).

There were few discernable trends in spatial pattern changes by road. For three out of five species sampled on road 130 (*C. leucanthemum*, *C. vulgare*, and *S. jacobaea*), the spatial pattern remained random and unchanged from 1994 to 2005. Three out of the four species that changed in spatial pattern from 1994 to 2005 on road 1507 demonstrated increase, as small patches united into larger patches for *C. leucanthemum* and *H. perforatum*, and *S. jacobaea* demonstrated a gain or growth of small patches.

All six species sampled in the analysis demonstrated spatial change on road 350, in a variety of ways. Patches of *H. perforatum* and *C. leucanthemum* from 1994 filled into more continuous segments in 2005 (Figures 31 and 29), patches of *C. vulgare* from 1994 disappeared in 2005 (Figure 36), patches of *S. jacobaea* from 1994 expanded in size in 2005 (Figure 33), new patches of *C. arvensis* were established in 2005 (Figure 35), and *C. scoparius* had both patch expansion, as well the establishment of new patches in 2005 on road 350 (Figure 32). The only three roads where a gradient is present (road 1508: *C. scoparius*), was lost (*C. leucanthemum*:

road 350), or was created (road 130: *C. scoparius*) are all located on the north side of the Lookout Creek Basin. No species on any road experienced an increase or a decrease in the strength of a gradient pattern from 1994 to 2005.

Relationship Between Exotic Species Presence and Landscape Factors

Four environmental variables of the H. J. Andrews Forest landscape (elevation, mean annual precipitation, aspect, and canopy cover) and four human disturbance factors (decade of creation of the adjacent clearcut, decade of road construction, level of road use, and proximity to environmental monitoring stations) were evaluated in conjunction with three different aspects of exotic plant distribution: presence/absence in 2005 of 11 species (*C. leucanthemum*, *H. performatum*, *C. vulgare*, *C. arvense*, *L. muralis*, *D. purpurea*, *C. scoparius*, *S. jacobaea*, *R. discolor*, *B. sylvaticum*, and *C. maculosa*), and the change from 1994 to 2005 of the first eight of these species which were sampled in both years.

Elevation

Elevation steadily increases from west to east at the H.J. Andrews, reaching heights greater than 1500 m at the far eastern ridge of the watershed, and between 1200 m and 1500 m at the eastern and southern boundaries (Figure 72). Elevation is lowest within and around the riparian area of Lookout Creek towards the southwest. No portion of the road network extends into elevations greater than 1500 m, and almost half (47%) of the network occurs between 600 and 900 m (Figure 73).

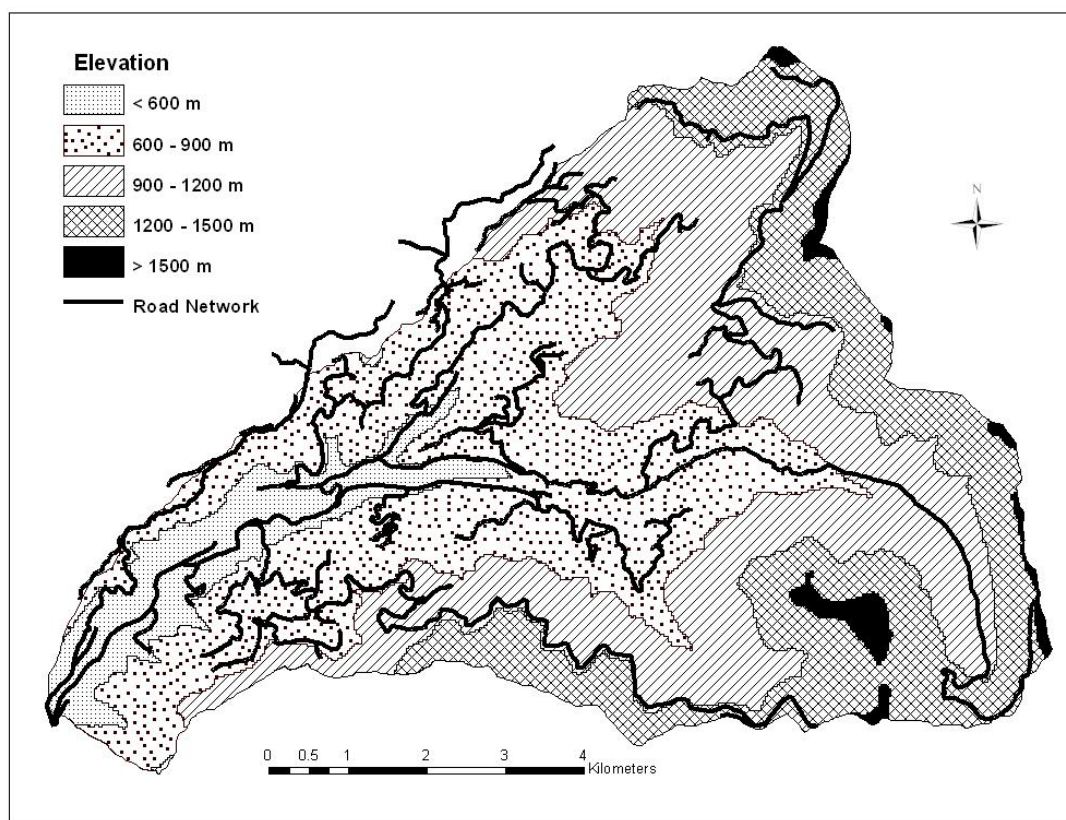

Figure 72. Landscape pattern of elevation at the H.J. Andrews Forest.

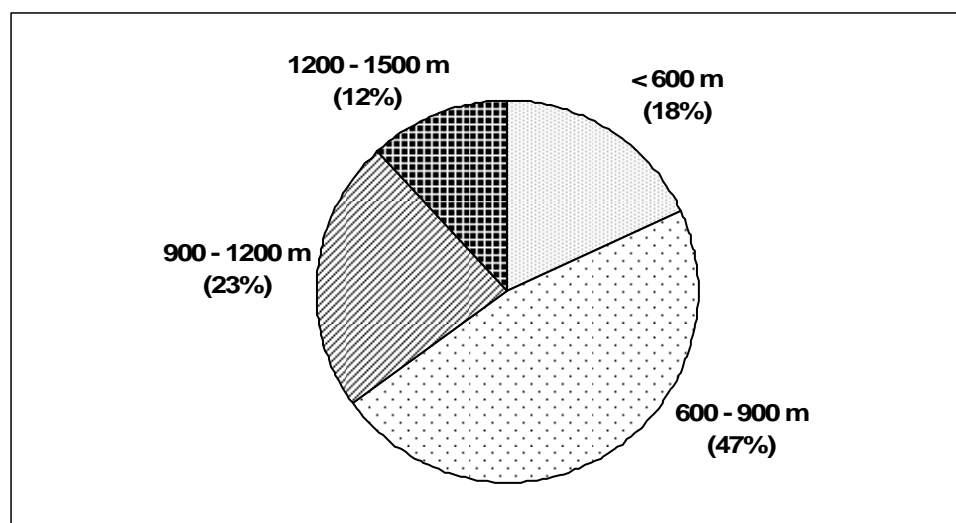

Figure 73. Percentage of road network within each elevation class.

Mean Annual Precipitation

Mean Annual precipitation ranges from < 2400 mm to > 3200 mm per year at the H. J. Andrews Forest, with lower amounts (< 2800 mm/year) occurring in the southwest and central portions of the basin, following a gradient to the highest levels occurring in the south and southeast area along Lookout Ridge (Figure 74). The majority of the road network (68%) exists in the lowest precipitation class (< 2400 mm), and only 2% exists in the highest precipitation class, where average annual rainfall tops 3200 mm/yr (Figure 75).

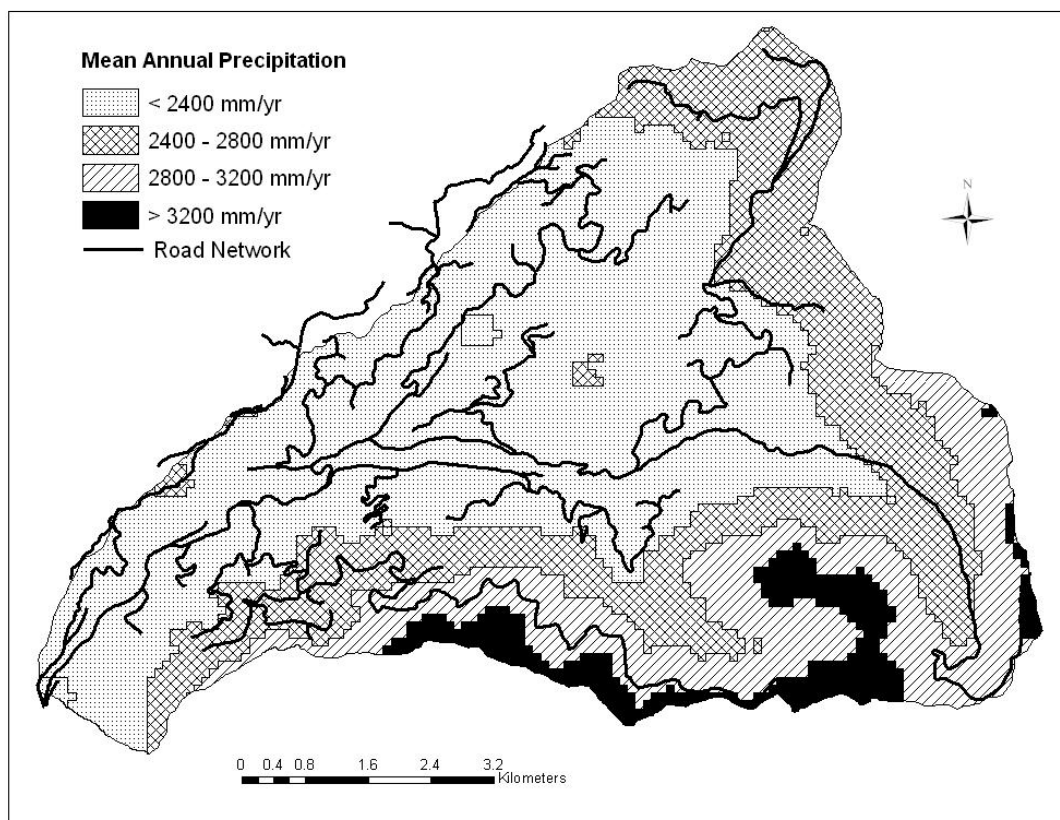

Figure 74. Landscape pattern of mean annual precipitation at the H. J. Andrews Forest.

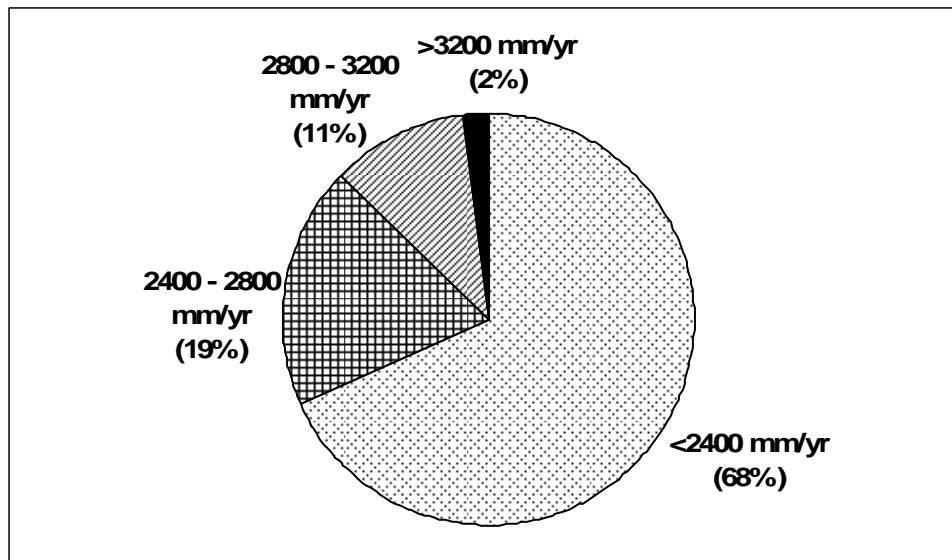

Figure 75. Percentage of road network within each precipitation class.

Aspect

Southern and western-facing slopes dominate the northern half of the H.J. Andrews Forest, whereas the southern half is dominated by a long north facing slope extending down from Lookout Ridge to Lookout Creek, intermixed with some eastern and western faces surrounding Lookout Mountain in the southeast corner (Figure 76). The road network is nearly evenly divided between western (29%), northern (29%) and southern (32%) facing slopes, while only 10% of roads traverse east facing slopes (Figure 77).

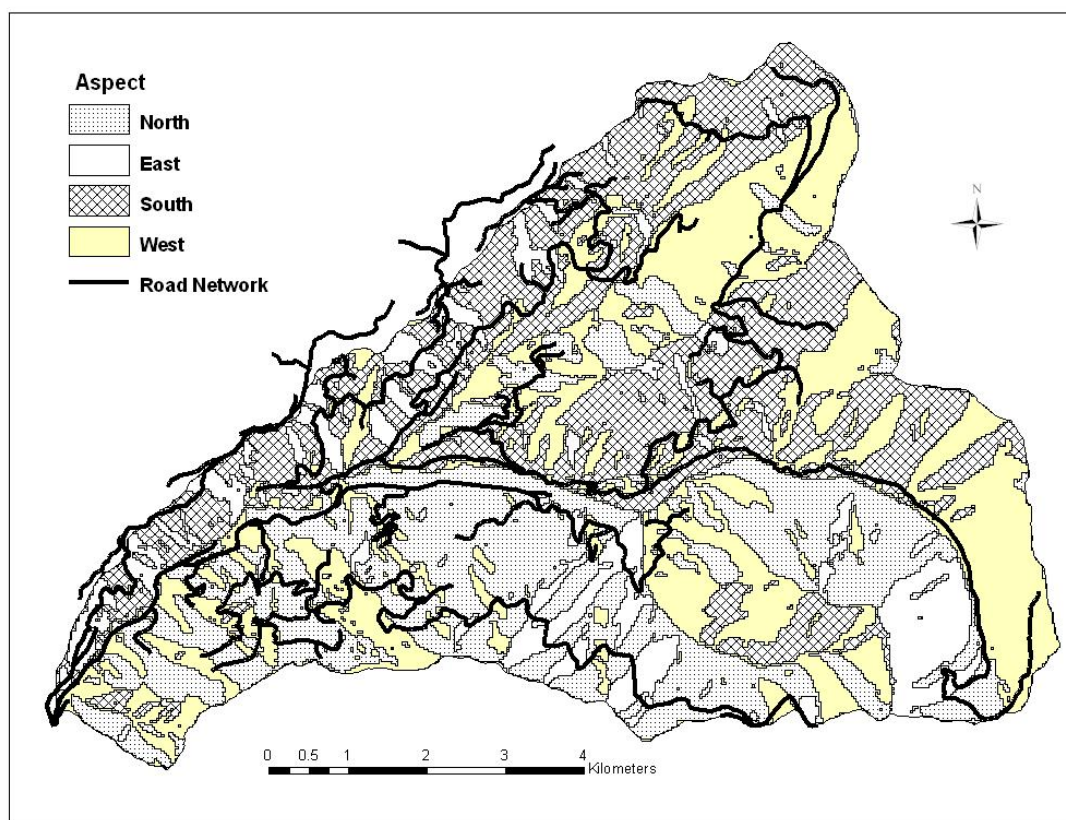

Figure 76. Landscape pattern of aspect at the H.J. Andrews Forest.

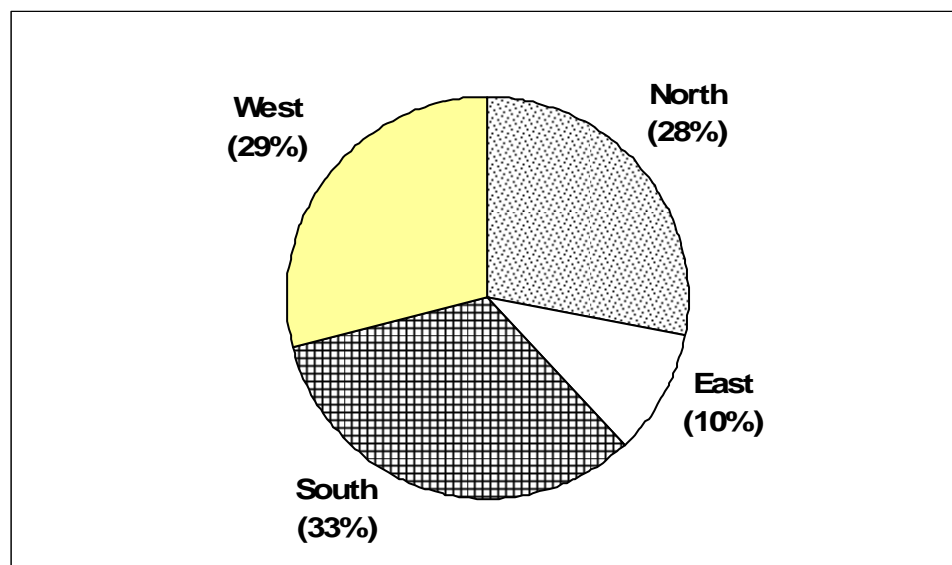

Figure 77. Percentage of road network within each aspect class.

Canopy Cover

Canopy cover was diverse on the road network, with a variation of cover on longer, major roads such as 1506, and a more consistent trend of high canopy cover on smaller side roads such as 365 and 330 (Figure 78). Roads that follow ridges, such as 1507, appear to have lower degrees of cover, while roads at lower elevations towards the watershed floor are more shaded. A majority of the road network (47%) was categorized as medium cover, while only 2% was estimated as very low, and only 5% as high (Figure 79).

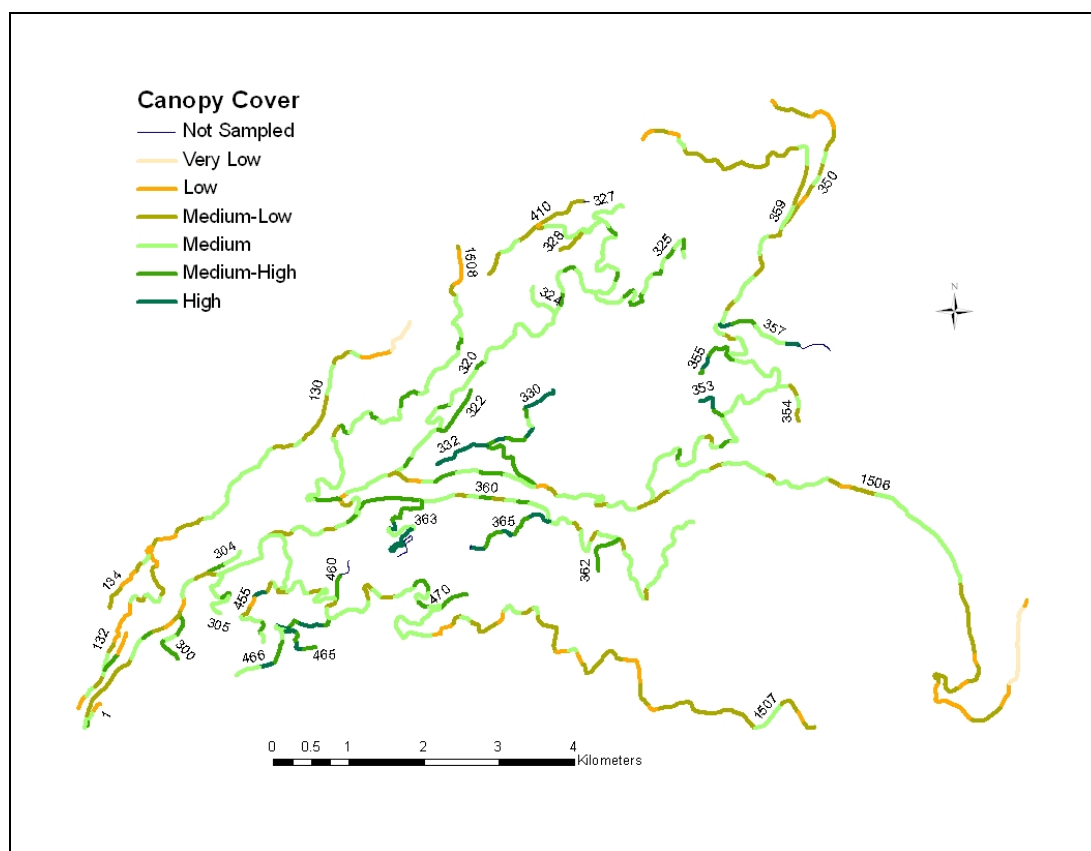

Figure 78. Distribution of canopy cover estimates on the H.J. Andrews Road Network.

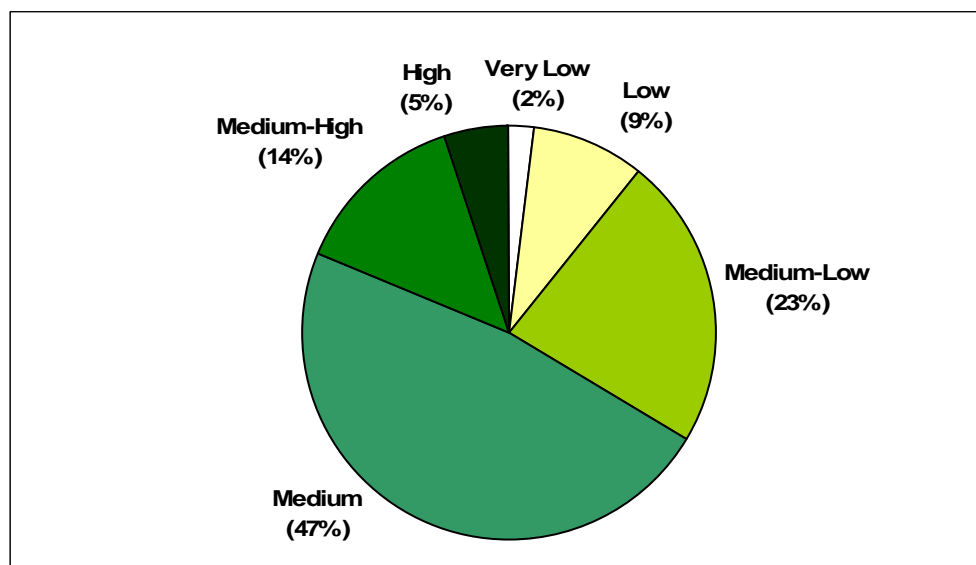

Figure 79. Percentage of road network within each canopy cover estimate class.

Age of Adjacent Clearcut Unit

A majority of the timber harvest activity at the H.J. Andrews took place between 1950 and 1969 (Figure 80). Cutting in the 1950's was focused in the center of the watershed along major roads, whereas in the 1960's harvesting extended to the periphery of the road network at higher elevations. Some additional, although fewer, patches were harvested in the 1970's and 1980's, while only two locales were clearcut between 1990 and 1999. Approximately 66% of the current road network is adjacent to a unit that has been clearcut, with almost half of the road network (45%) adjacent to an area harvested between 1950 and 1970 (Figure 81). Only 7% of the road network is adjacent to a unit that was clearcut after 1980.

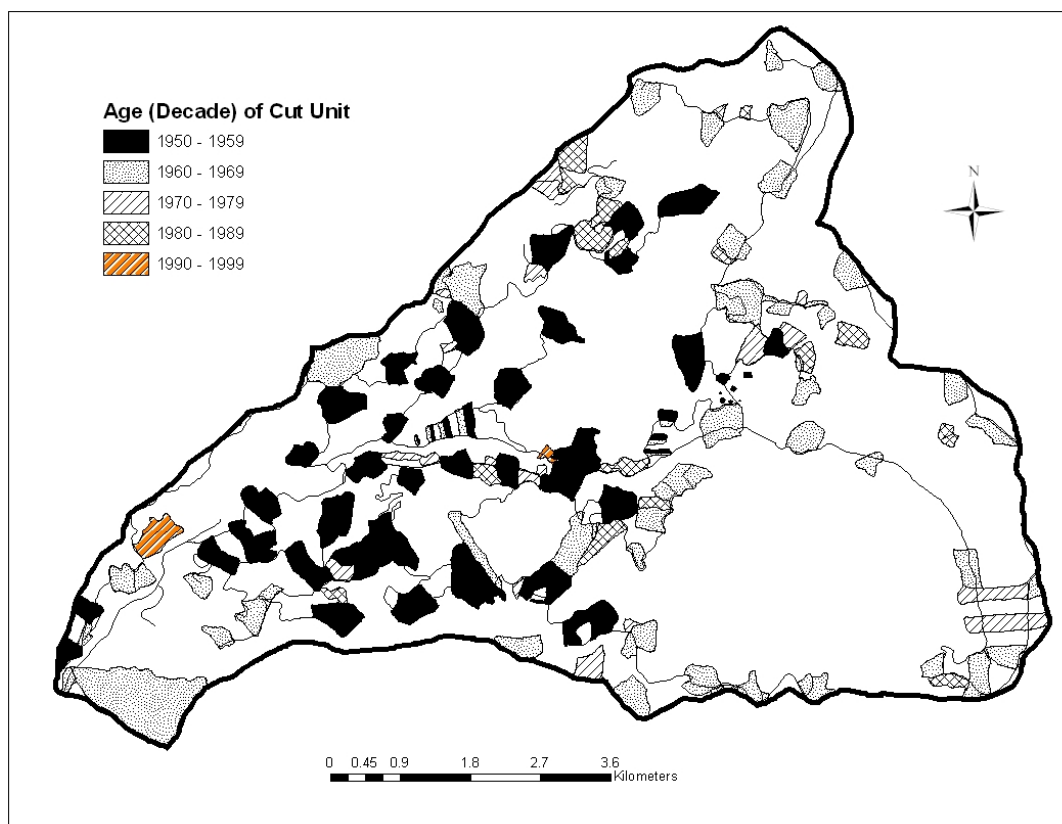

Figure 80. Landscape pattern of clear cutting adjacent to the road network at the H.J. Andrews.

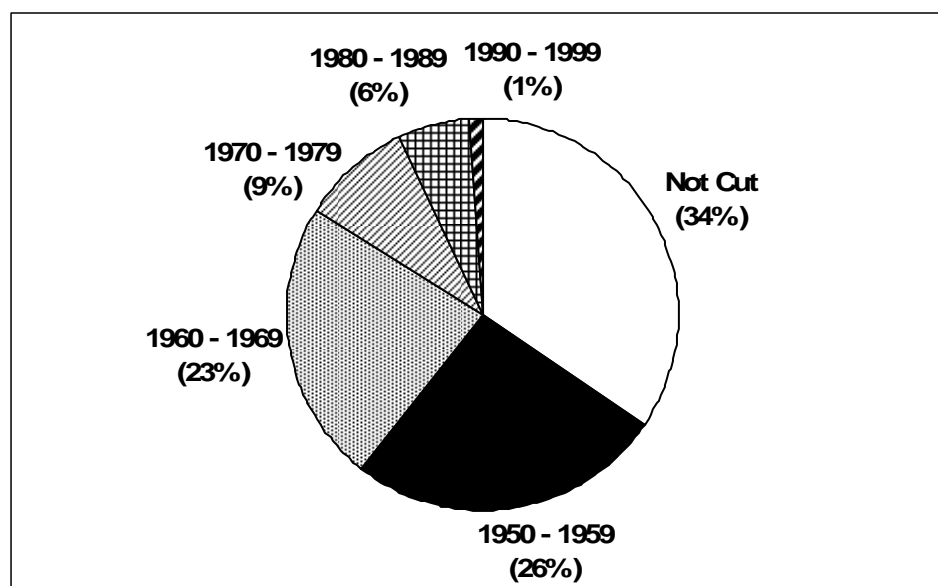

Figure 81. Percentage of road network adjacent to clear cut units, categorized by decade.

Decade of Road Construction

Road construction began at the H.J. Andrews in the 1940's, and the majority of the network was completed in the 1950's and 1960's (Figure 82). Roads at lower elevations in the center of the basin were established in the 1950's, while the network was extended to higher elevations in the 1960's. Over 96% of the road network was completed by 1960 (Figure 83). Few additional roads (4% of the network) in the northeast area were added between 1970 and 1989.

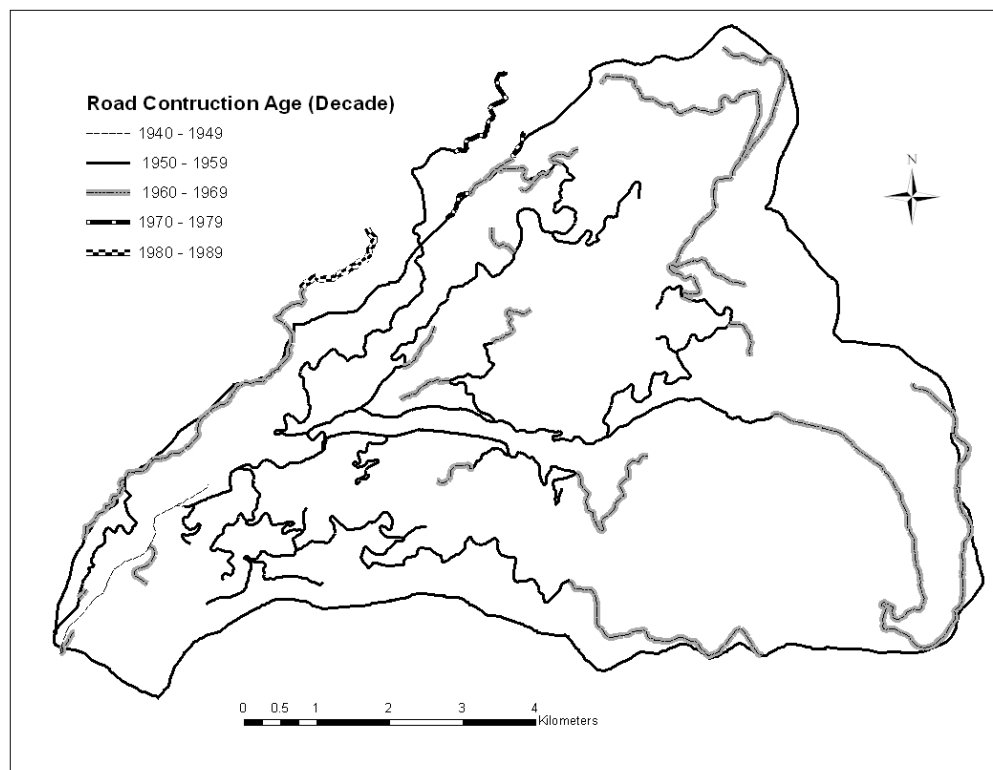

Figure 82. Landscape pattern of road construction age (by decade) at the H.J. Andrews Forest.

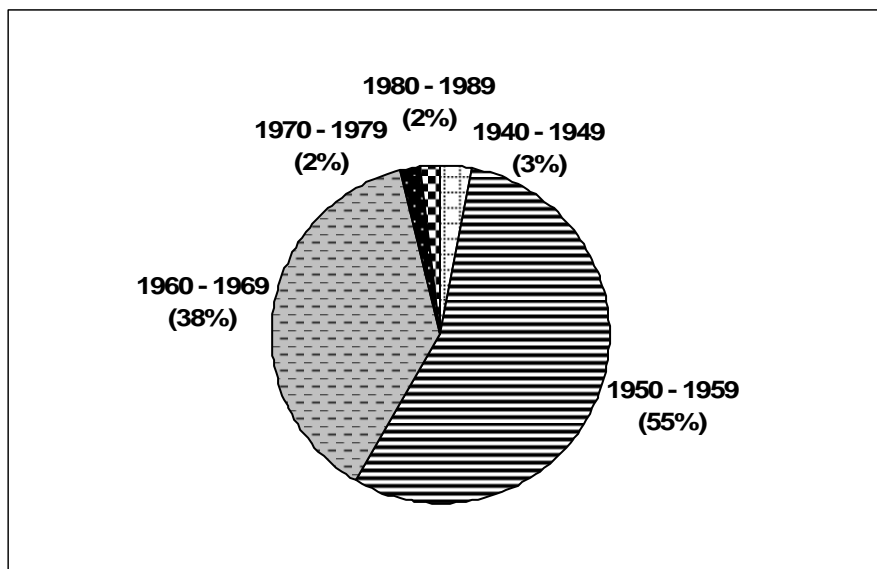

Figure 83. Percentage of road network within each road construction age (decade) class.

Road Use

The major roads at the H.J. Andrews Forest, such as roads 1506, 1508, and 350, are high-use roads that extend to the eastern and northern portions of the Lookout Creek watershed (Figure 84). Medium-use areas are extensions off of these major arteries, or the end segments of high-use roads, while low-use roads are mainly short spur roads off of more major roads. Road 1507, which climbs Lookout Ridge to the south, is also classified as low use. High-use roads comprise 43% of the network, while medium-use and low-use roads are well-represented at 32% and 25%, respectively (Figure 85).

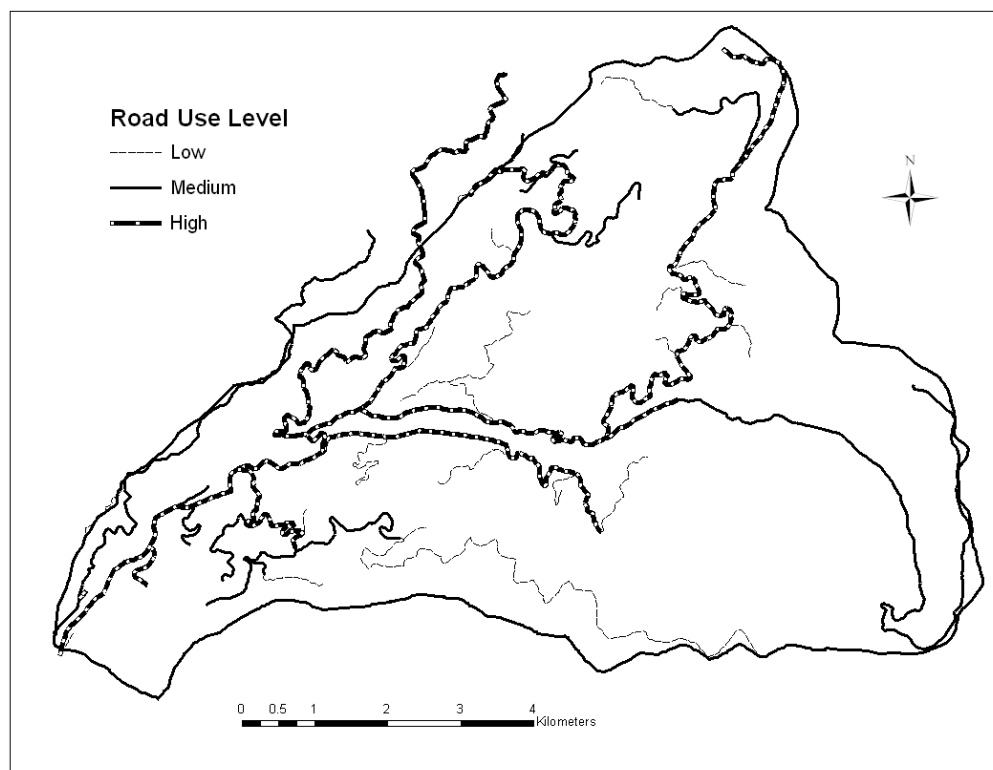

Figure 84. Landscape pattern of road use levels at the H.J. Andrews Forest.

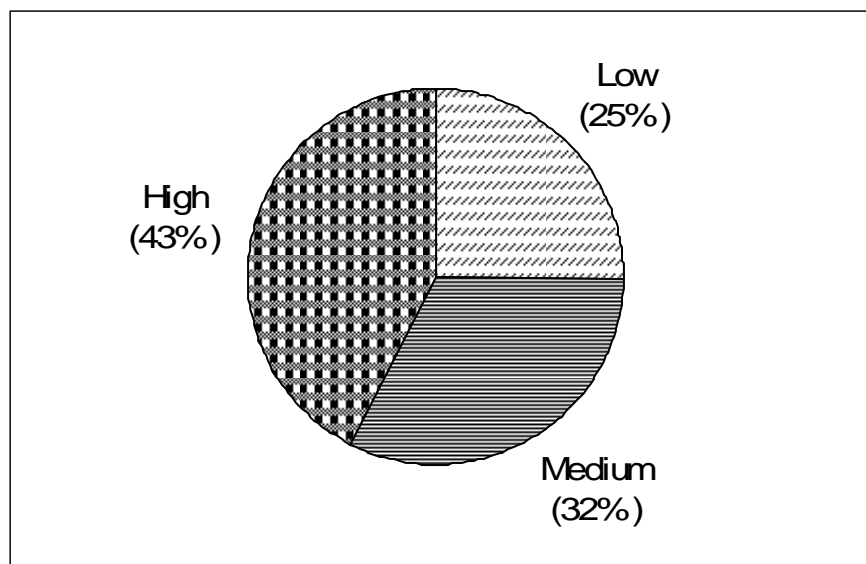

Figure 85. Percentage of road network within each road use level class.

Proximity to Gauging Stations

Stream, thermal, and rain gauging stations, accessed using the road network, are used for hydrological and climate monitoring at the H.J. Andrews. Stream gage stations are concentrated in the northern portion of the basin on tributaries of MacRae Creek adjacent to roads 327 and 410, at the mouth of Lookout Creek near roads 1506, 130, and 115, and one station located near the center of the basin on Mack Creek off of road 360 (Figure 86). Within the H.J. Andrews Forest, only 5.4% of the road network was found to be located within 250 m of a stream gauging station.

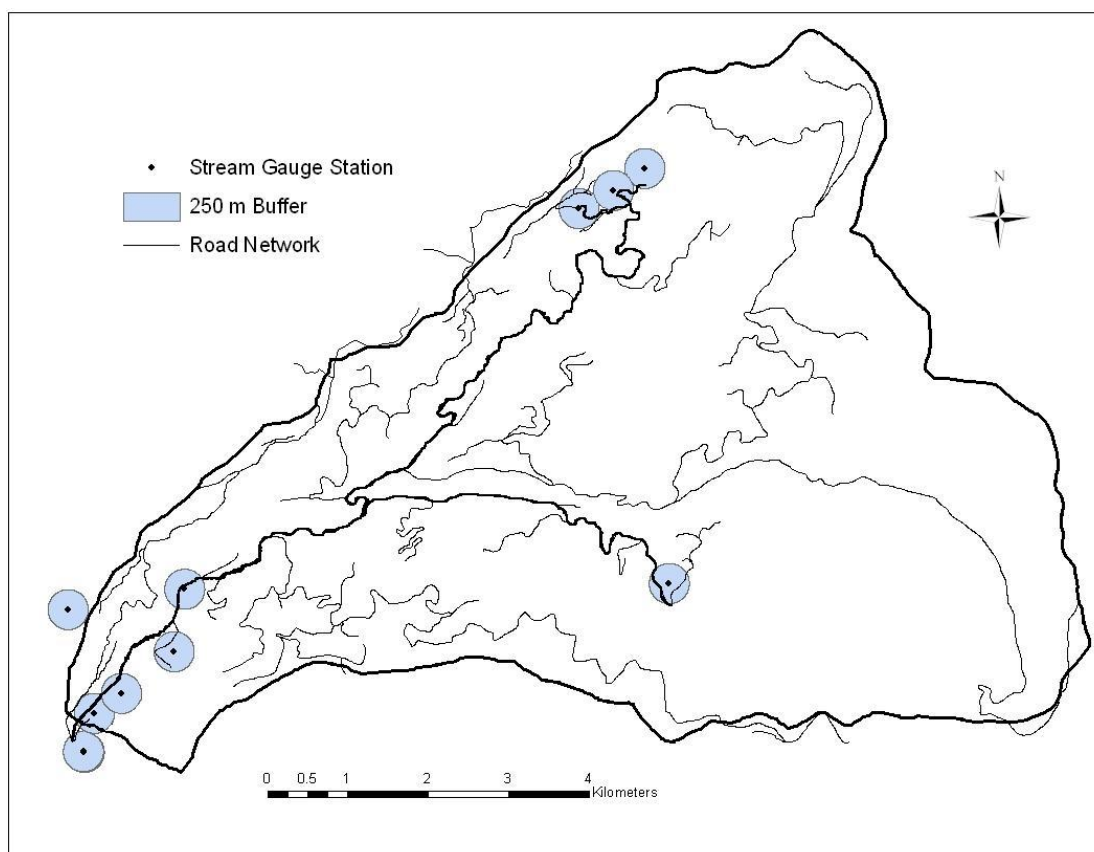

Figure 86. Location of stream gauge stations and 250-m buffers on the H.J. Andrews road network. Roads in bold are traveled often by researchers to collect data.

Thermal gage stations are more evenly distributed through the basin, with a high concentration of stations near the mouth of Lookout Creek adjacent to roads

1506, 130, 300 and 305, as well as at the northern portion near roads 410 and 327 (Figure 87). Similarly, rain gage stations are located throughout the basin, and show similar trends in clustering at the mouth of Lookout Creek and in the north near the stream and thermal gage sites (Figure 88). Thirteen percent of the H.J. Andrews Forest road network was within 250 m of a thermal gage station, while 16.7% of roads were within 250 m of a rain gage station.

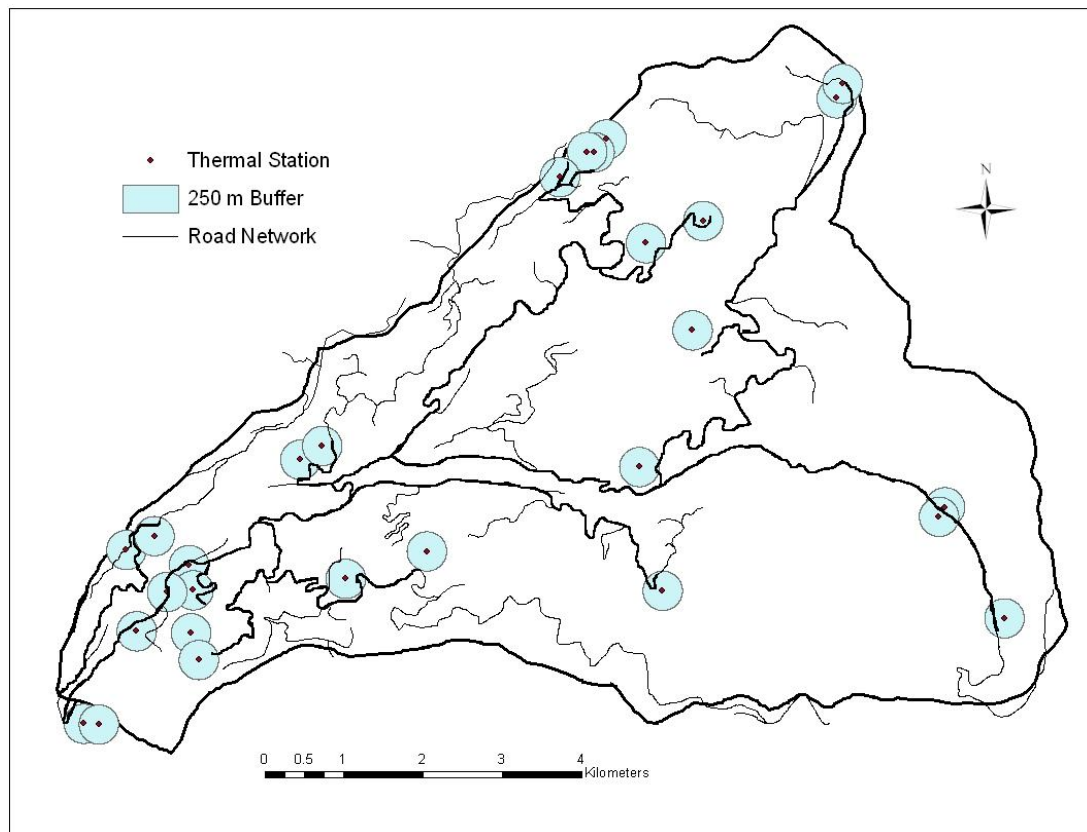

Figure 87. Location of thermal gauge stations and 250-m buffers on the H.J. Andrews road network. Roads in bold are traveled often by researchers to collect data.

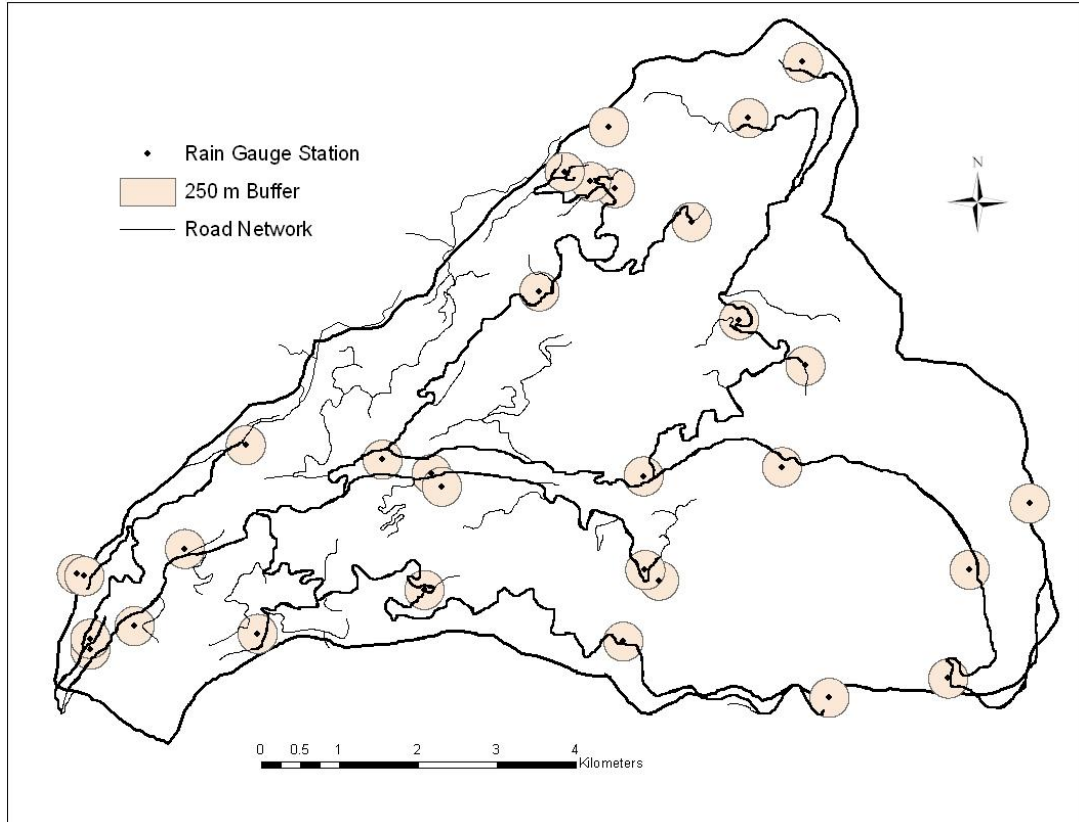

Figure 88. Location of rain gauge stations and 250-m buffers on the H.J. Andrews road network. Roads in bold are traveled often by researchers to collect data.

CART Analysis Results for the Relationship Between Landscape Variables and Exotic Species in 2005

H. perforatum

The pruned CART tree for the presence/absence of *H. perforatum* on road segments in the H. J. Andrews Forest contained five explanatory variables: elevation, decade of creation of the clearcut adjacent to the road, level of road use, proximity to rain gages, and mean annual precipitation (Figure 89). The pruned CART tree contained 7 terminal nodes and a misclassification rate of 1.4%. The most important predictor of the presence of *H. perforatum* in 2005 was elevation. *H. perforatum* was present on 95% of road segments below 600 m and above 1200 m ($n = 184$ 0.16-km

road segments), and 100% of road segments between 600 m and 1200 m (n = 451 0.16-km road segments) (Figure 89). For elevations below 600 m and above 1200 m, *H. perforatum* was present on 99% of road segments adjacent to clearcuts harvested in the 1950's, 1970's, 1990's or not cut at all (n = 138 0.16-km road segments), and only 85% of road segments adjacent to clearcuts harvested in the 1960's or 1980's (n = 47 0.16-km road segments). On road segments adjacent to clearcuts harvested in the 1960's or 1980's, *H. perforatum* was present on 96% of medium use roads (n = 24 0.16-km road segments), and only 77% of roads classified as low or high use (n = 23 0.16-km road segments). On these low or high use roads, *H. perforatum* was more frequent on road segments not near a rain gage station, where precipitation is between 2400 and 2800 mm/year. Overall, *H. perforatum* was most likely to occur on roads between 600 and 1200 m.

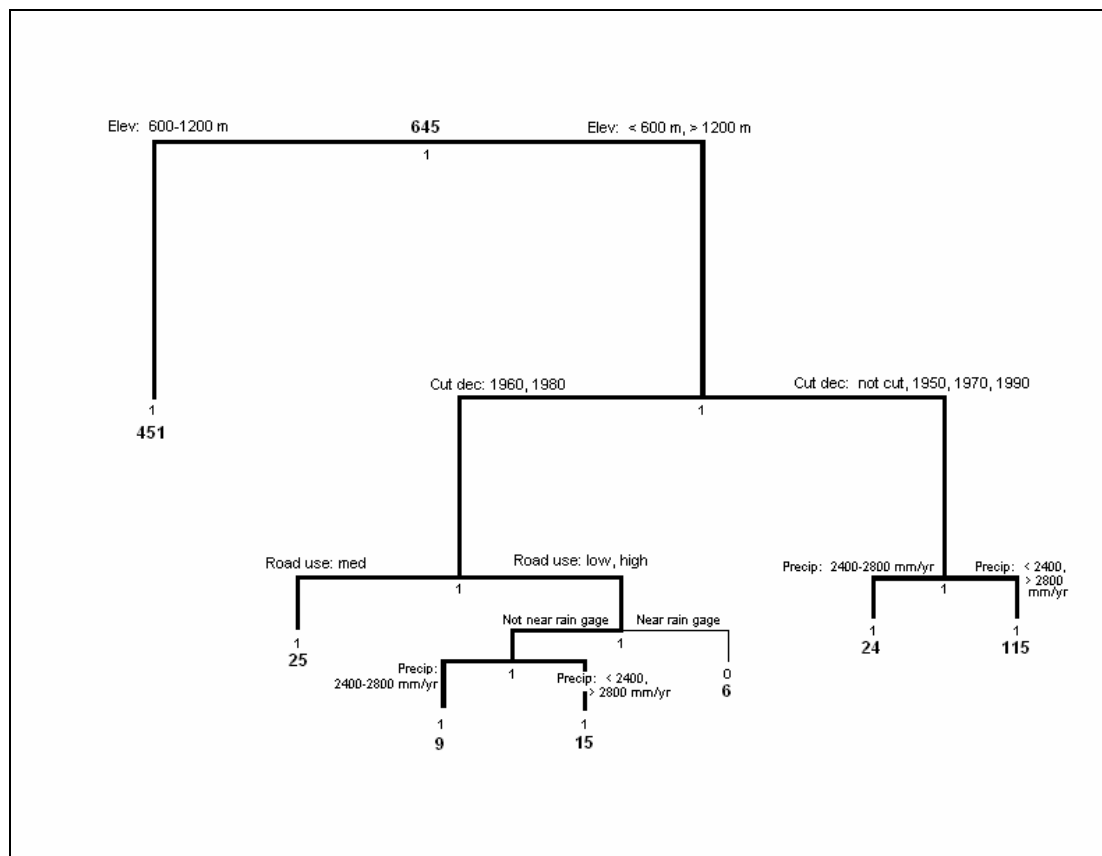

Figure 89. CART tree for the distribution of *H. perforatum* in 2005. Misclassification error rate of 1.4%.

C. leucanthemum

The pruned CART tree for the presence/absence of *C. leucanthemum* (ox-eye daisy) on road segments in the H.J. Andrews Forest contained five explanatory variables: canopy cover, elevation, level of road use, decade of road construction, and aspect (Figure 90). The pruned CART tree contained 10 terminal nodes and a misclassification error rate of 6.0%. The most important predictor of the presence of *C. leucanthemum* in 2005 was roadside canopy cover. *C. leucanthemum* was present on 98% of road segments classified as medium, medium-high, or high canopy cover (n = 421 0.16-km segments) but only 80% of segments classified as medium-low, low, or

very low canopy cover (n = 172 0.16-km segments) (Figure 90). On road segments classified as medium, medium-high, or high canopy cover, elevation was the next best predictor of the presence of *C. leucanthemum*. *C. leucanthemum* was present on 99% of road segments below 1200 m (n = 413 0.16-km segments), but only 77% of road segments above 1200 m (n = 10 0.16-km segments) (Figure 90). On road segments classified as medium-low, low, or very low canopy cover, decade of road construction was the next best predictor of *C. leucanthemum*. *C. leucanthemum* was present on 95% of roads built in the 1940's, 1950's, or 1970's (n = 79 0.16-km segments), but only 70% of roads built in either the 1960's or the 1980's (n = 92 0.16-km segments). Within road segments built in the 1960's or 1980's, *C. leucanthemum* was found on 75% of segments classified as medium-low or low (n = 91 0.16-km segments), and only 27% of segments classified as very low (n = 3 0.16-km segments). Additionally, on road segments on north or east facing slopes classified as medium-low or low canopy cover, *C. leucanthemum* was present on 78% of road segments with medium or high road traffic (n = 21 0.16-km segments), but only 38% of road segments exposed to low traffic (n = 9 0.16-km segments). Overall, *C. leucanthemum* was most likely to occur on roads with medium, medium-high or high canopy cover, at elevations below 1200 m.

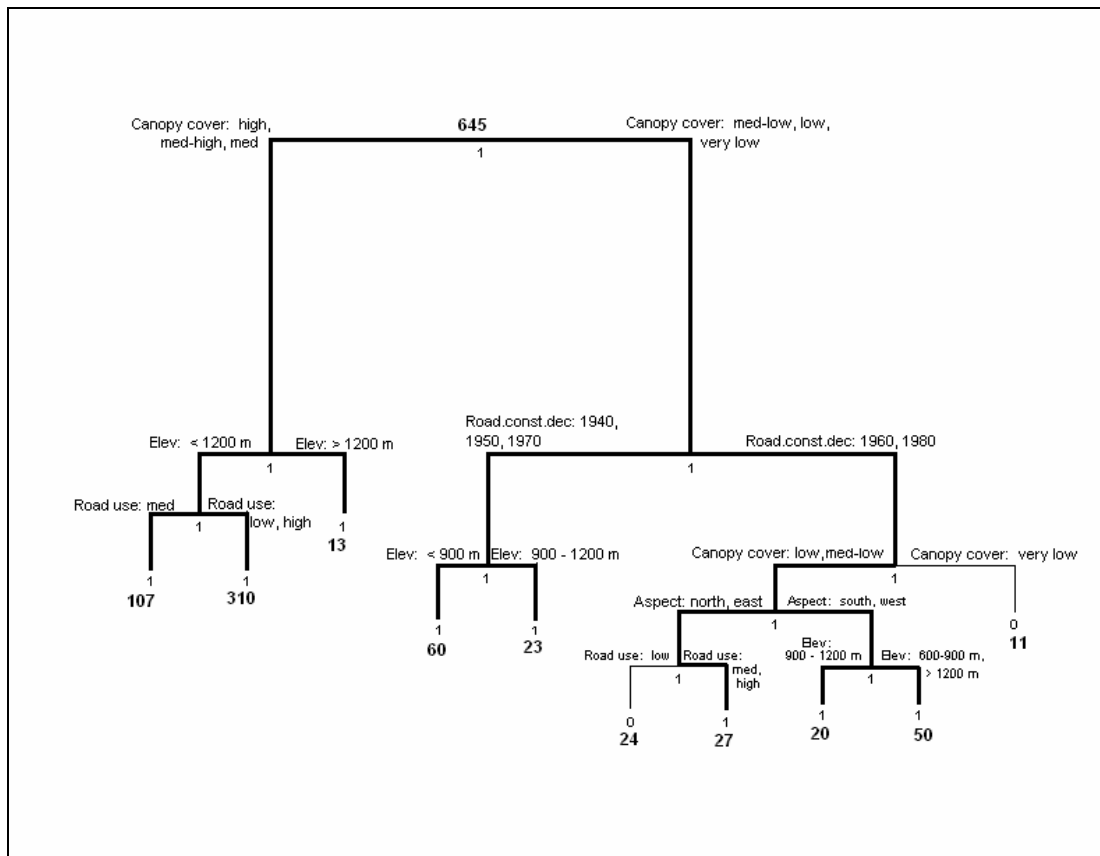

Figure 90. CART tree for the distribution of *C. leucanthemum* in 2005. Misclassification error rate of 6.0%.

L. muralis

The pruned CART tree for the presence/absence of *L. muralis* on road segments in the H. J. Andrews Forest contained seven explanatory variables: decade of road construction, level of road use, decade of creation of the clearcut adjacent to the road, canopy cover, elevation, mean annual precipitation, and proximity to thermal gages (Figure 91). The pruned CART tree contained 16 terminal nodes and a misclassification error rate of 13.6%. The most important predictor of *L. muralis* in 2005 was the decade of road construction. *L. muralis* was present on 91% of roads built before 1960 ($n = 346$ 0.16-km road segments) and only 74% of roads built after

1960 (n = 196 0.16-km road segments) (Figure 91). On roads built before 1960, *L. muralis* was present on 93% of roads classified as medium or high use (n = 280 0.16-km segments), and only 81% of low use roads (n = 64 0.16-km road segments). On roads built after 1960, *L. muralis* was present on 100% of roads with medium-high canopy cover (n = 16 0.16-km segments), and only 72% of roads with high, medium, medium-low, low, or very low canopy cover (n = 179 0.16-km segments). Of these high, medium, medium-low, low, or very low canopy covered road segments, *L. muralis* was most frequent on road segments with medium canopy cover, at elevations below 900 m, or above 1200 m. On roads with very low, low, medium-low, or high canopy cover, *L. muralis* was more frequent on road segments with mean annual precipitation below 3200 mm/year, not near thermal gages. Overall, *L. muralis* was most likely to be found on roads built before 1960, which experience medium or high levels of traffic.

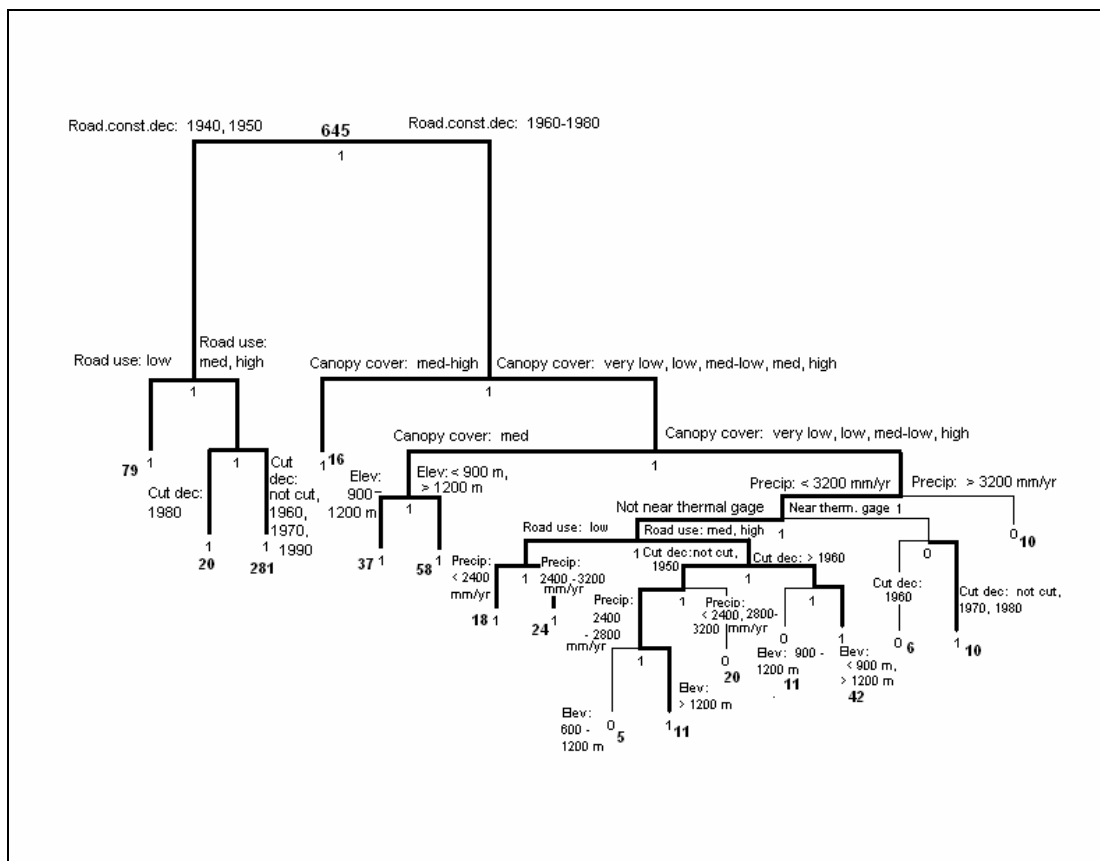

Figure 91. CART tree for the distribution of *L. muralis* in 2005. Misclassification error rate of 13.6%.

C. vulgare

The pruned CART tree for the presence/absence of *C. vulgare* on road segments in the H.J. Andrews Forest contained six explanatory variables: mean annual precipitation, elevation, decade of creation of the clearcut adjacent to the road, canopy cover, aspect, and proximity to rain gages (Figure 92). The pruned CART tree contained 15 terminal nodes and a misclassification error rate of 26.1%. The most important predictor of the presence of *C. vulgare* in 2005 was mean annual precipitation. *C. vulgare* was present on 65% of road segments with mean annual precipitation below 2400 mm/year ($n = 287$ 0.16-km segments), but on only 22% of

road segments with mean annual precipitation above 2400 mm/year ($n = 45$ 0.16-km segments) (Figure 92). On roads with precipitation below 2400 mm/year, roadside canopy cover was the next best predictor of the presence of *C. vulgare*. *C. vulgare* was present on 67% of road segments classified as low, medium-low, medium, or medium-high canopy cover ($n = 277$ 0.16-km segments), but only 36% of road segments classified as high or very low canopy cover ($n = 10$ 0.16-km segments). On segments classified as low, medium-low, medium or medium high canopy cover, *C. vulgare* was present on 70% of road segments at elevations less than 900 m ($n = 244$ 0.16-km segments), but only 52% of roads between 900 m and 1200 m ($n = 34$ 0.16-km segments). On roads with elevations between 900 m and 1200 m, *C. vulgare* was present on 58% of roads built in the 1950's and 1960's ($n = 32$ 0.16-km segments) and absent on roads built in the 1970's. On the 1950's and 1960's roads, *C. vulgare* was found on 68% of roads with medium canopy cover ($n = 27$ 0.16-km segments) and only 37% of roads with low, medium-high, or medium-low canopy cover ($n = 7$ 0.16-km segments for absence).

On road segments with mean annual precipitation above 2400 mm/year ($n = 45$ 0.16-km segments), elevation was the next best predictor for 2005 presence of *C. vulgare*. *C. vulgare* was found on 33% of roads at elevations between 600 m and 1200 m ($n = 41$ 0.16-km segments), but on only 5% of roads above 1200 meters ($n = 4$ 0.16-km segments for absence). Overall, *C. vulgare* was most likely to occur on roads with mean annual precipitation below 2400 mm/year, at intermediate levels of canopy cover (low, medium-low, medium, and medium-high estimates), and at elevations below 900 m.

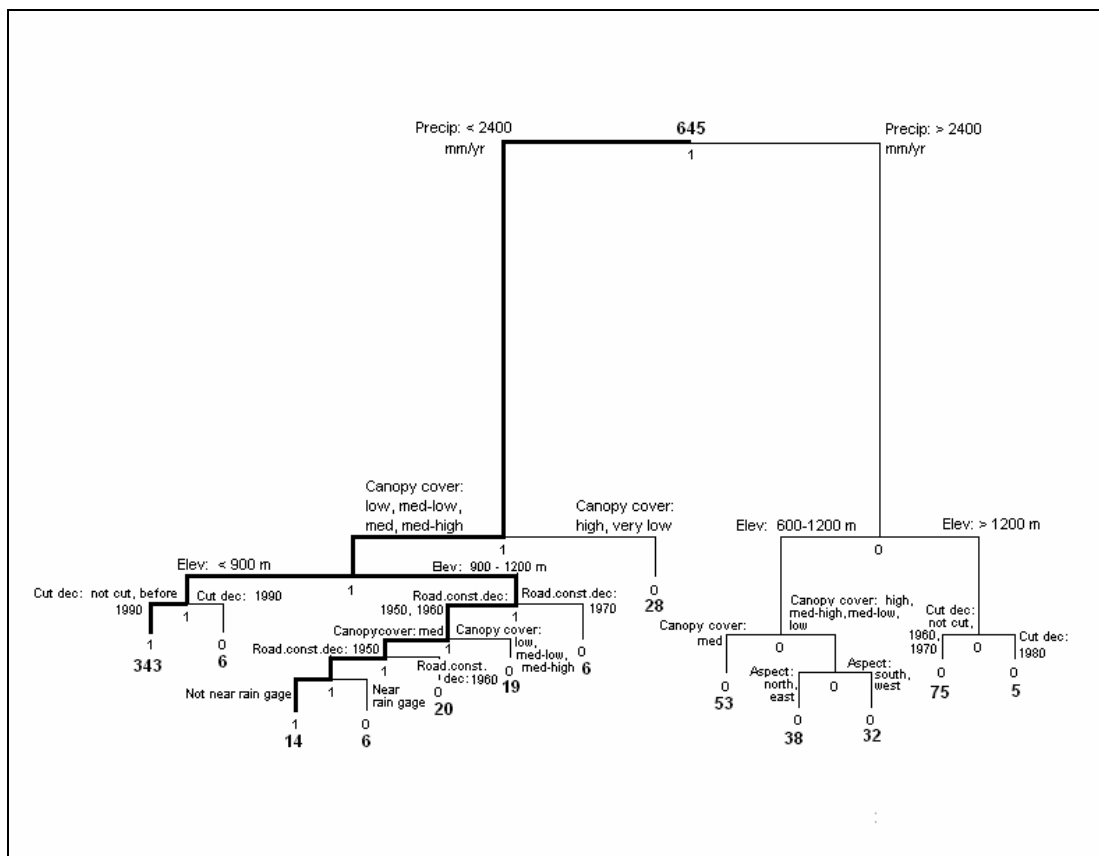

Figure 92. CART tree for the distribution of *C. vulgare* in 2005. Misclassification error rate of 26.1%.

C. scoparius

The pruned CART tree for the presence/absence of *C. scoparius* on road segments in the H. J. Andrews Forest contained six explanatory variables: elevation, canopy cover, aspect, decade of creation of the clearcut adjacent to the road, decade of road construction, and level of road use (Figure 93). The pruned CART tree contained 10 terminal nodes and a misclassification error rate of 15.5%. The most important predictor of *C. scoparius* presence in 2005 was elevation. *C. scoparius* was present on 25% of road segments below 900 m ($n = 104$ 0.16-km segments), and on only 3% of road segments above 900 m ($n = 7$ 0.16-km segments) (Figure 93). On roads below

900 m, canopy cover was the next best predictor of *C. scoparius* presence. *C. scoparius* was present on 43% of road segments categorized as very low, low, or medium-low canopy cover (n = 40 0.16-km segments), but only 20% of road segments classified as medium, medium-high, or high canopy cover (n = 64 0.16-km segments). On road segments classified as very low, medium-low, or low canopy cover, *C. scoparius* was present on 64% of road segments constructed after 1960 (n = 25 0.16-km segments), but only 27% of road segments built before 1960 (n = 15 0.16-km segments).

On road segments above 900 m (n = 7 0.16-km segments), canopy cover was the next best predictor of *C. scoparius* presence. *C. scoparius* was present on 7% of roads with low or medium canopy cover estimates (n = 81 0.16-km segments), and was absent on roads with high, medium-high, medium-low, and very low canopy cover. *C. scoparius* was also absent on east and west-facing road segments on roads with low or medium canopy cover. Overall, *C. scoparius* was most likely found on roads below 900 m, with medium-low, low, or very low canopy cover, constructed after 1960.

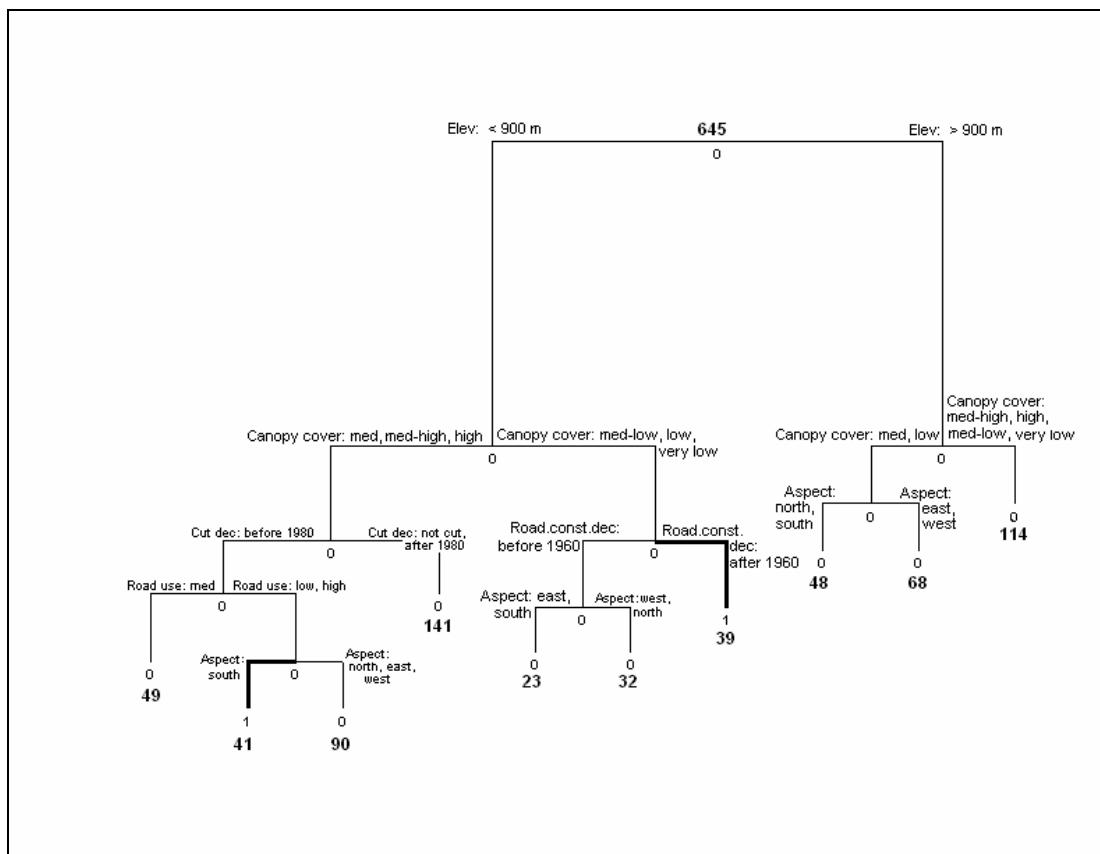

Figure 93. CART tree for the distribution of *C. scoparius* in 2005. Misclassification error rate of 15.5%.

S. jacobaea

The pruned CART tree for the presence/absence of *S. jacobaea* on road segments in the H.J. Andrews Forest contained six explanatory variables: canopy cover, elevation, decade of road construction, decade of the creation of the clearcut unit adjacent to the road, aspect, and proximity to thermal gages (Figure 94). The pruned CART tree contained 12 terminal nodes and a misclassification error rate of 25.1%. The most important predictor of the presence of *S. jacobaea* in 2005 was roadside canopy cover. *S. jacobaea* was present on 42% of road segments classified as medium, medium-high, or high canopy cover (n = 180 0.16-km segments for

absence), but only 16% of road segments classified as very low, low, or medium-low canopy cover (n = 35 0.16-km segments) (Figure 94). On medium, medium-high, or high canopy cover road segments, *S. jacobaea* was present on 54% of road segments facing north or west (n = 126 0.16-km road segments), and only 27% of road segments facing east or south (n = 53 0.16-km road segments for absence). Regardless of aspect, *S. jacobaea* was more frequent on roads with elevations between 600 and 1200 m, and less frequent on roads with elevations either above 1200 m or below 600 m.

On medium-low, low, or very low canopy cover segments (n = 35 0.16 km segments for absence), elevation was the next best predictor of *S. jacobaea* presence. *S. jacobaea* was present on 25% of roads with elevations between 600 and 1200 m (n = 30 0.16-km segments for absence), but only 5% of roads above 1200 m or below 600 m (n = 5 0.16-km segments for absence). On roads between 600 m and 1200 m, *S. jacobaea* was more frequent on roads constructed in the 1970's. Overall, *S. jacobaea* was most likely found on roads with medium, medium-high, or high canopy cover, on north or west-facing slopes, at elevations between 600 and 1200 m.

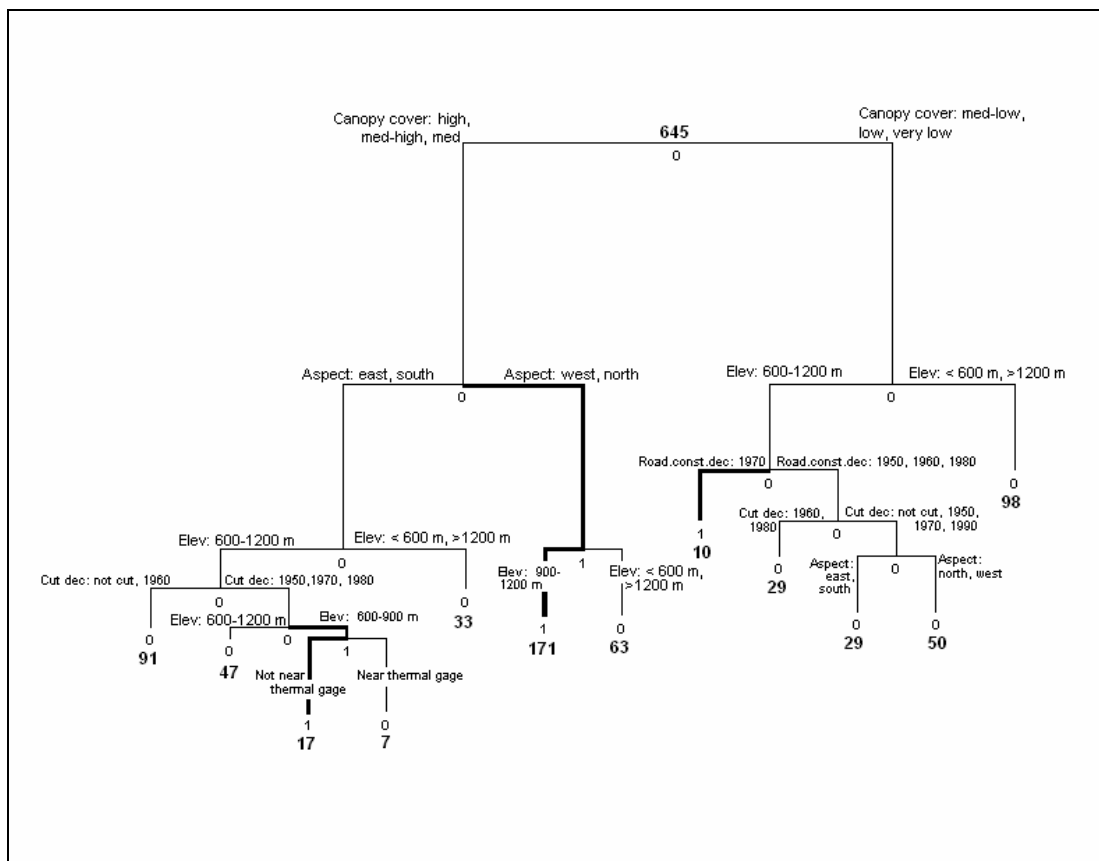

Figure 94. CART tree for the distribution of *S. jacobaea* in 2005. Misclassification error rate of 25.1%.

C. arvensis

The pruned CART tree for the presence/absence of *C. arvensis* (Canada thistle) on road segments in the H. J. Andrews Forest contained seven explanatory variables: decade of road construction, mean annual precipitation, level of road use, aspect, decade of creation of the clearcut adjacent to the road, proximity to thermal gages, and proximity to rain gages (Figure 95). The pruned CART tree contained 20 terminal nodes and a misclassification error rate of 14.6%. The most important predictor of the presence of *C. arvensis* in 2005 was the decade of road construction. *C. arvensis* was present on 20% of roads built in the 1940's, 1950's or 1970's, ($n = 79$ 0.16-km

segments), but only 7% of roads built in 1960's or 1980's (n = 18 0.16-km segments) (Figure 95).

On roads constructed in the 1940's, 1950's or 1970's, mean annual precipitation was the next best predictor of *C. arvensis* presence. *C. arvensis* was present on 22% of road segments with mean annual precipitation less than 2400 mm/year or between 2800 and 3200 mm/year (n = 77 0.16-km segments), but on only 4% of roads experiencing mean annual precipitation of 2400 to 2800 mm/year (n = 2 0.16-km segments). On roads with mean annual precipitation less than 2400 mm/year, or between 2800 and 3200 mm/year, road use was the next best predictor of *C. arvensis* presence. *C. arvensis* was present on 25% of roads classified as medium or high use (n = 69 0.16-km segments), and only 11% of roads classified as low use (n = 8 0.16-km segments). On roads classified as medium or high use, in which the decade of creation of the clearcut adjacent to the road was in the 1950's, 1960's, 1980's, 1990's or not cut at all, *C. arvensis* was present on 67% of roads built in the 1970's (n = 4 0.16-km segments), and only 25% of roads built in either the 1940's or 1950's (n = 64 0.16-km segments).

On roads constructed in the 1960's or 1980's (n = 18 0.16-km segments), the next best predictor of *C. arvensis* presence was also mean annual precipitation. *C. arvensis* was present on 16% of roads experiencing mean annual precipitation above 2800 mm/year (n = 8 0.16-km segments), but only 7% of roads with mean annual precipitation below 2800 mm/year (n = 14 0.16-km segments). Other minor variables that help explain *C. arvensis* presence/absence on roads constructed in the 1960's or 1980's include level of road use, decade of road construction, decade of creation of the

adjacent cut unit, proximity to rain gages, canopy cover, aspect, and elevation.

Overall, *C. arvense* was most likely to occur on roads built in the 1940's, 1950's, or 1970's, with mean annual precipitation either less than 2400 mm/year, or between 2800 – 3200 mm/year, on medium or high use roads.

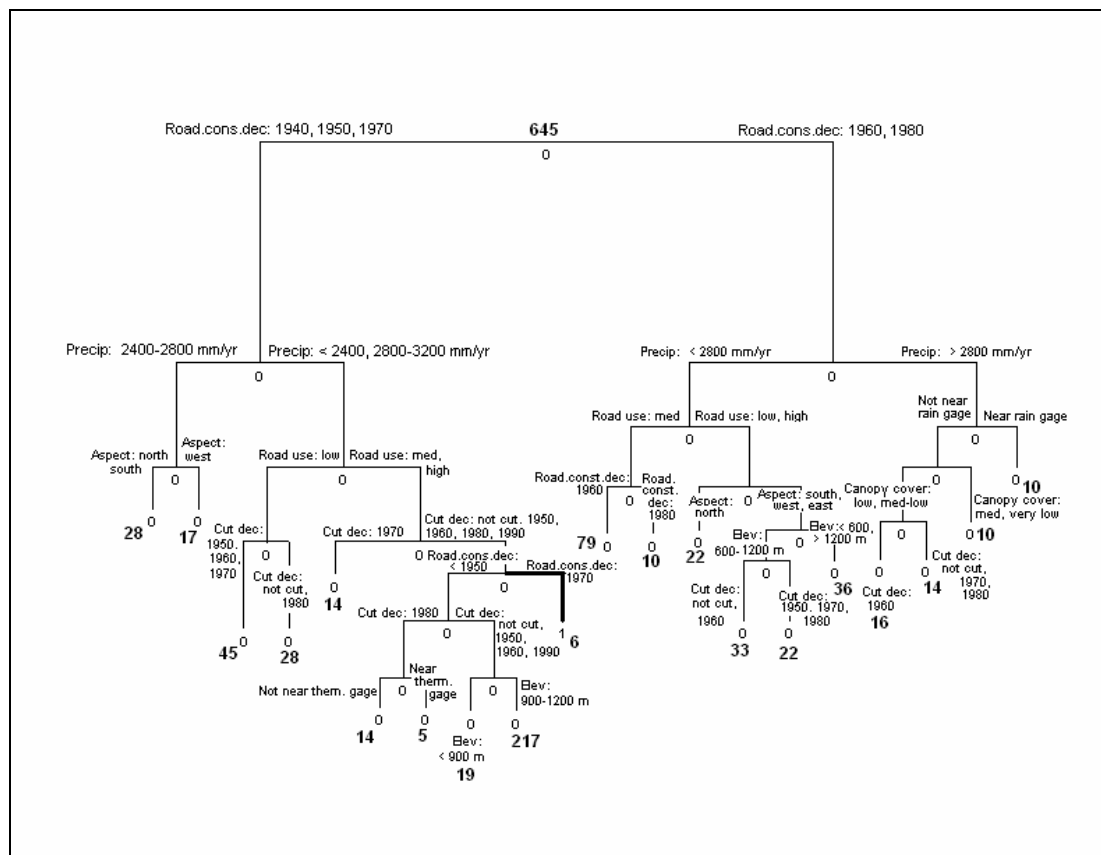

Figure 95. CART tree for the distribution of *C. arvense* in 2005. Misclassification error rate of 14.6%.

B. sylvaticum

The pruned CART tree for the presence/absence of *B. sylvaticum* (false brome) on road segments in the H.J. Andrews Forest contained five explanatory variables:

decade of road construction, aspect, mean annual precipitation, canopy cover, and decade of creation of the clearcut adjacent to the road (Figure 96). The pruned CART tree contained 9 terminal nodes and a misclassification error rate of 8.5%. The most important predictor of the presence of *B. sylvaticum* in 2005 was the decade of road construction. *B. sylvaticum* was present on 70% of road segments built in the 1940's (n = 14 0.16-km segments) but only 8% of roads built between 1950 and 1990 (n = 50 0.16-km segments) (Figure 96). On roads constructed in the 1940's, aspect was the next best predictor of the presence of *B. sylvaticum*. *B. Sylvaticum* was present on 100% of north-facing roads constructed in the 1940's (n = 10 0.16-km segments), but only 40% of south, east, and west-facing roads constructed in the 1940's (n = 4 0.16-km segments). On roads built between 1950 and 1990, mean annual precipitation was the next best predictor of the presence of *B. sylvaticum*. *B. sylvaticum* was present on 11% of road segments receiving precipitation < 2400 mm/year (n = 46 0.16-km segments) but only 2% of roads receiving > 2400 mm/year (n = 4 0.16-km segments). Within areas receiving precipitation < 2400 mm/year, *B. sylvaticum* was absent from road segments with low and very low canopy cover, and within areas receiving > 2400 mm/year, where canopy cover was classified as medium, *B. sylvaticum* was present on only 2% of road segments adjacent to clearcuts created in the 1950's, 1960's or not cut at all (n = 1 0.16-km segment). Overall, *B. sylvaticum* was most likely to occur on roads built in the 1940's, on north-facing slopes.

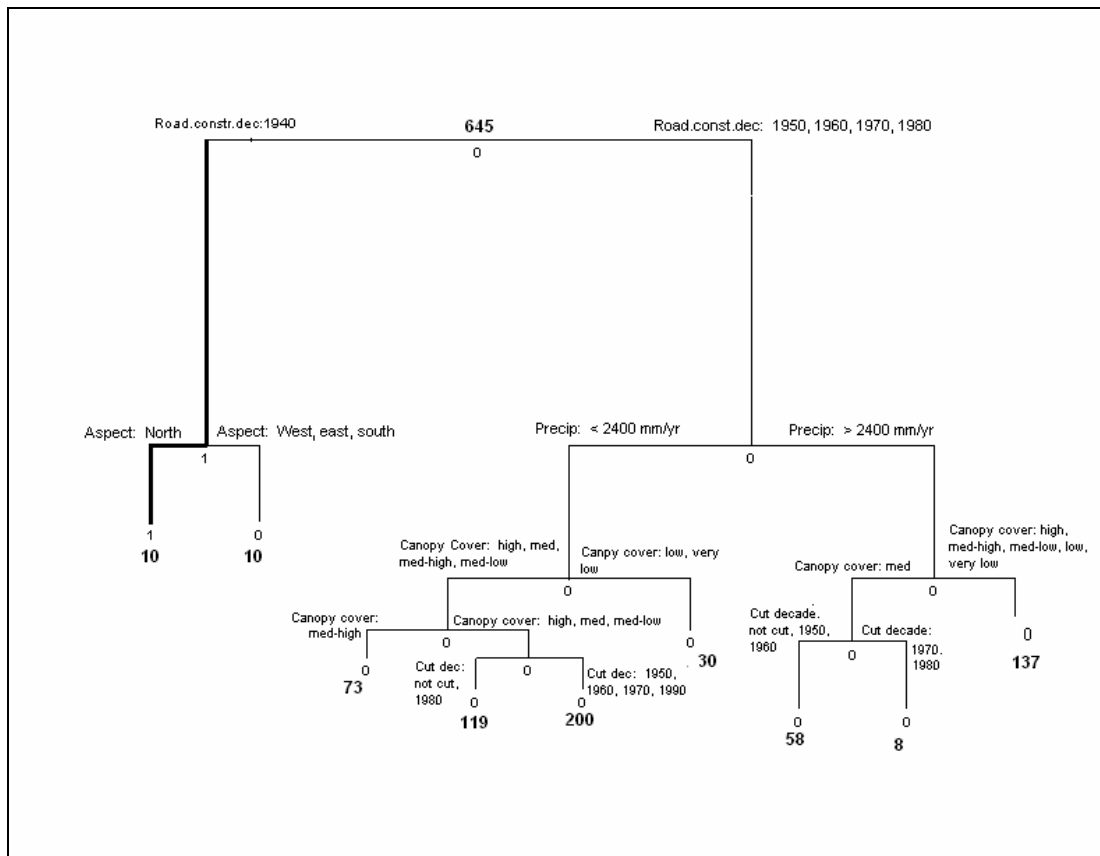

Figure 96. CART tree for the distribution of *B. sylvaticum* in 2005. Misclassification error rate of 8.5%.

D. purpurea

The pruned CART tree for the presence/absence of *D. purpurea* on road segments in the H.J. Andrews Forest contained seven explanatory variables: elevation, aspect, decade of road construction, road use, mean annual precipitation, decade of creation of the clearcut adjacent to the road, and canopy cover (Figure 97). The pruned CART tree contained 11 terminal nodes and a misclassification error rate of 6.0%. The most important predictor of the presence of *D. purpurea* in 2005 was elevation. *D. purpurea* was present on 13% of roads below 900 m, ($n = 54$ 0.16-km segments), and was absent on roads above 900 m (Figure 97). On roads below 900 m, aspect was the next best predictor of *D. purpurea* presence. *D. purpurea* was present

on 18% of roads on north, east, or west-facing aspects (n = 50 0.16-km segments), and present on only 2% of roads with south-facing aspects (n = 28 0.16-km segments). On roads with north, east, or west-facing aspects, *D. purpurea* was present on 33% of roads built in the 1940's or 1960's, (n = 27 0.16-km segments), and only 12% of roads built in the 1950's, 1970's or 1980's (n = 23 0.16-km segments). On roads constructed on the 1940's or 1960's, *D. purpurea* was present on 52% of roads classified as low or high use (n = 34 0.16-km segments), and was absent on roads classified as medium use. On low or high use roads, *D. purpurea* was most frequent on roads with medium or medium-low canopy cover that were adjacent to a clear cut unit harvested in the 1960's, 1980's, or not harvested at all. Overall, *D. purpurea* was most likely found on roads below 900 m, having north, east, or west-facing aspects, built in the 1940's or 1960's.

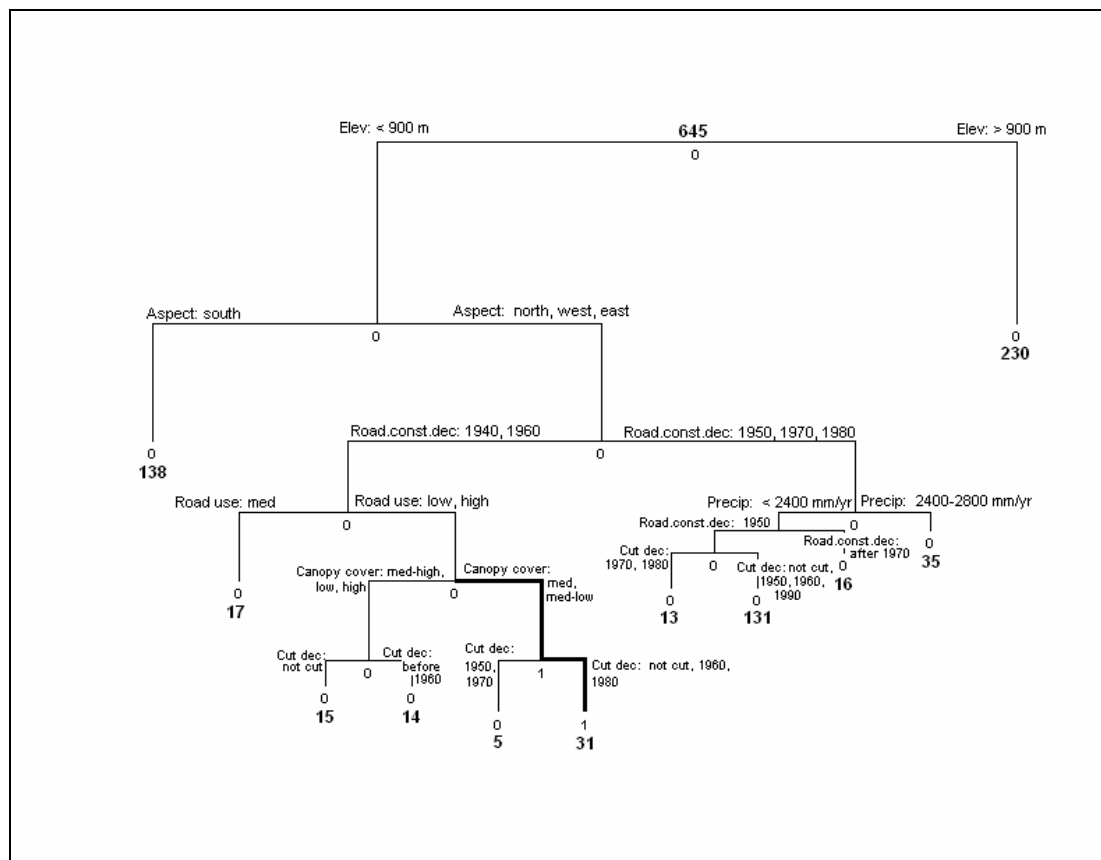

Figure 97. CART tree for the distribution of *D. purpurea* in 2005. Misclassification error rate of 6.0%.

R. discolor

The pruned CART tree for the presence/absence of *R. discolor* on road segments in the H.J. Andrews Forest contained nine explanatory variables: elevation, proximity to rain gages, decade of creation of the clearcut adjacent to the road segment, level of road use, decade of road construction, canopy cover, aspect, proximity to stream gages, and proximity to thermal gages (Figure 98). The pruned CART tree contained 17 terminal nodes and a misclassification error rate of 1.6%. The most important predictor of *R. discolor* in 2005 was elevation. *R. discolor* was present on 2% of road segments below 900 m ($n = 8$ 0.16-km segments for absence),

and was absent above 900 m (Figure 98). The next best predictor of *R. discolor* was proximity to rain gages. *R. discolor* was present on 6% of road segments within 250 m of a rain gage (n = 3 0.16-km segments), and only 2% of road segments not within 250 m of a rain gage (n = 7 0.16 km segments for absence). On those road segments near rain gages, *R. discolor* was absent on segments adjacent to a clearcut harvested in the 1950's or 1980's, and on those road segments not near rain gages, *R. discolor* was absent from low use roads. On medium and high use roads, *R. discolor* was present on 14% of roads constructed in the 1970's (n = 1 0.16-km segments for absence), and only 2% of roads constructed in other decades (n = 6 0.16-km segments for absence). Overall, *R. discolor* was most likely found on roads below 900 m, near rain gages, on road segments adjacent to clearcuts harvested in the 1960's, 1970's, or not harvested at all.

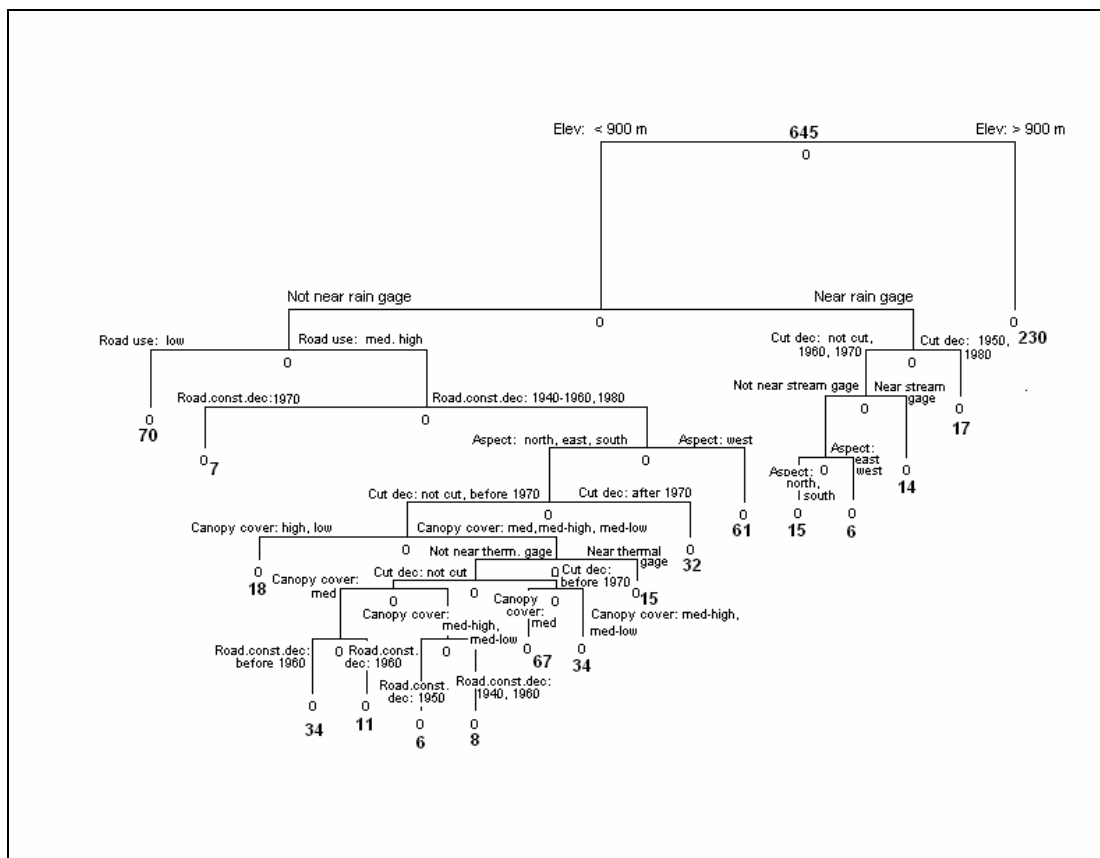

Figure 98. CART tree for the distribution of *R. discolor* in 2005. Misclassification error rate of 1.5%.

C. maculosa

The pruned CART tree for the presence/absence of *C. maculosa* (spotted knapweed) on road segments in the H. J. Andrews Forest contained four explanatory variables: decade of creation of the clearcut adjacent to the road, elevation, mean annual precipitation, and level of road use (Figure 99). The pruned CART tree contained 5 terminal nodes with a misclassification error rate of 0.4%. The most important predictor of the presence of *C. maculosa* in 2005 was the decade of creation of the clearcut adjacent to the road. *C. maculosa* was present on 8% of road segments with adjacent clearcuts harvested in the 1970's or 1980's ($n = 8$ 0.16-km segments for absence), and was absent on roads with adjacent clearcuts harvested in the 1950's,

1960's, 1990's, or not harvested at all (Figure 99). On roads in which the decade of creation of the clearcut adjacent to the road was in the 1970's or 1980's, elevation was the next best predictor of *C. maculosa* presence. *C. maculosa* was found on 25% of roads with elevation between 900 and 1200 m ($n = 8$ 0.16-km segments) and was absent on roads at elevations below 900 m or above 1200 m. Overall, *C. maculosa* was found on roads in which the decade of creation of the clearcut adjacent to the road was in the 1970's or 1980's, elevation was between 900 m and 1200 m, precipitation was below 2400 mm/year, and road use was classified as medium.

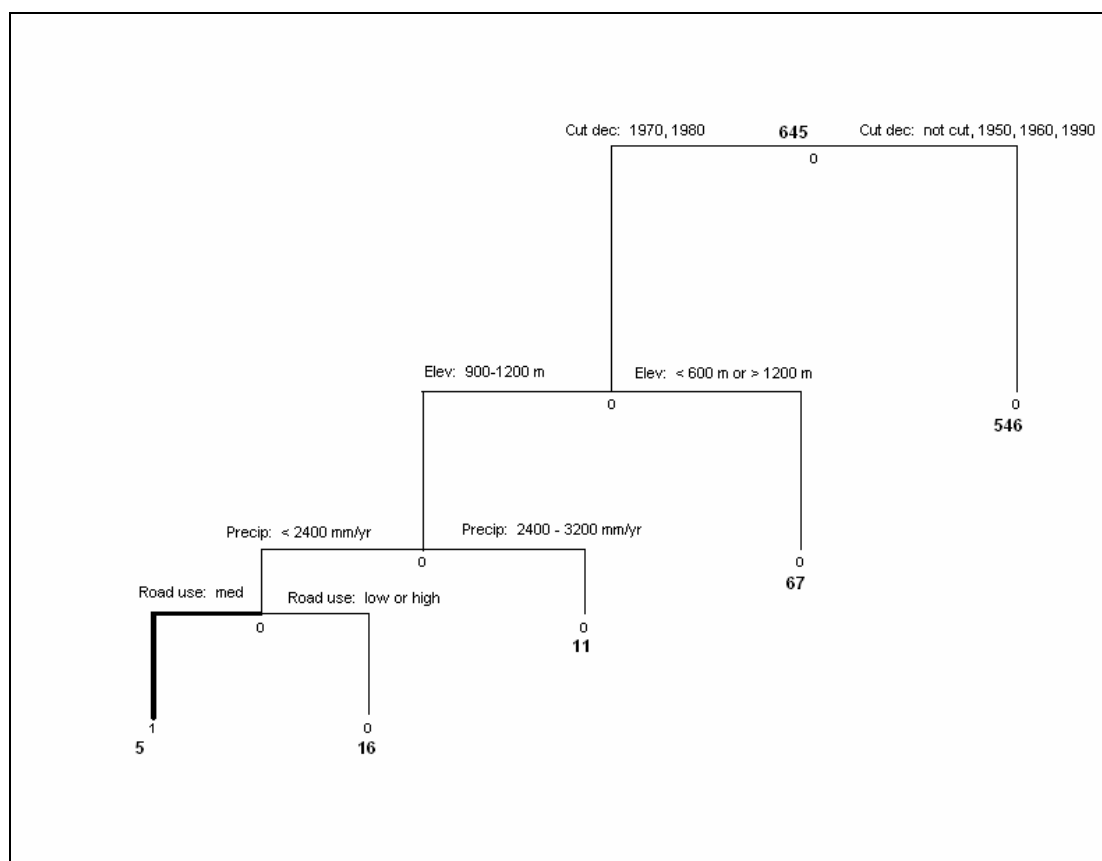

Figure 99. CART tree for the distribution of *C. maculosa* in 2005. Misclassification error rate of 0.5%.

CART Analysis Results for the Relationship Between Landscape Variables and Increase in Exotic Species from 1994 to 2005

Increase of H. perforatum

The pruned CART tree for the 11-year increase in *H. perforatum* contained seven explanatory variables: elevation, decade of road construction, canopy cover, level of road use, decade of creation of the clearcut adjacent to the road, aspect, and mean annual precipitation (Figure 100). The pruned CART tree contained 8 terminal nodes and a misclassification error rate of 5.6%. The most important predictor of the 11-year increase in *H. perforatum* was elevation. *H. perforatum* increased on 30% of road segments above 1200 m (n = 24 0.16-km segments), and only 3% of road segments below 1200 m (n = 17 0.16-km segments) (Figure 100). On road segments below 1200 m, *H. perforatum* increased on 6% of roads built in the 1940's or after 1960 (n = 12 0.16-km segments), and did not increase on road segments classified as high or medium-high canopy cover. On road segments above 1200 m, *H. perforatum* increased 50% on low use roads (n = 10 0.16-km segments for absence), and only 23% on roads with medium or high traffic (n = 14 0.16-km segments for absence). Overall, *H. perforatum* was most likely to increase on roads above 1200 m with low vehicle traffic.

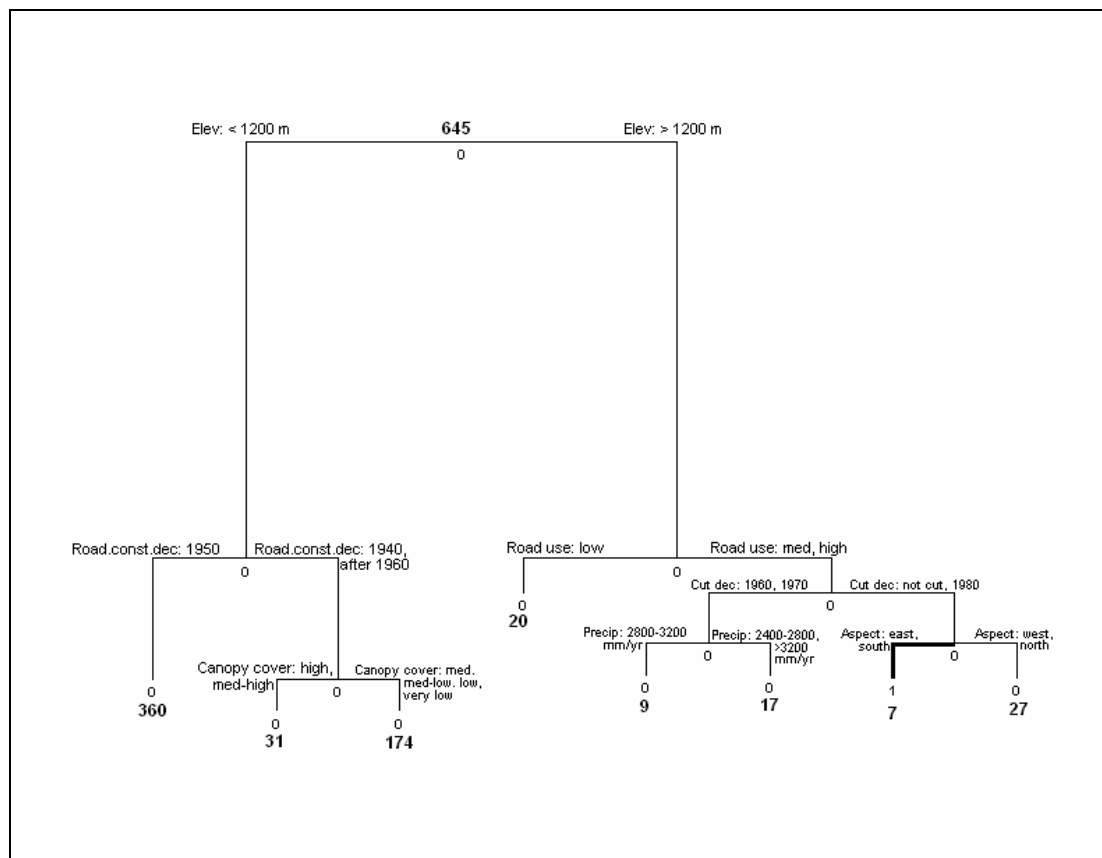

Figure 100. CART tree for the 11-year increase of *H. perforatum*. Misclassification error rate of 5.6%.

Increase of *C. leucanthemum*

The pruned CART tree for the 11-year increase of *C. leucanthemum* on road segments in the H.J. Andrews Forest contained nine explanatory variables: decade of road construction, canopy cover, level of road use, decade of the creation of the clearcut adjacent to the road, proximity to rain gages, proximity to thermal gages, elevation, aspect, and mean annual precipitation (Figure 101). The pruned CART tree contained 8 terminal nodes and a misclassification error rate of 5.6%. The most important predictor of the increase in *C. leucanthemum* over the 11-year period was the decade of road construction. *C. leucanthemum* increased 28% on roads built after

1960 (n = 74 0.16-km segments), but only 7% on roads built before 1960 (n = 27 0.16-km segments) (Figure 101). On roads built before 1960, *C. leucanthemum* increased 21% on road segments within 250 m of a thermal gage station (n = 10 0.16-km segments), and only 5% on road segments not within 250 m of a thermal gage station (n = 17 0.16-km segments). On road segments within 250 m of a thermal gage station, *C. leucanthemum* increased on 38% of roads between 600 m and 900 m (n = 8 0.16-km segments), but only 7% of roads less than 600 m and between 900 m and 1200 m (n = 2 0.16-km segments).

On roads built after 1960 (n = 74 0.16-km segments), *C. leucanthemum* increased 32% on road segments classified as very low, low, medium-low, or medium canopy cover (n = 76 0.16-km segments), and did not increase on road segments classified as medium-high or high canopy cover. On the less shaded road segments, *C. leucanthemum* increased 36% on medium or high use roads (n = 63 0.16-km segments), but only 18% on low-use roads (n = 11 0.16-km road segments). Overall, *C. leucanthemum* was most likely to increase on roads built after 1960, on segments with very low, low, or medium-low canopy cover, subject to medium or high vehicle traffic.

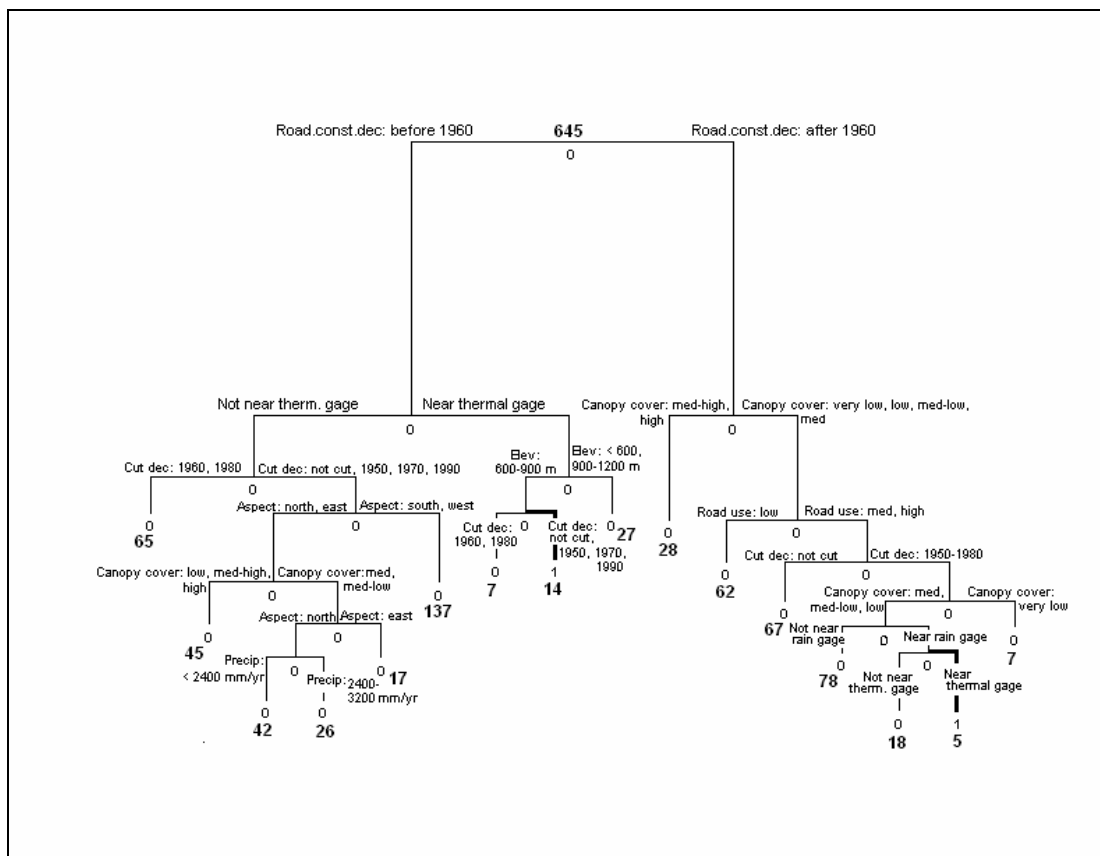

Figure 101. CART tree for the 11-year increase of *C. leucanthemum*. Misclassification error rate of 15.3%.

Increase of *C. vulgare*

The pruned CART tree for the 11-year increase of *C. vulgare* on road segments in the H.J. Andrews Forest contained seven explanatory variables: level of road use, decade of creation of the clearcut adjacent to the road, elevation, mean annual precipitation, decade of road construction, aspect, and proximity to rain gauging stations (Figure 102). The pruned CART tree contained 12 terminal nodes and a misclassification error rate of 6.2%. Level of road use was the most important predictor of the 11-year increase in *C. vulgare*. *C. vulgare* increased on 8% of medium or high use roads ($n = 38$ 0.16-km segments), but only 1% of low use roads (n

= 2 0.16-km segments) (Figure 102). Decade of the creation of the clearcut adjacent to the road was the next best predictor of *C. vulgare* increase. *C. vulgare* increased on 10% of road segments with adjacent clearcuts harvested in the 1950's, 1970's, 1980's or not harvested at all (n = 37 0.16-km segments), but only 3% of roads with adjacent clearcuts harvested in the 1960's or 1990's (n = 3 0.16-km segments). On roads with adjacent clearcuts harvested in the 1960's or 1990's, *C. vulgare* increased 19% on road segments at elevations below 600 m (n = 3 0.16-km segments), and did not increase on road segments above 600 m. Overall, *C. vulgare* increased most on roads with medium to high levels of traffic, with adjacent clearcuts harvested in the 1970's, built in the 1950's or 1980's.

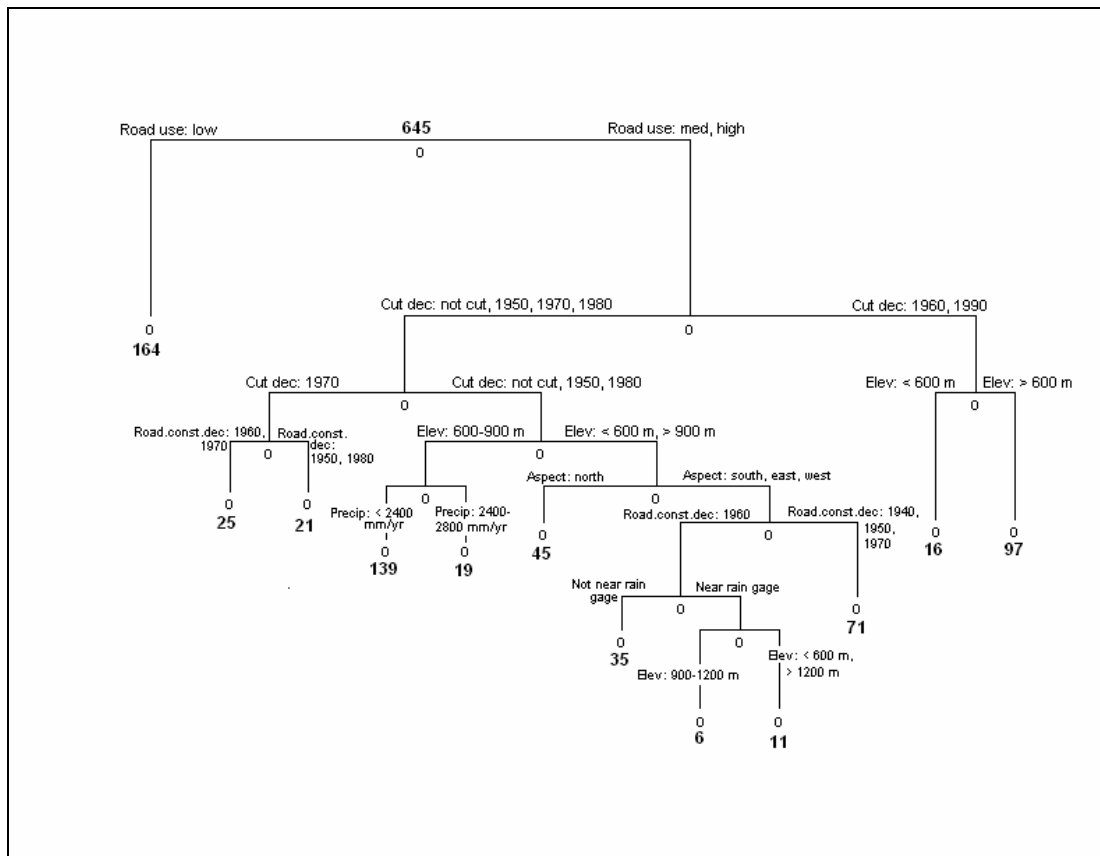

Figure 102. CART Tree for the 11-year increase of *C. vulgare*. Misclassification error rate of 6.2%.

Increase of *C. scoparius*

The pruned CART tree for the 11-year increase of *C. scoparius* on road segments in the H.J. Andrews Forest contained nine explanatory variables: elevation, canopy cover, aspect, decade of creation of the clearcut adjacent to the road, proximity to rain gages, proximity to stream gages, decade of road construction, road use, and mean annual precipitation (Figure 103). The pruned CART tree contained 14 terminal nodes and a misclassification error rate of 7.4%. The best predictor of the 11-year increase in *C. scoparius* was elevation. *C. scoparius* increased on 12% of road segments below 900 m ($n = 50$ 0.16-km segments), but only 2% of road segments

above 900 m (n = 5 0.16-km segments) (Figure 103). On roads above 900 m, *C. scoparius* increased on 4% of road segments classified as low or medium canopy cover (n = 5 0.16-km segments), demonstrated no increase on road segments classified as other canopy cover classes, and demonstrated no increase on east and west-facing slopes. On roads below 900 m, *C. scoparius* increased 19% on road segments classified as very low, low, medium-low, or medium-high canopy cover (n = 32 0.16-km segments for absence), but only 7% on medium or high canopy cover road segments (n = 17 0.16-km segments for absence). On road segments classified as medium or high canopy cover, *C. scoparius* demonstrated no increase on road segments within 250 m of a rain gage. Overall, *C. scoparius* was most likely to increase on roads below 900 m, where canopy cover is classified as very low, low, medium-low, or medium-high, and roads were constructed in the 1970's.

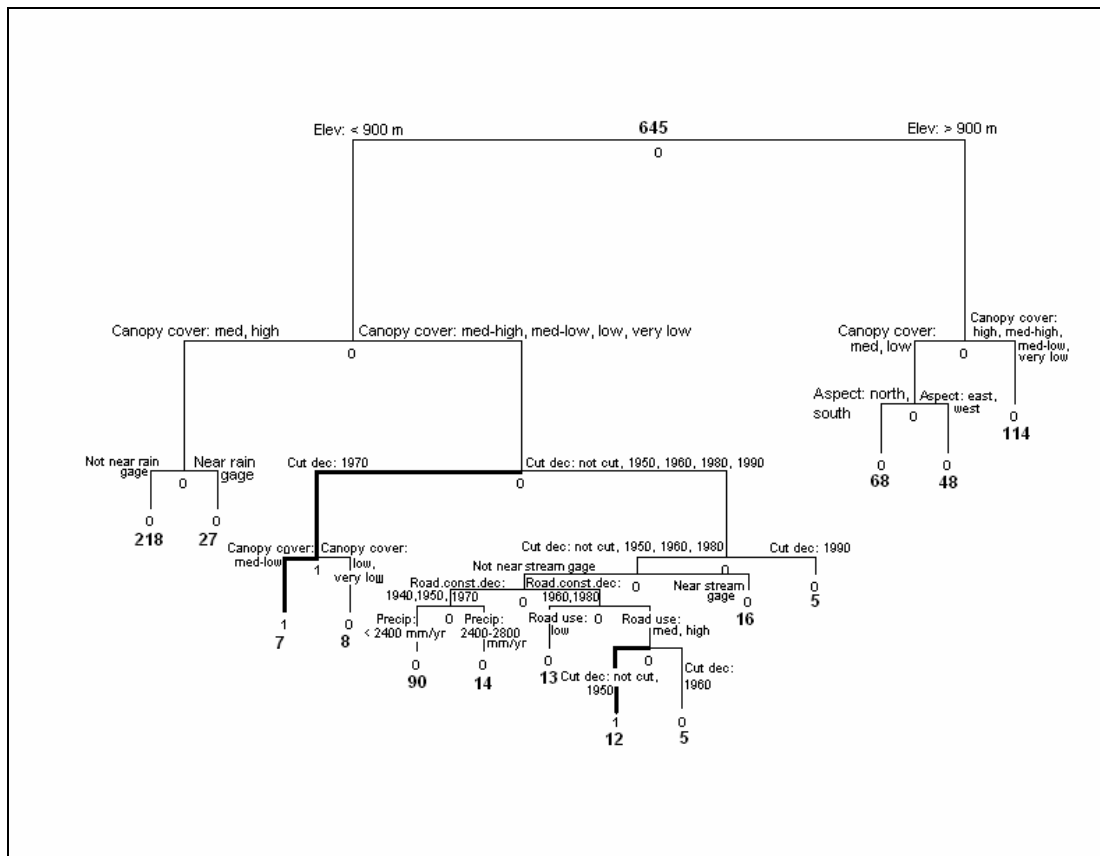

Figure 103. CART tree for the 11-year increase of *C. scoparius*. Misclassification error rate of 7.4%.

Increase of *S. jacobaea*

The pruned CART tree for the 11-year increase of *S. jacobaea* on road segments in the H.J. Andrews Forest contained eight explanatory variables: elevation, aspect, proximity to thermal gages, decade of road construction, decade of the creation of the clearcut adjacent to the road, road use, canopy cover, and mean annual precipitation (Figure 104). The pruned CART tree contained 20 terminal nodes and a misclassification error rate of 15.3%. The most important predictor of the 11-year increase in *S. jacobaea* was elevation. *S. jacobaea* increased on 20% of roads between 600 m and 1200 m ($n = 90$ 0.16-km segments), but only 6% of roads below 600 m or above 1200 m ($n = 12$ 0.16-km segments) (Figure 104). On roads below 600 m or

above 1200 m, *S. jacobaea* demonstrated no increase on segments classified as very low, low, or medium-high canopy cover. On roads between 600 m and 1200 m, *S. jacobaea* increased on 27% of roads on north and west-facing slopes (n = 66 0.16-km segments), but only 13% on roads with east or south facing slopes (n = 27 0.16- km segments) and demonstrated more increase on roads with adjacent clearcuts harvested in the 1950's, or after the 1970's. Overall, *S. jacobaea* was more likely to increase on roads between 600 m and 1200 m, on north or west-facing slopes, where mean annual precipitation is below 2800 mm/year.

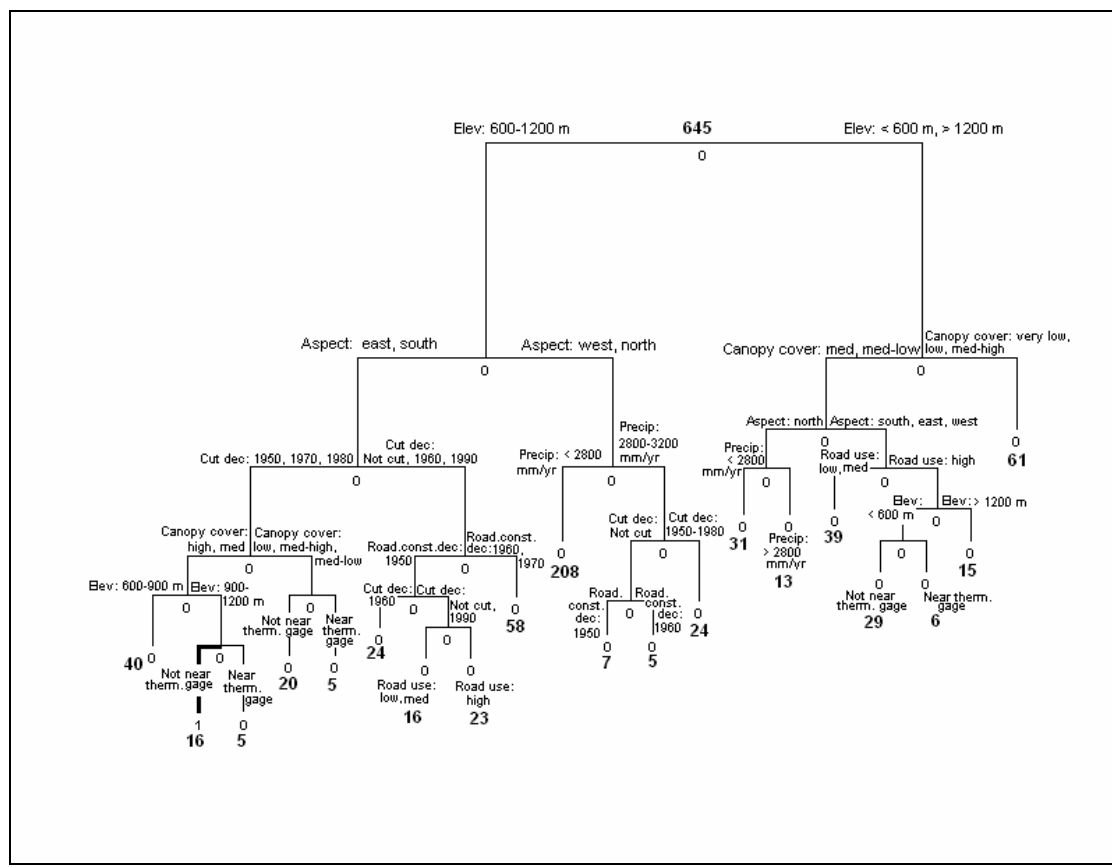

Figure 104. CART tree for the 11-year increase of *S. jacobaea*. Misclassification error rate of 15.3%.

Increase of *C. arvensis*

The pruned CART tree for the increase of *C. arvensis* on road segments in the H.J. Andrews Forest contained nine explanatory variables: decade of road construction, elevation, proximity to stream gages, decade of creation of the clearcut adjacent to the road, aspect, level of road use, canopy cover, proximity to thermal gages, and mean annual precipitation (Figure 105). The pruned CART tree contained 21 terminal nodes and a misclassification error rate of 7.9%. The most important predictor of the increase in *C. arvensis* over the 11-year period was the decade of road construction. *C. arvensis* increased 10% on roads constructed in the 1940's, 1950's or 1970's (n = 39 0.16-km segments), but only 4% on roads constructed in the 1960's or 1980's (n = 10 0.16-km segments) (Figure 105). On these 1960's and 1980's constructed roads, *C. arvensis* increased 9% on roads below 600 meters or above 1200 meters (n = 8 0.16-km segments), and only 1% on roads between 600 and 1200 meters (n = 2 0.16-km segments). On roads below 600 meters or above 1200 meters, *C. arvensis* increased 40% on roads within 250 m of a stream gage (n = 2 0.16-km segments), and only 7% on roads not within 250 m of a stream gage (n = 6 0.16-km segments).

On roads constructed before 1960 or during the 1970's, the next best predictor of the increase in *C. arvensis* was canopy cover. *C. arvensis* increased on 18% of road segments classified as low or medium low canopy cover (n = 15 0.16-km segments), and only 8% of roads classified as medium, medium-high, or high canopy cover (n = 25 0.16-km segments). On these more shaded roads, *C. arvensis* increased 10% on roads with medium or high levels of traffic (n = 25 0.16-km segments), and only 3%

of low-use roads (n = 20.16- km segments). On low-use roads, *C. arvensis* increased on east and south-facing slopes and did not increase on north and west-facing slopes, but on medium or high use roads, *C. arvensis* increased on road segments with all aspects *except* east facing slopes. Overall, *C. arvensis* was most likely to increase on roads constructed before 1960 or during the 1970's, on segments classified as low or medium low canopy cover.

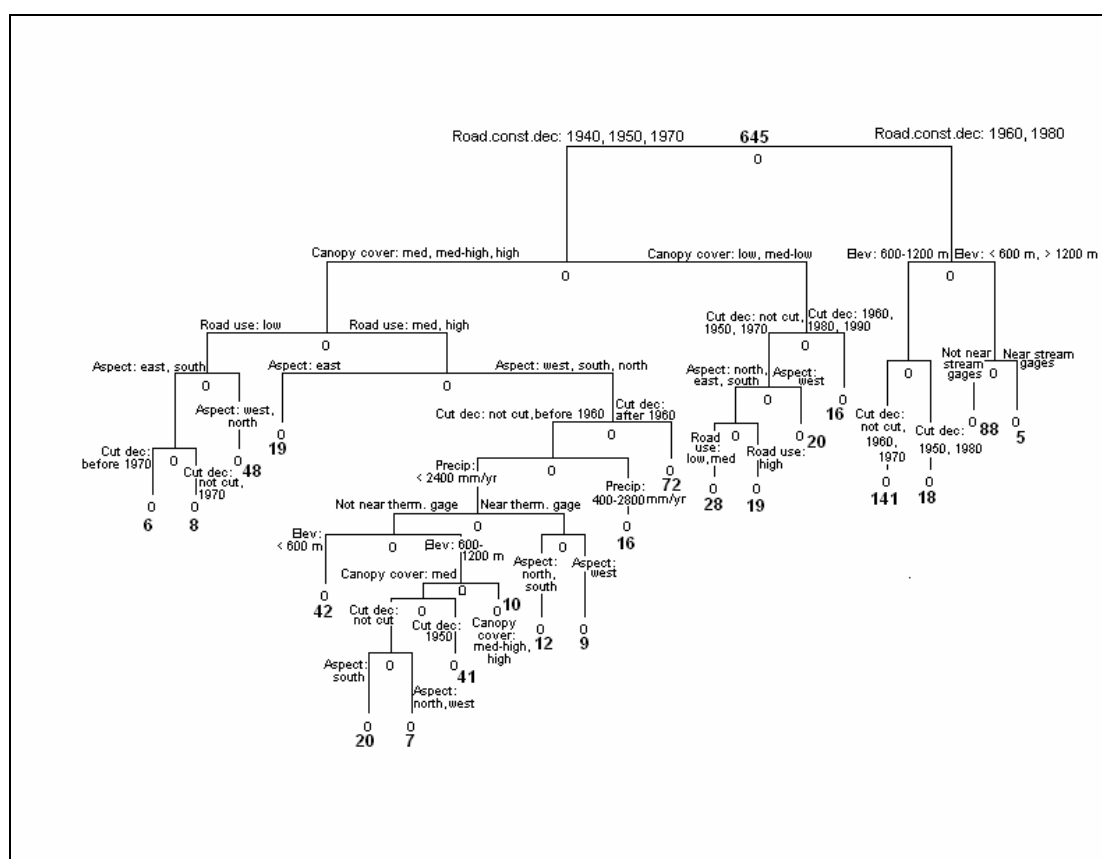

Figure 105. CART tree for the 11-year increase of *C. arvensis*. Misclassification error rate of 7.9%.

Increase of *D. purpurea*

The pruned CART tree for the 11-year increase in *D. purpurea* on road segments in the H.J. Andrews Forest contained six explanatory variables: elevation,

aspect, decade of road construction, level of road use, decade of creation of the clearcut adjacent to the road, and canopy cover (Figure 106). The pruned CART tree contained 10 terminal nodes and a misclassification error rate of 6.0%. The most important predictor of the increase in *D. purpurea* over the 11-year period was elevation. *D. purpurea* increased on 12% of road segments below 900 m (n = 50 0.16-km segments), and demonstrated no increase above 900 m (Figure 106). *D. purpurea* also increased on 17% of north, east, or west-facing slopes (n = 47 0.16-km segments), and only 1% of south-facing slopes (n = 1 0.16-km segments). Overall, *D. purpurea* was most likely to increase on elevations below 900 m, on north, east, or west-facing slopes, on roads built in the 1940's or 1960's, where road use was classified as either low or high.

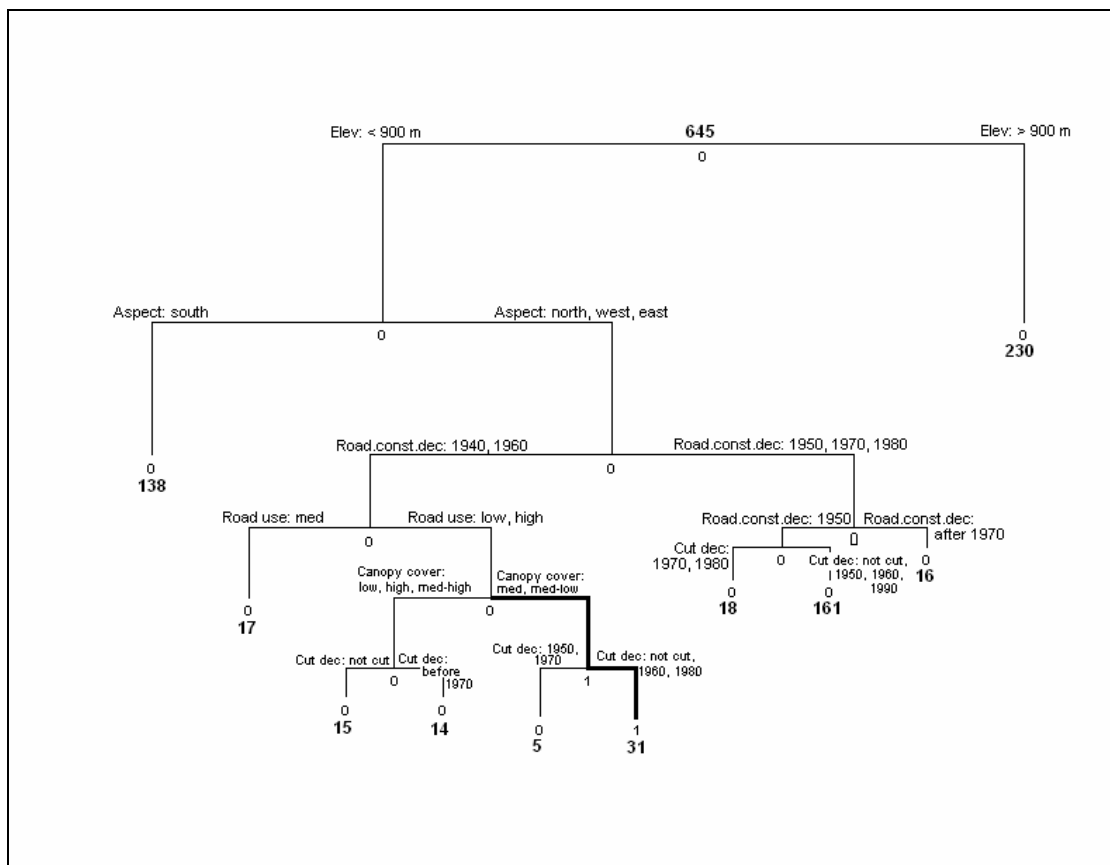

Figure 106. CART tree for the 11-year increase of *D. purpurea*. Misclassification error rate of 6.0%.

Increase of *R. discolor*

The pruned CART tree for the 11-year increase in *R. discolor* on road segments in the H.J. Andrews Forest contained eight explanatory variables: elevation, level of road use, decade of road construction, aspect, canopy cover, decade of creation of the clearcut adjacent to the road, proximity to rain gages, and proximity to thermal gages (Figure 107). The pruned CART tree contained 16 terminal nodes and a misclassification error rate of 7.7%. The most important predictor of the 11-year increase of *R. discolor* was elevation. *R. discolor* increased on 2% of roads below 900 m ($n = 8$ 0.16- km segments), and did not increase on any road segments above 900 m

(Figure 107). *R. discolor* also increased on 2% of roads classified as medium or high use ($n = 7$ 0.16-km segments), and did not increase on low use roads. *R. discolor* increased on 7% of roads constructed in the 1940's and 1970's ($n = 2$ 0.16-km segments), but only 2% of roads constructed during the 1950's, 1960's, or 1980's ($n = 6$ 0.16-km segments), and did not increase on west-facing slopes on these roads. Overall, *R. discolor* was most likely to increase on roads below 900 m, subject to medium or high levels of traffic, built during the 1940's or 1970's.

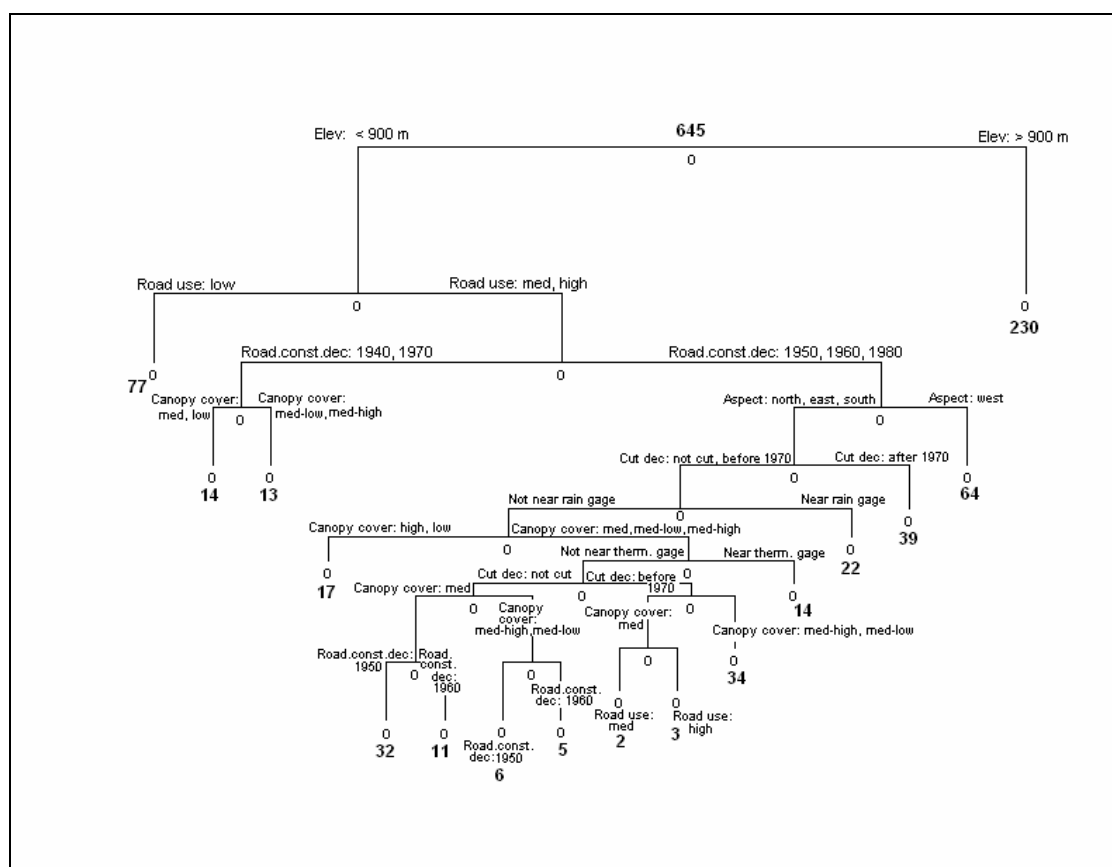

Figure 107. CART tree for the 11-year increase of *R. discolor*. Misclassification error rate of 7.7%.

CART Analysis Results for the Relationship Between Landscape Variables and Decrease in Exotic Species from 1994 to 2005

Decrease of H. perforatum

The pruned CART tree for the 11-year decrease of *H. perforatum* on road segments in the H.J. Andrews Forest contained three explanatory variables: proximity to stream gages, decade of the creation of the clearcut adjacent to the road, and decade of road construction (Figure 108). The pruned CART tree contained 4 terminal nodes and a misclassification error rate of 0.3%. The most important predictor of 11-year decrease in *H. perforatum* was proximity to stream gauging stations. *H. perforatum* decreased on 6% of road segments within 250 m of a stream gauging station (n = 2 0.16-km segments), and demonstrated no decrease on road segments not within 250 m of a stream gauging station (Figure 108). *H. perforatum* also demonstrated no decrease on road segments adjacent to a clearcut harvested in the 1950's, 1970's, 1980's, or not clearcut at all. Overall, *H. perforatum* decreased on road segments within 250 m of a stream gauging station, which are adjacent to a clearcut harvested in the 1960's, on roads constructed in the 1960's.

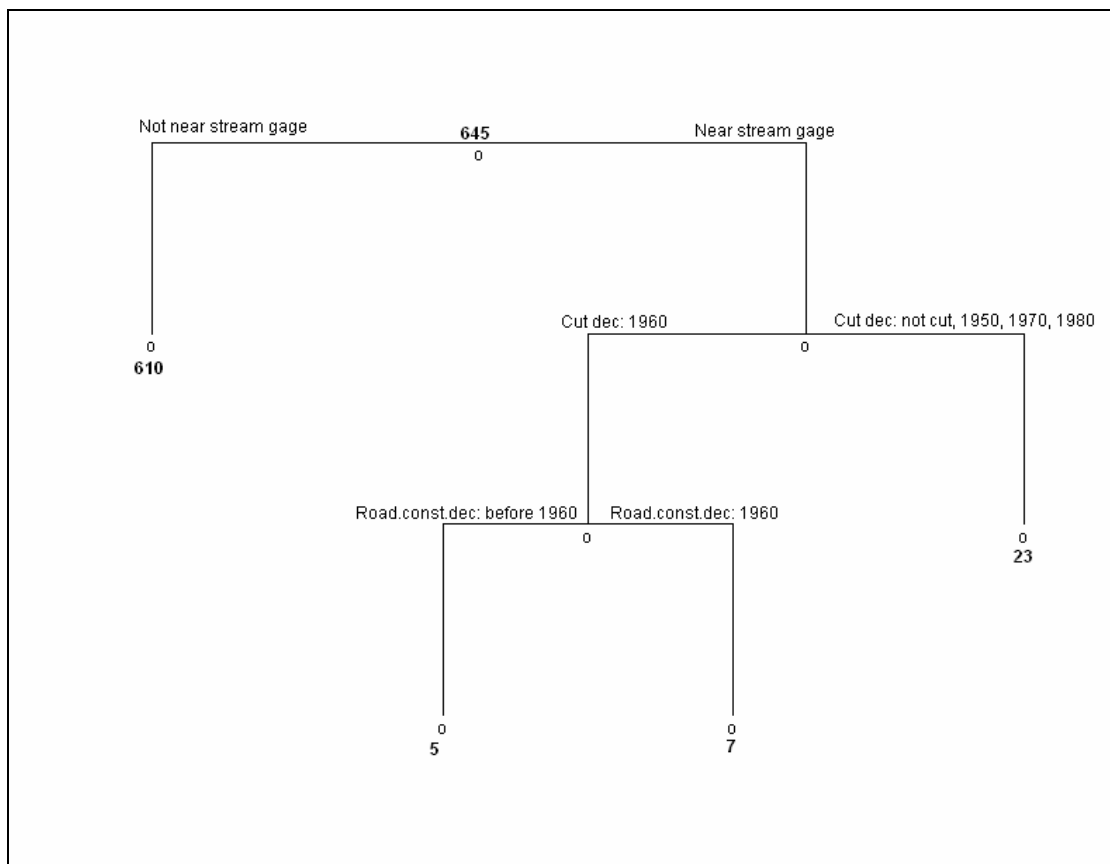

Figure 108. CART tree for the 11-year decrease of *H. perforatum*. Misclassification error rate of 0.3%.

Decrease of *C. leucanthemum*

The pruned CART tree for the 11-year decrease of *C. leucanthemum* on road segments in the H.J. Andrews Forest contained three explanatory variables: canopy cover, decade of creation of the clearcut adjacent to the road, and elevation (Figure 109). The pruned CART tree contained 6 terminal nodes and a misclassification error rate of 0.3%. The most important predictor of the 11-year decrease of *C. leucanthemum* was roadside canopy cover. *C. leucanthemum* decreased on 27% of road segments classified as very low canopy cover ($n = 3$ 0.16-km segments), but only on 1% of road segments classified as low, medium-low, medium, medium-high, or high canopy cover ($n = 6$ 0.16-km segments) (Figure 109). On these more shaded

roads, *C. leucanthemum* decreased on 2% of roads below 600 m or between 900 m and 1200 m ($n = 5$ 0.16-km segments), and no decrease occurred on roads between 600 and 900 m, or above 1200 m. Overall, *C. leucanthemum* was most likely to decrease on road segments with very low canopy cover, where the clearcut adjacent to the road was harvested in the 1970's.

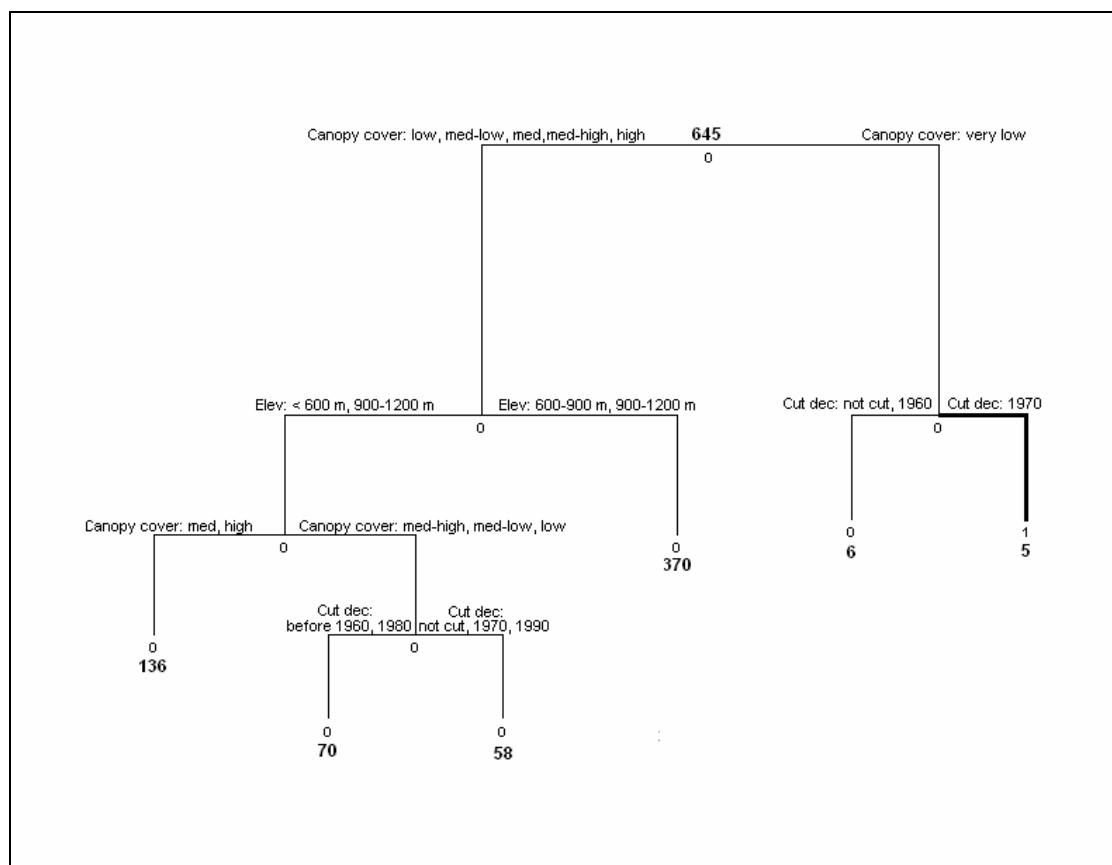

Figure 109. CART tree for the 11-year decrease of *C. leucanthemum*. Misclassification error rate of 0.3%.

Decrease of *C. vulgare*

The pruned CART tree for the 11-year decrease of *C. vulgare* on road segments in the H.J. Andrews Forest contained eight explanatory variables: decade of

creation of the clearcut adjacent to the road, proximity to rain gages, elevation, mean annual precipitation, canopy cover, level of road use, aspect, and decade of road construction (Figure 110). The pruned CART tree contained 20 terminal nodes and a misclassification error rate of 22.6%. The most important predictor of decrease for *C. vulgare* over the 11-year period was decade of the creation of the clearcut adjacent to road segments. *C. vulgare* decreased on 29% of road segments with adjacent clearcuts harvested after 1960, or not clearcut at all (n = 138 0.16-km segments), and only 18% of roads with adjacent clearcuts harvested in the 1950's (n = 31 0.16-km segments) (Figure 110). On road segments with adjacent clearcuts harvested in the 1950's, *C. vulgare* decreased more on roads between 900 m and 1200 m, as opposed to roads below 900 m. On road segments with adjacent clearcuts harvested after 1960, or not clearcut at all, *C. vulgare* decreased 29% on roads with mean annual precipitation below 3200 mm/year (n = 134 0.16- km segments), and demonstrated no decrease on roads with mean annual precipitation above 3200 mm/year. *C. vulgare* also decreased on 41% on low use roads (n = 43 0.16-km segments), and only 27% on medium or high use roads (n = 96 0.16-km segments). On the medium or high use roads, *C. vulgare* decreased more on road segments with high or medium-high canopy cover as opposed to those with medium, medium-low, low, or very low canopy cover. Overall, *C. vulgare* was most likely to decrease on road segments with adjacent clearcuts harvested after 1960, or not clearcut at all, where mean annual precipitation is below 3200 mm/year, road use is low, and the road segment is not within 250 m of a rain gage.

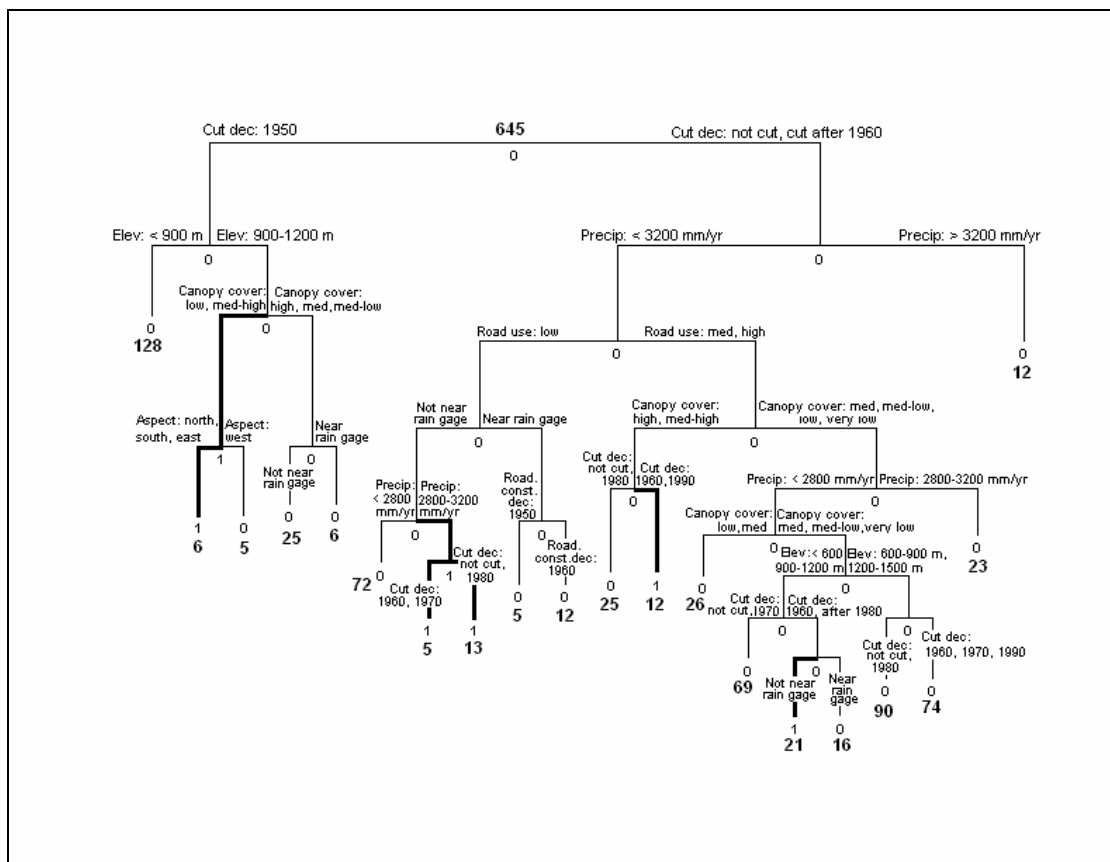

Figure 110. CART tree for the 11-year decrease of *C. vulgare*. Misclassification error rate of 22.6%.

Decrease of *C. scoparius*

The pruned CART tree for the 11-year decrease of *C. scoparius* on road segments in the H.J. Andrews Forest contained seven explanatory variables: decade of road construction, mean annual precipitation, elevation, level of road use, aspect, canopy cover, and decade of creation of the clearcut unit adjacent to the road (Figure 111). The pruned CART tree contained 13 terminal nodes and a misclassification rate of 2.5%. The most important predictor of 11-year decrease of *C. scoparius* was decade of road construction. *C. scoparius* decreased on 9% of roads built in the 1940's, 1970's or 1980's ($n = 4$ 0.16-km segments), and only 2% of roads built in the 1950's or 1960's ($n = 12$ 0.16-km segments) (Figure 111). On roads built in the

1950's or 1960's, *C. scoparius* decreased 2% on roads with mean annual precipitation below 2800 mm/year (n = 10 0.16-km segments), and demonstrated no decrease on roads with mean annual precipitation above 2800 mm/year. *C. scoparius* decreased 4% on roads with north or east facing aspects (n = 7 0.16-km segments), and only 1% on roads with south or west facing aspects (n = 4 0.16 km segments). On road segments with north or east facing slopes, *C. scoparius* demonstrated no decrease on segments adjacent to a clearcut unit harvested after 1980 or not clearcut at all, while on road segments with south or west facing slopes, *C. scoparius* demonstrated no decrease on segments adjacent to a clearcut unit harvested in the 1950's, 1970's, or 1990's. Overall, *C. scoparius* was most likely to decrease on road segments constructed in the 1940's, 1970's, or 1980's, where canopy cover is classified as medium or medium-low.

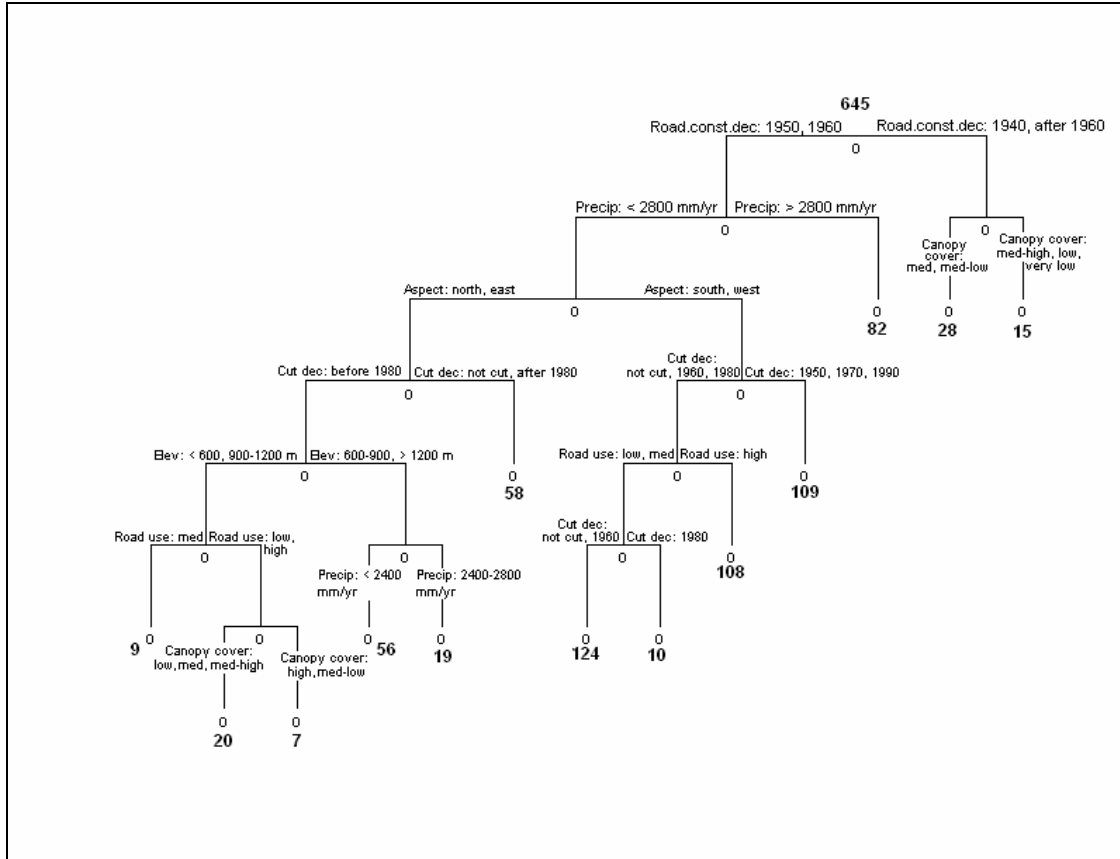

Figure 111. CART tree for the 11-year decrease of *C. scoparius*. Misclassification error rate of 2.5%.

Decrease of *S. jacobaea*

The pruned CART tree for the 11-year decrease of *S. jacobaea* on road segments in the H.J. Andrews Forest contained five explanatory variables: elevation, canopy cover, decade of creation of the clearcut adjacent to the road, level of road use, and aspect (Figure 112). The pruned CART tree contained 14 terminal nodes and a misclassification error rate of 12.2%. The most important predictor of 11-year decrease of *S. jacobaea* was elevation. *S. jacobaea* decreased on 18% of roads below 900 m (n = 75 0.16-km segments), and only 3% of roads above 900 m (n = 7 0.16-km segments) (Figure 112). On roads above 900 m, *S. jacobaea* demonstrated no decrease on road segments classified as medium-low, low, or very low canopy cover.

On roads below 900 m, *S. jacobaea* demonstrated a 15% decrease on roads between 600 m and 900 m ($n = 45$ 0.16-km segments), and a 27% decrease on roads below 600 m ($n = 31$ 0.16-km segments). On roads between 600 and 900 m, *S. jacobaea* did not decrease on east facing roads, and did not decrease on road segments classified as low or very low canopy cover. Overall, *S. jacobaea* was most likely to decrease on road segments below 600 m, on road segments classified as medium-low canopy cover.

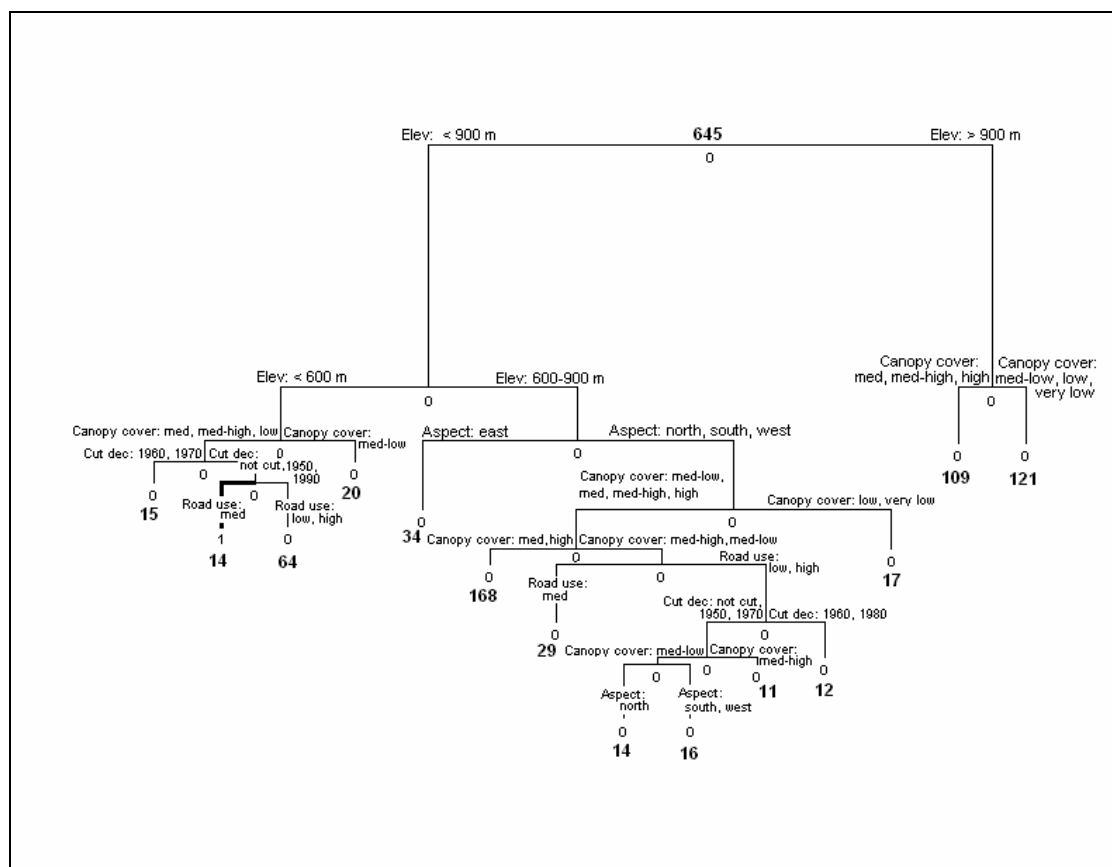

Figure 112. CART tree for the 11-year decrease of *S. jacobaea*. Misclassification error rate of 12.3%.

Decrease of *C. arvensis*

The pruned CART tree for the 11-year decrease of *C. arvensis* on road segments in the H.J. Andrews Forest contained eight explanatory variables: canopy

cover, proximity to rain gages, elevation, mean annual precipitation, aspect, level of road use, decade of creation of the adjacent clearcut unit, and decade of road construction (Figure 113). The pruned CART tree contained 30 terminal nodes and a misclassification error rate of 8.7%. The most important predictor of the 11-year decrease in *C. arvensis* was roadside canopy cover. *C. arvensis* decreased on 18% of road segments classified as medium-high canopy cover (n = 17 0.16-km segments), and only 8% of road segments classified as high, medium, medium-low, low, or very low canopy cover (n = 44 0.16-km segments) (Figure 113). On high, medium, medium-low, low, or very low canopy cover segments, *C. arvensis* decreased on 9% of road segments below 900 m or above 1200 m (n = 38 0.16-km segments), but only on 4% of road segments between 900 and 1200 m (n = 5 0.16-km segments). On roads below 900 m or above 1200 m, *C. arvensis* demonstrated the most decrease on road segments adjacent to clearcuts harvested in the 1960's, 1980's or not harvested at all, and no decrease was demonstrated on road segments with canopy cover classified as high.

On road segments classified as medium-high (n = 17 0.16-km segments), *C. arvensis* decreased on 40% of road segments within 250 m of a rain gage (n = 6 0.16-km segments), but only 14% of road segments not within 250 m of a rain gage (n = 11 0.16-km segments). Overall, *C. arvensis* was most likely to decrease on road segments that were classified as medium-high canopy cover, within 250 m of a rain gage, and at elevations below 600 m or between 900 and 1200 m.

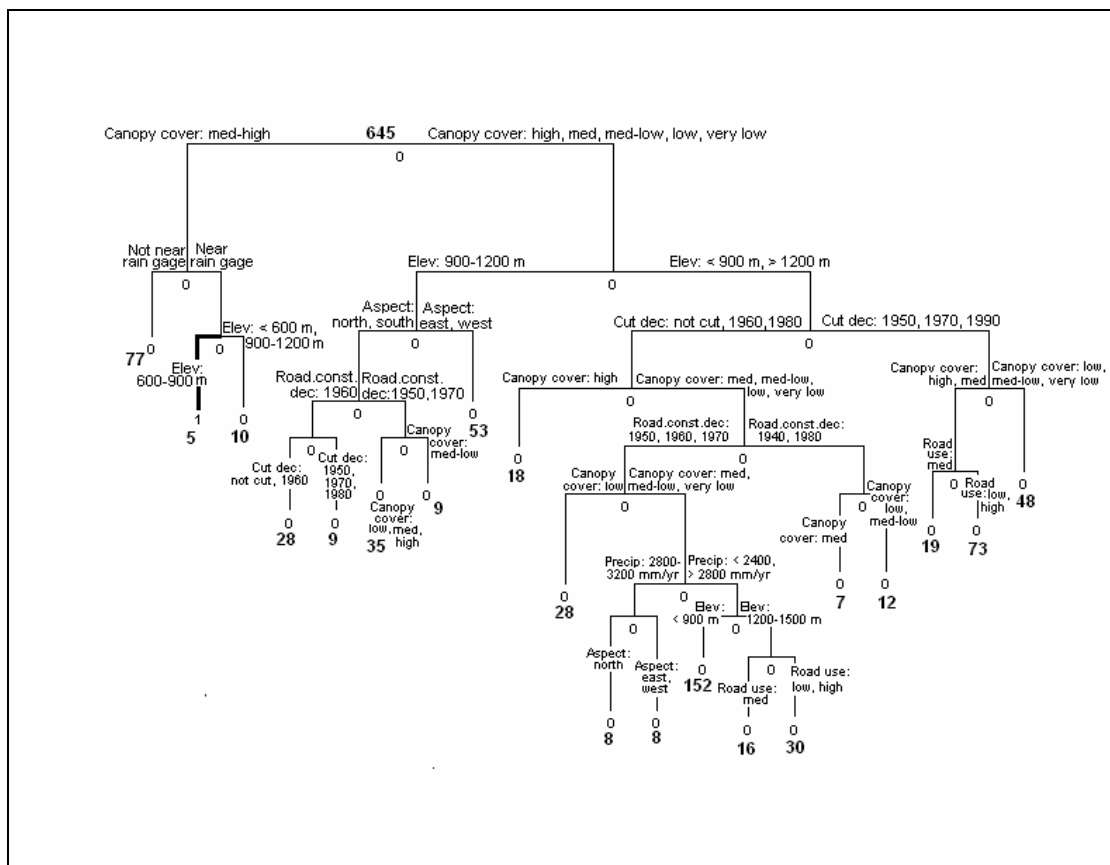

Figure 113. CART tree for the 11-year decrease of *C. arvensis*. Misclassification error rate of 8.7%.

Decrease of *R. discolor*

The pruned CART tree for 11-year decrease of *R. discolor* on road segments in the H. J. Andrews Forest contained four explanatory variables: decade of creation of the clearcut adjacent to the road, road use, decade of road construction, and aspect (Figure 114). The pruned CART tree contained 5 terminal nodes and a misclassification error rate of 0.1%. The most important predictor of 11-year decrease of *R. discolor* was decade of creation of the clearcut adjacent to the road. *R. discolor* decreased on 1% of road segments with clearcuts adjacent to the road harvested in the 1960's ($n = 1$ 0.16-km segments), and demonstrated no decrease on road segments

adjacent to clearcuts harvested in any other decade, or not harvested at all (Figure 114). *R. discolor* decreased on 2% of high-use roads (n = 1 0.16-km segment), and demonstrated no decrease on low or medium use roads. Overall, *R. discolor* decreased on road segments with adjacent clearcuts harvested in the 1960's, classified as high-use, built in the 1950's, and on south-facing aspects.

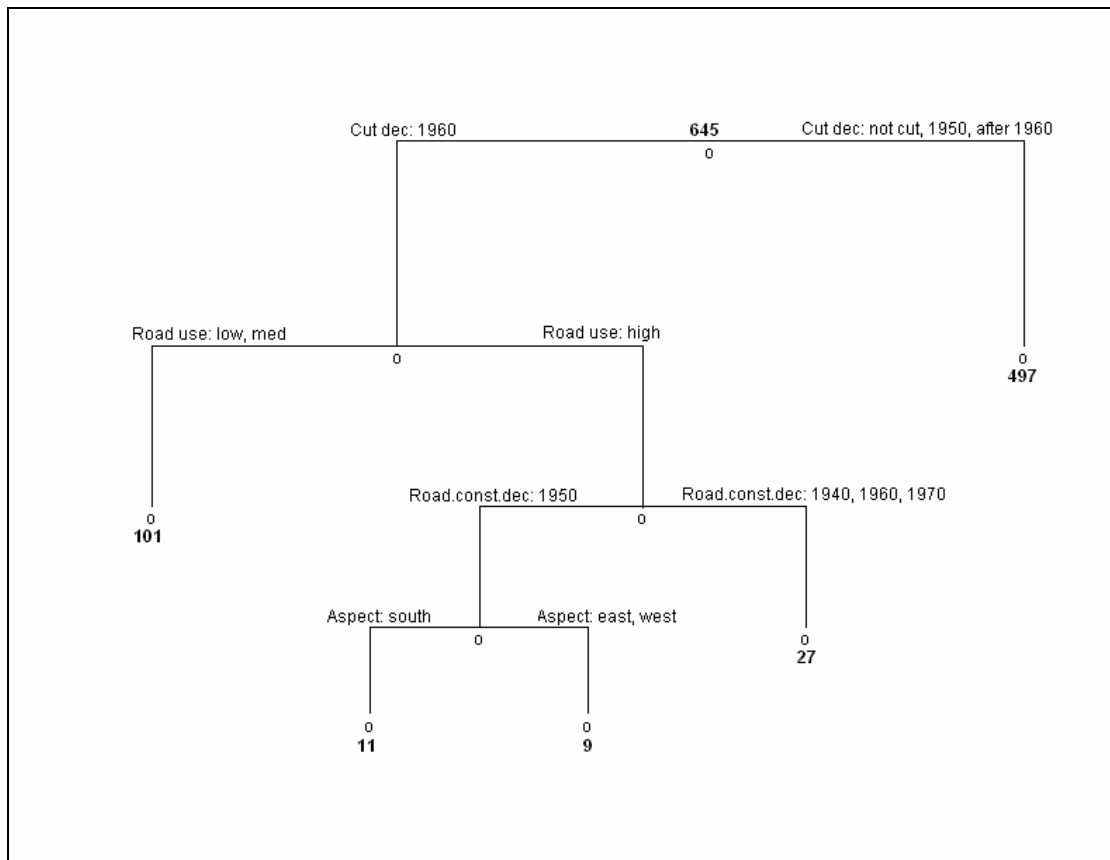

Figure 114. CART tree for the 11-year decrease of *R. discolor*. Misclassification error rate of 0.1%.

Summary of CART Results

CART analysis revealed the importance of various landscape factors and their associations with exotic species presence/absence in 2005, increase from 1994 to 2005, and decrease from 1994 to 2005. The two most significant explanatory landscape factors associated with exotic species occurrence, and which categories of

these variables were the best predictors of presence, increase, or decrease of exotic plants on the road network was summarized (Tables 9-11). To simplify the analysis, elevation was described as low (< 600 m), medium (600-900 m), medium-high (900-1200 m), or high (> 1200 m). Mean annual precipitation was also described as low (< 2400 mm/yr), medium (2400-2800 mm/yr), medium-high (2800-3200 mm/yr), or high (> 3200 mm/yr) (Tables 9-11).

Table 9. Summary of landscape factors associated with presence of exotic plants in 2005. Two most significant predictors from CART analysis listed.

Species	Landscape Factor							
	<u>Elevation</u>	<u>Aspect</u>	<u>Decade of Road Const.</u>	<u>Decade of Adjacent Clearcut</u>	<u>Canopy Cover</u>	<u>Mean Annual Precip</u>	<u>Road Traffic</u>	<u>Proximity to Rain Gages</u>
<i>H. perforatum</i>	med, med-high (1)			not cut, 1950s, 1970s, 1990s (2)				
<i>C. leucanthemum</i>	low, med, med-high (2)				med, med-high, high (1)			
<i>L. muralis</i>			before 1960 (1)				med, high (2)	
<i>C. vulgare</i>					low, med-low, med, med-high (2)	low (1)		
<i>S. jacobaea</i>		north, west (2)			med, med-high, high (1)			
<i>C. scoparius</i>	low, med (1)				very low, low, med-low (2)			
<i>C. arvense</i>			before 1960, 1970s (1)			low, med-high (2)		
<i>B. sylvaticum</i>		north (2)	1940s (1)					
<i>D. purpurea</i>	low, med (1)	north, east, west (2)						
<i>R. discolor</i>	low, med (1)							near rain gage (2)
<i>C. maculosa</i>	med-high (2)			after 1980 (1)				

Elevation was most often selected as the best predictor of the presence of exotic species in 2005 (Table 9). For four species, *H. perforatum*, *C. scoparius*, *D. purpurea*, and *R. discolor*, elevation was the best predictor, and for two species, *C. leucanthemum* and *C. maculosa*, elevation was the second best predictor. Presence of *H. perforatum*, *C. leucanthemum*, and *C. maculosa* were associated with higher elevations (between 600-1200 m, below 1200 m, and between 900-1200 m, respectively), while *C. scoparius*, *D. purpurea*, and *R. discolor* were closely associated with low elevations below 900 m. Elevation was a minor predictor of *C. vulgare* (below 900 m) and *S. jacobaea* (between 900 and 1200 m), and was not a significant predictor in the CART trees constructed for *B. sylvaticum* or *C. arvense* (Table 9).

Canopy cover was the second most often selected predictor of the presence of exotic species in 2005 (Table 9). For two species, *C. leucanthemum* and *S. jacobaea*, canopy cover was selected as the first explanatory variable, and for two species, *C. vulgare* and *C. scoparius*, canopy cover was the second best explanatory variable. Presence of *C. leucanthemum* and *S. jacobaea* was associated with road segments exposed to medium to high degrees of canopy cover, while *C. vulgare* was associated with a medium range of canopy cover (from low to medium-high), and *C. scoparius* was most likely found on medium-low to very low canopy cover segments. Canopy cover was a minor predictor of *B. sylvaticum* (medium to medium-high), *D. purpurea* (medium-low to medium), and *L. muralis* (medium to medium-high), and was not a significant predictor in the CART trees constructed for *H. perforatum*, *C. arvense*, *C. maculosa*, or *R. discolor*.

Other important landscape factors associated with exotic species presence in 2005 included decade of road construction and aspect. Decade of road construction was the best predictor of presence of *L. muralis* (roads built before 1960), *C. arvensis* (before 1960 or during the 1970's), and *B. sylvaticum* (1940's). Aspect was the second best predictor of *S. jacobaea* (north or west-facing aspects), *B. sylvaticum* (north-facing aspects), and *D. purpurea* (north, east, or south-facing aspects). The most important explanatory variable for the presence of *C. maculosa* in 2005 was decade of creation of the adjacent clearcut (after 1980). The most important explanatory variable for the presence of *C. vulgare* in 2005 was mean annual precipitation (low level, < 2400 mm/yr) (Table 9).

Table 10. Summary of landscape factors associated with increase of exotic plants from 1994 to 2005. Two most significant predictors from CART analysis listed.

Species	Landscape Factor							
	<u>Elevation</u>	<u>Aspect</u>	<u>Decade of Road Const.</u>	<u>Decade of Adjacent Clearcut</u>	<u>Canopy Cover</u>	<u>Mean Annual Precip</u>	<u>Road Traffic</u>	<u>Proximity to Rain Gages</u>
<i>H. perforatum</i>	high (1)						low (2)	
<i>C. leucanthemum</i>			after 1960 (1)		very low, low, med-low, med (2)			
<i>C. vulgare</i>				not cut, 1950s, after 1980s (2)			med, high (1)	
<i>S. jacobaea</i>	med, med-high (1)	north, west (2)						
<i>C. scoparius</i>	low, med (1)				very low, low, med-low, med-high (2)			
<i>C. arvense</i>			before 1960, 1970s (1)		low, med-low (2)			
<i>D. purpurea</i>	low, med (1)	north, east, west (2)						
<i>R. discolor</i>	low, med (1)					med, high (2)		

Elevation was most often selected as the best predictor of the increase in exotic species from 1994 to 2005 (Table 10). Elevation was selected as the first explanatory variable for the increase of *H. perforatum*, *S. jacobaea*, *C. scoparius*, *D. purpurea* and *R. discolor*. Increase of *H. perforatum* occurred most often at high elevations (> 1200 m), increase of *S. jacobaea* occurred most often at medium to medium-high elevations (600-1200 m), and increase of *C. scoparius*, *D. purpurea*, and *R. discolor* were closely associated with low elevations (< 900 m). Elevation was a minor predictor of the

increase of *C. leucanthemum* (600-900 m), *C. arvensis* (< 600 m or > 900 m), and *C. vulgare* (< 600 m) (Table 10).

Canopy cover and road traffic were the second most often selected predictors of the increase in exotic species from 1994 to 2005. Canopy cover was selected as the second best predictor of the increase of *C. leucanthemum*, *C. arvensis*, and *C. scoparius* (Table 10). Increase of *C. leucanthemum* was associated with very low to medium canopy cover, increase of *C. arvensis* was associated with low to medium-low canopy cover, and increase of *C. scoparius* was associated with very low to medium or medium-high canopy cover. Canopy cover was a minor predictor of the increase of *D. purpurea* (medium-low to medium), *H. perforatum* (very low to medium), *R. discolor* (low or medium), and *S. jacobaea* (medium-low or med), and was not a predictor of the increase of *C. vulgare*.

Road traffic was selected as the best predictor of the increase of *C. vulgare*, and the second best predictor of the increase of *R. discolor* and *H. perforatum* (Table 10). Increase of *C. vulgare* and *R. discolor* was associated with medium and high use roads, while increase of *H. perforatum* was associated with low use roads. Road traffic was a minor predictor of the increase of *C. arvensis* (medium and high use), *D. purpurea* (low and high use), and *C. leucanthemum* (medium and high use), and was not a significant predictor for the increase of *C. scoparius* or *S. jacobaea*.

Other important landscape factors associated with increase in presence of exotic species from 1994 to 2005 include decade of road construction and aspect. Decade of road construction was the best predictor of the increase of *C. arvensis* (before the 1960's or during the 1970's) and the best predictor of the increase of *C.*

leucanthemum (after 1960). Aspect was the second best predictor for the increase of *D. purpurea* (north, east or west-facing aspects) and the second best predictor for the increase of *S. jacobaea* (north or west-facing aspects) (Table 10).

Table 11. Summary of landscape factors associated with decrease of exotic plants from 1994 to 2005. Two most significant predictors from CART analysis listed.

Species	Landscape Factor							
	<u>Elevation</u>	<u>Aspect</u>	<u>Decade of Road Const.</u>	<u>Decade of Adjacent Clearcut</u>	<u>Canopy Cover</u>	<u>Mean Annual Precip</u>	<u>Road Traffic</u>	<u>Proximity to Gages</u> near stream gage (1)
<i>H. perforatum</i>				1960s (2)				
<i>C. leucanthemum</i>				1970s (2)	very low (1)			
<i>C. vulgare</i>				not cut, after 1960 (1)		low, med, med-high (2)		
<i>S. jacobaea</i>	low, med (1); low (2)							
<i>C. scoparius</i>			1940s, after 1970 (1)		med, med-low (2)			
<i>C. arvense</i>						med-high (1)		near rain gage (2)

Decade of the creation of the adjacent clearcut was most often selected as the best predictor of the decrease in exotic species from 1994 to 2005 (Table 11). Decade of the creation of the adjacent clearcut was selected as the first explanatory variable for the decrease of *R. discolor* and *C. vulgare*, and the second explanatory variable for the decrease of *H. perforatum* and *C. leucanthemum* (Table 11). The decrease of *R. discolor* and *H. perforatum* was associated with clearcuts harvested in the 1960's, the decrease of *C. vulgare* was associated with clearcuts harvested after 1960 or not cut at

all, and the decrease of *C. leucanthemum* was associated with clearcuts harvested in the 1970's. Decade of creation of the adjacent clearcut was a minor predictor in the decrease of *C. arvensis* (not cut at all, or cut in the 1960's or 1980's) and *C. scoparius* (not cut at all, or cut in the 1960's or 1980's).

Other important landscape factors associated with decrease include elevation, canopy cover, and mean annual precipitation. Elevation was selected as the first and second explanatory variables for the decrease of *S. jacobaea* (below 900 m and below 600 m) (Table 11). Canopy cover was selected as the first explanatory variable for the decrease of *C. leucanthemum* (very low), and the second explanatory variable for the decrease of *C. scoparius* (medium-low to medium). Mean annual precipitation was selected as the first explanatory variable for the decrease of *C. arvensis* (medium-high level, 2800-3200 mm/yr), and the second explanatory variable for the decrease of *C. vulgare* (below medium-high level, < 3200 mm/yr). The best explanatory variable for the decrease of *H. perforatum* was proximity to stream gages (most decrease within 250 m of a stream gage), while the best explanatory variable for the decrease in *C. scoparius* was decade of road construction (1940's or after 1970's) (Table 11).

Correlations Between Landscape Factors

In order to investigate possible correlations between the ten landscape factors at the H.J. Andrews Forest analyzed in this study (elevation, mean annual precipitation, aspect, decade of creation of adjacent clearcut, decade of road construction, level of road use, roadside canopy cover, and proximity to stream, thermal, and rain gages), a qualitative evaluation of association between categorical

variables based on co-occurrences was completed. Table 12 lists the proportions of the total road network (645 0.16-km segments) in which two variables fall into the same combinations of categories, expressed as percents. For example, 17.7% of the 0.16-km segments surveyed on the H.J. Andrews Forest road network are classified as *both* < 2400 mm/year in mean annual precipitation, as well as existing below 600 m in elevation (Table 12).

The lowest precipitation category, in which mean annual precipitation is below 2400 mm/year, demonstrated notable associations (based on co-occurrences) with: segments between 600 m and 900 m in elevation (40.2% of the network), on roads constructed in 1950 (44.5% of the network), where roadside canopy cover is estimated as medium (37.4% of the network), and where road use is classified as high (37.5% of the network) (Table 12). Other associations involved proximity to monitoring gages. Segments of the road network *not* within 250 m of a stream gage co-occurred considerably with: elevations between 600 m and 900 m (45.9% of the road network), mean annual precipitation < 2400 mm/year (63.1% of the network), roads built in the 1950's (52.7% of the network) or 1960's (36.3% of the network), high road use (39.2% of the network), and medium roadside canopy cover (45% of the network). Similarly, segments of the road network *not* within 250 m of either thermal or rain gages demonstrated close associations between these same categorical variables (Table 12). Finally, a majority of the road network was not within 250 m of: either a stream or a rain gage (81.6% of the network), a stream or a thermal gage (82.8% of the network), or a rain or a thermal gage (73.6% of the network) (Table 12).

In order to provide a statistical comparison of the 10 categorical landscape variables, a cross-tabulation analysis was conducted (Table 13). The chi-square statistic was used to test for independence of categorical variables and to measure the degree of association. In cases where the expected frequency of 0.16-km segments in any one category was below 5, categories were collapsed, degrees of freedom were adjusted, and chi-square values were calculated by hand.

Table 13. Results of cross-tabulation test for independence of landscape variables.

Variable 1	Variable 2	Chi-Square	df	P-value
Elevation	Precipitation	334	6	< 0.0001*
Elevation	Aspect	15.7	9	0.07
Elevation	Decade of Adjacent Clearcut	74.2	6	< 0.0001*
Elevation	Decade of Road Construction	65.6	6	< 0.0001*
Elevation	Road Use	87	6	< 0.0001*
Elevation	Proximity to Stream Gages	32.2	2	< 0.0001*
Elevation	Proximity to Thermal Gages	12	3	0.007*
Elevation	Proximity to Rain Gages	34.6	3	< 0.0001*
Elevation	Canopy Cover	121.6	9	< 0.0001*
Precipitation	Aspect	80	6	< 0.0001*
Precipitation	Decade of Adjacent Clearcut	6	6	0.42
Precipitation	Decade of Road Construction	170	4	< 0.0001*
Precipitation	Road Use	153	4	< 0.0001*
Precipitation	Proximity to Stream Gages	17	2	0.0002*
Precipitation	Proximity to Thermal Gages	14.9	2	0.0006*
Precipitation	Proximity to Rain Gages	2.8	2	0.247
Precipitation	Canopy Cover	119.1	6	< 0.0001*
Aspect	Decade of Adjacent Clearcut	32.3	12	0.0012*
Aspect	Decade of Road Construction	36	6	< 0.0001*
Aspect	Road Use	46.8	6	< 0.0001*
Aspect	Proximity to Stream Gages	5.9	2	0.0523
Aspect	Proximity to Thermal Gages	9.3	3	0.26

Table 13 continued. Results of cross-tabulation test for independence of landscape variables.

Variable 1	Variable 2	Chi-Square	df	P-value
Decade of Road Construction	Proximity to Thermal Gages	3.6	2	0.165
Decade of Road Construction	Proximity to Rain Gages	4.8	2	0.091
Decade of Road Construction	Canopy Cover	42.8	6	< 0.0001*
Road Use	Proximity to Stream Gages	4.2	2	0.12
Road Use	Proximity to Thermal Gages	18.9	2	< 0.0001*
Road Use	Proximity to Rain Gages	0.5	2	0.76
Road Use	Canopy Cover	80.4	8	< 0.0001*
Proximity to Stream Gages	Proximity to Thermal Gages	3.2	1	0.08
Proximity to Stream Gages	Proximity to Rain Gages	71.3	1	< 0.0001*
Proximity to Stream Gages	Canopy Cover	5.2	6	0.51
Proximity to Thermal Gages	Proximity to Rain Gages	6.2	1	0.01*
Proximity to Thermal Gages	Canopy Cover	6	4	0.1991
Proximity to Rain Gages	Canopy Cover	0.97	3	0.809

***P-value less than 0.05; variables correlated**

The following pairs of variables were found to be independent of each other on the H.J. Andrews Forest road network: elevation and aspect (p-value of 0.07), mean annual precipitation and decade of creation of the adjacent clearcut (p-value of 0.42), mean annual precipitation and proximity to rain gages (p-value of 0.247), aspect and proximity to stream (p-value of 0.052), thermal (p-value of 0.26), and rain (p-value of 0.74) gages, decade of road construction and proximity to stream (p-value of 0.064),

thermal (p-value of 0.165) and rain (p-value of 0.091) gages, road use and proximity to stream (p-value of 0.12) and rain (p-value of 0.76) gages, proximity to stream and proximity to thermal gages (p-value of 0.08), and canopy cover and proximity to stream (p-value of 0.51), thermal (p-value of 0.199), and rain gages (p-value of 0.81) (Table 13). Noteworthy correlations, where the probability of independence is less than 0.0001, include: proximity to stream and rain gages, road use and canopy cover, road use and proximity to thermal gages, decade of road construction and canopy cover, decade of road construction and road use, decade of creation of the adjacent clearcut and road use, aspect and canopy cover, aspect and road use, aspect and decade of road construction, mean annual precipitation and canopy cover, mean annual precipitation and road use, mean annual precipitation and decade of road construction, mean annual precipitation and aspect, elevation and canopy cover, elevation and proximity to rain and stream gages, elevation and road use, elevation and decade of road construction, elevation and decade of creation of the adjacent clearcut, and elevation and mean annual precipitation (Table 13).

Evaluation of Exotic Species Diversity

In 1994, the total number of exotic plants per 0.16-km road segment ranged from zero to six, out of the eight included in the target survey (Figure 115). In particular, the first kilometer of road 1506, the first kilometer of road 1507, and the mid section of road 320 had the most diversity of exotic plants, generally above 5 per 0.16-km road segment (Figure 115).

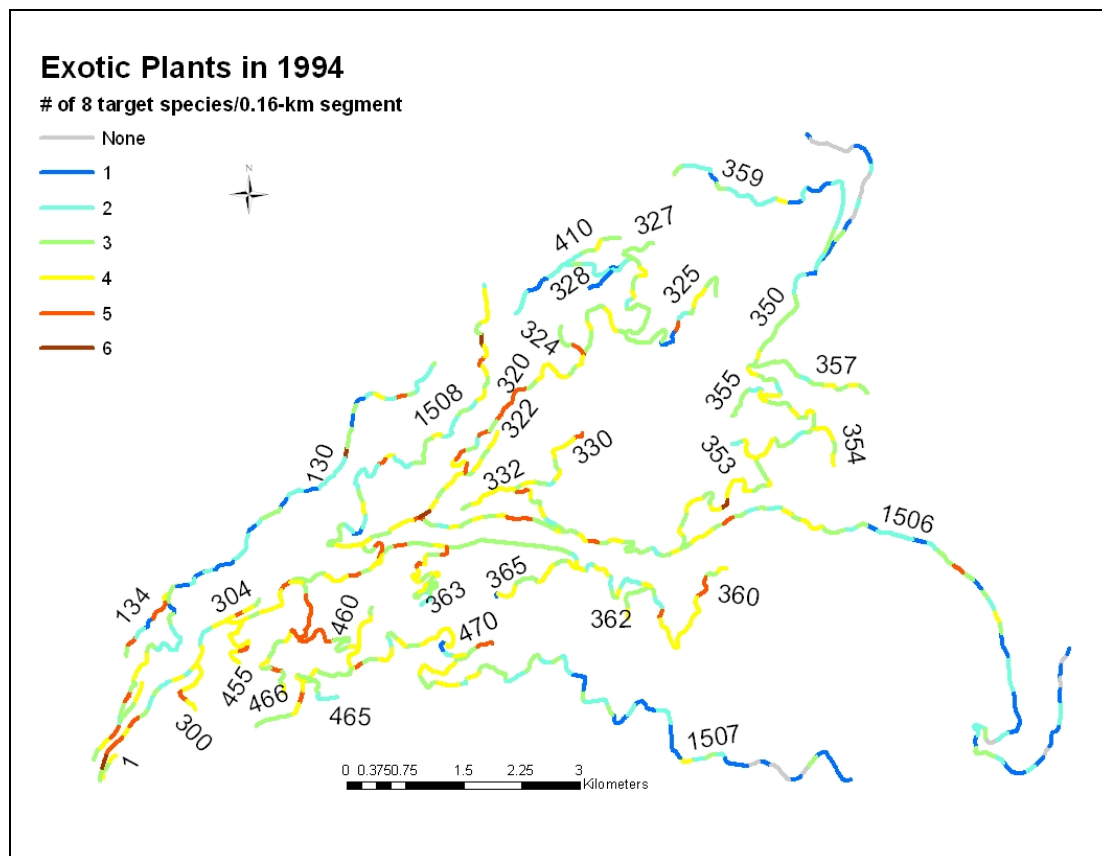

Figure 115. Total number of exotic species per 0.16-km segment at the H.J. Andrews Forest in 1994.

In 2005, the total number of exotic plants per 0.16-km road segment ranged from zero to six, out of the eight target species sampled in 1994 (Figure 116). The 2005 diversity map (Figure 116) does not include *B. sylvaticum*, *C. maculosa*, or *L. muralis*, which were not sampled in 1994. These three species, while contributing to exotic diversity in 2005, were not included in the 2005 map so meaningful comparisons of changes in landscape pattern can be made between the years. However, all 11 species sampled in 2005 were included in the measure of the change in diversity in the regression tree model. Locations of high exotic plant diversity in 2005 include the end of road 1508, and the middle and far end of road 360, which

often held between five and six exotic plant species per 0.16-km road segment (Figure 116).

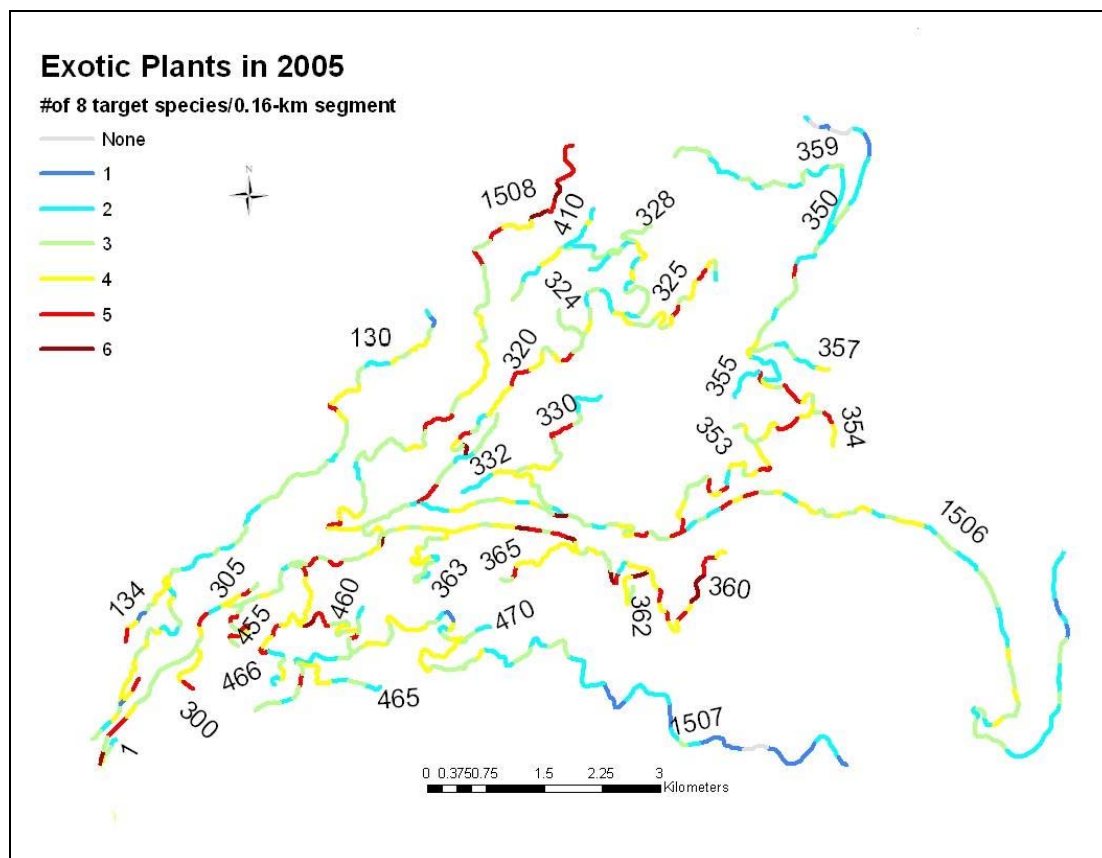

Figure 116. Total number of exotic species (out of eight sampled in 1994) per 0.16-km segment at the H.J. Andrews Forest in 2005.

The 1994 and 2005 maps of the total number of exotic species per road segment show that higher numbers of exotics persist at the older, center of the road network, on the beginning portions of roads 1506, 320, 1507 and 130, while lower numbers of exotics are present at the higher elevation peripheries of the network on the end portions of these roads. Increase in diversity from 1994 to 2005 is evident at upper elevations on roads 1508, 1506, 410, and 130, but not on road 1507 (Figures 115 and 116).

The pruned CART tree for the total diversity of exotic species on road segments in 2005 contained four explanatory variables: elevation, road use, road construction decade, and canopy cover (Figure 117). The most important predictor of diversity on the road network was elevation (Figure 117). At elevations greater than 1200 m, the predicted number of exotic species per road segment is 4.0 (n = 80 0.16-km segments), while at elevations less than 1200 m, the predicted number of exotic species per road segment is 7.6 (n = 565 0.16-km segments). The regression tree further selected elevation as the next best predictor of diversity on the road network, and predicted a total of 6.5 exotic species per road segment at elevations between 900 and 1200 m (n = 150 0.16-km segments), compared to a predicted total of 8.0 exotic species per road segment at elevations less than 900 m (n = 415 0.16-km segments). (Figure 117). The regression tree also predicted higher exotic diversity on road segments classified as high or low use, and on roads constructed in the 1940s and 1950s. Overall, diversity of exotic species on the road network is highest at elevations below 900 m.

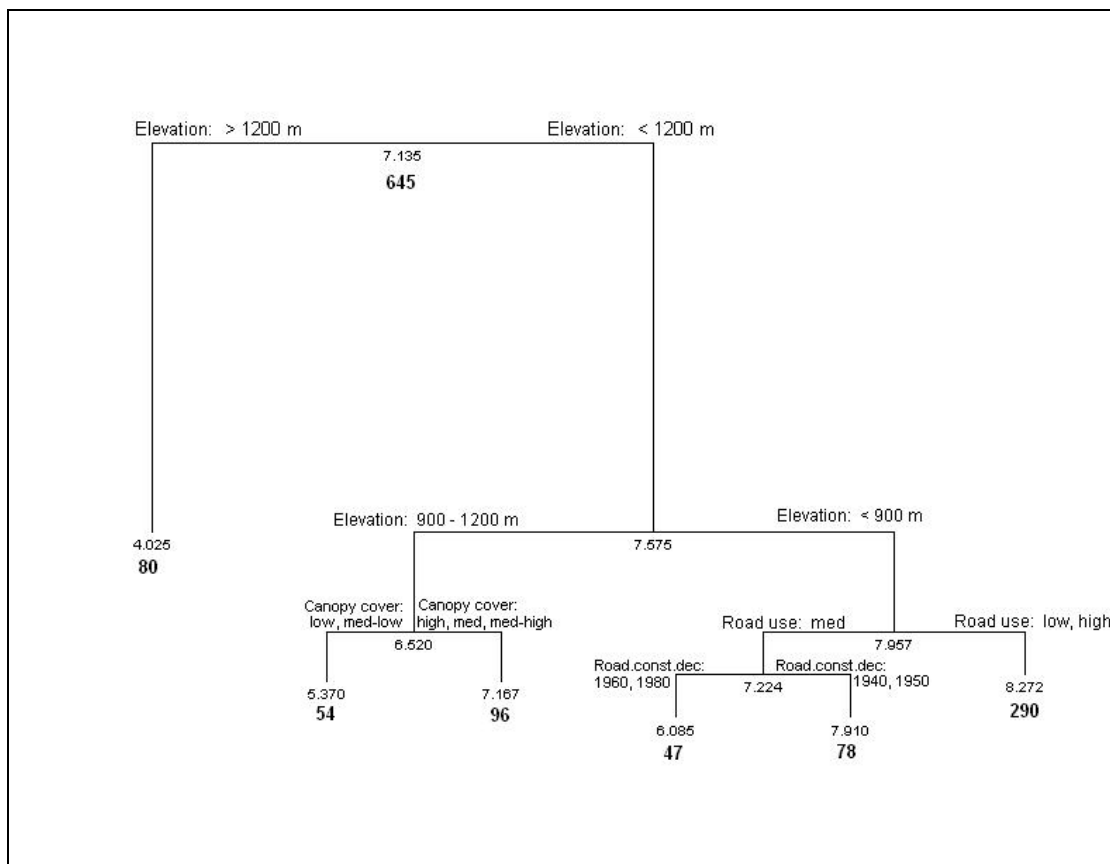

Figure 117. CART tree for exotic species diversity on the road network of the H.J. Andrews Forest in 2005. Residual mean deviance of 2.9.

The pruned CART tree for the change in diversity of exotic species on road segments from 1994 to 2005 contained seven explanatory variables: road use, canopy cover, aspect, decade of road construction, decade of creation of the adjacent clearcut, elevation, and proximity to thermal gages (Figure 118). The most important predictor for the change in diversity of exotic species on the road network from 1994 to 2005 was road use. On road segments classified as low, the regression tree predicted an increase of 0.84 species per road segment from 1994 to 2005 ($n = 164$ 0.16-km segments), while on road segments classified as medium or high, the regression tree predicted an increase of 1.23 species per road segment ($n = 481$ 0.16-km segments). The next best predictor of change in diversity of exotic species from 1994 to 2005 was

decade of creation of the adjacent clearcut. On road segments adjacent to areas on the network that have not been cut, or were cut before 1970 or after 1980, the regression tree predicted an increase of 1.18 species per road segment ($n = 435$ 0.16-km segments), while on road segments adjacent to areas on the network cut in the 1970s, the regression tree predicted an increase of 1.70 species per road segment ($n = 46$ 0.16-km segments). The regression tree also predicted a greater increase in diversity on high-use roads, and roads constructed in the 1940s or 1970s, at elevations above 600 m, near thermal stations. Overall, increase in exotic plant diversity was greatest on medium or high-use roads adjacent to units that had been clearcut in the 1970s.

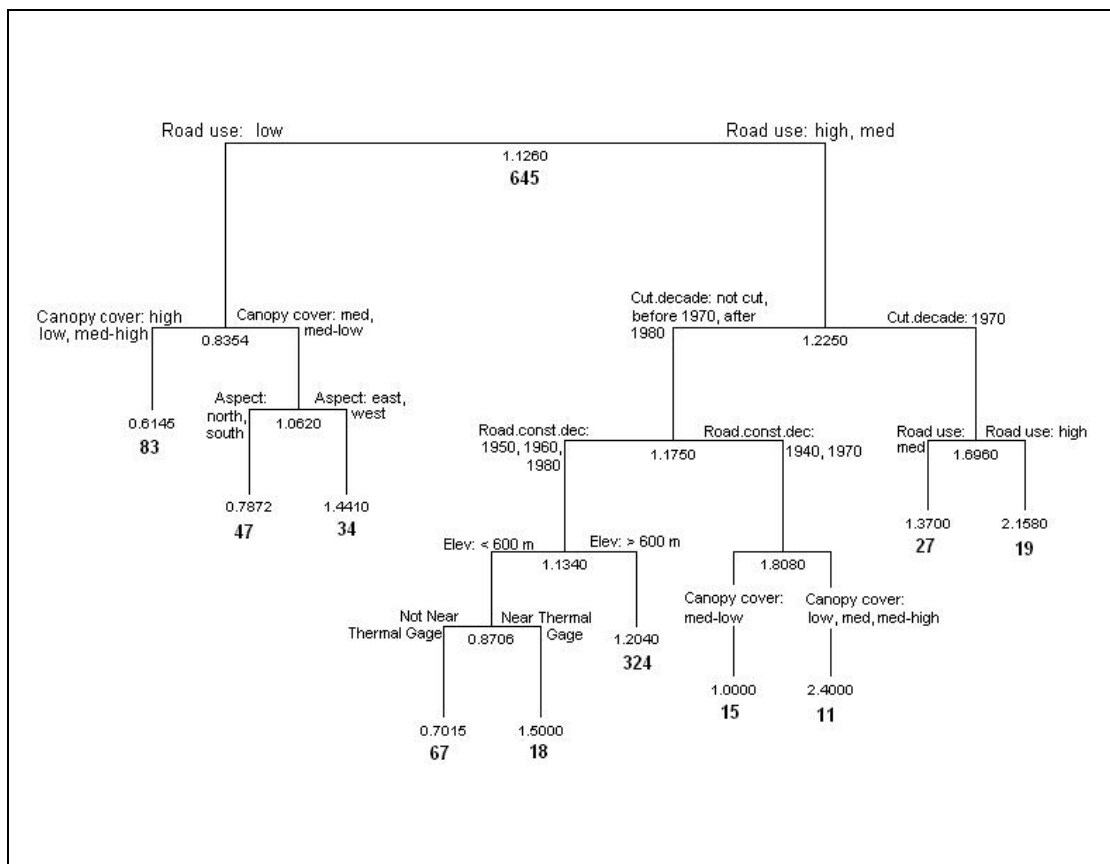

Figure 118. CART tree for change in exotic species diversity on the road network of the H.J. Andrews Forest from 1994 to 2005. Residual mean deviance of 1.38.

DISCUSSION

Spatial Distribution Patterns of Exotic Species in 2005

The majority of the H.J. Andrews Forest falls within Lane County, Oregon, from approximately 44° 12' 30" N north into Linn County, where the upper portion of the Lookout Creek basin extends over the county line to approximately 44° 17' 0" N. Historical records of exotic species exist for both Lane and Linn counties, and is available on-line in the INVADERS Database System (<http://invader.dbs.umt.edu/>), which contains county-level weed distribution records dating back as early as 1875 for five northwestern states: Oregon, Washington, Idaho, Wyoming, and Idaho (Rice 2006). Six-hundred and thirty-eight exotic species have been documented in the state of Oregon; 161 in Linn County and 247 in Lane County. Historical regional distribution information for the 11 species surveyed in this study is organized by the earliest date of record in the northwest (Table 14).

Table 14. Historical distribution information for the 11 target species sampled in 2005 (from INVADERS database). Rate of change in northwest from 1990 to 2005 was classified as low if increase in reporting counties was between 0 and 15%, medium if increase was between 15% and 30%, and high if increase was greater than 30%.

Percent of Counties in NW Reporting by 2005	Rate of Change in NW 1990-2005	First Reported in the Northwest			
		Before 1920		After 1920	
		First Reported in Linn and Lane County		First Reported in Linn and Lane County	
		Before 1920	1921 - 1950	1951 - 1990	After 1990
> 90%	high				<i>C. maculosa</i>
	med		<i>C. arvensis</i>		
	low				
51% - 90%	high				
	med		<i>C. leucanthemum</i>	<i>C. vulgare</i>	
	low		<i>H. perforatum</i>		
11% - 50%	high		<i>C. scoparius</i>	<i>S. jacobaea</i>	
	med				
	low		<i>D. purpurea</i>		
< 10 %	high				<i>L. muralis</i>
	med				<i>B. sylvaticum,</i> <i>R. discolor</i>

C. scoparius was the earliest of the 11 target species to be documented the northwest (1880), and although widely distributed at the H.J. Andrews, it is patchy on many roads, suggesting that environmental barriers limit its distribution. In the northwest by 2005, 29% of counties had reported presence of *C. scoparius* (Rice 2006). *C. scoparius* occurred along 20.6% of the road network in and around the H.J. Andrews in 2005, and ranked 6th in frequency of the species sampled, which compares well with the regional distribution (Table 3). Documentation of *C. scoparius* in the northwest has risen 30% since 1990, and *C. scoparius* increased 6.0% on the road network from 1994 to 2005 and ranked 3rd in percent of increase of the species sampled, again comparing well to the regional pattern of increase (Table 14).

C. scoparius was introduced (or at least documented) in the region the earliest of the 11 species sampled, especially in Linn County, where records of *C. scoparius* date back over 110 years. If time since introduction was the sole consideration of invasion success, it would be expected that *C. scoparius* would be the most widely distributed species on the road network. *C. scoparius* was widely distributed, occurring both on major roads as well as on remote stretches of the road network, including low-use roads such as 700 and 705 over the eastern ridge, and roads at the ends of the network such as 359 and 1506 (Figure 10). This indicates that *C. scoparius* may have been present in the vicinity of the H.J. Andrews for many decades. However, CART analysis revealed the *C. scoparius* was most often located at lower elevations (Figure 135), and evidence of patchiness on many roads from the standardized semivariogram (Figure 68) indicates that environmental barriers, such as

light availability or temperature conditions associated with elevation, may limit the distribution of *C. scoparius* in the H.J. Andrews Forest.

Once an exotic plant is introduced to a landscape, the area it occupies or its frequency per unit area increases over time. This expansion is often conceptualized as a logistic growth curve (Forcella and Harvey 1983, Forcella 1985, Groves 1986, Moody and Mack 1988, Pysek and Prach 1993, Cousins and Mortimer 1995, Luken and Thieret 1996, Radosevich *et. al.* 1997). Groves (1986) described this logistic curve as having three phases: (1) introduction, where propagules arrive at a site and may persist at low frequencies in a “lag phase”, (2) colonization, a period of rapid, active expansion, and (3) naturalization, a state of dynamic equilibrium with no net expansion, as the exotic species becomes incorporated into the resident flora (Figure 119). Possible ecological reasons for the termination of range expansion include the re-imposition of a dispersal barrier, or perhaps that the species has reached the limits of suitable new habitats (Cousons and Mortimer 1995).

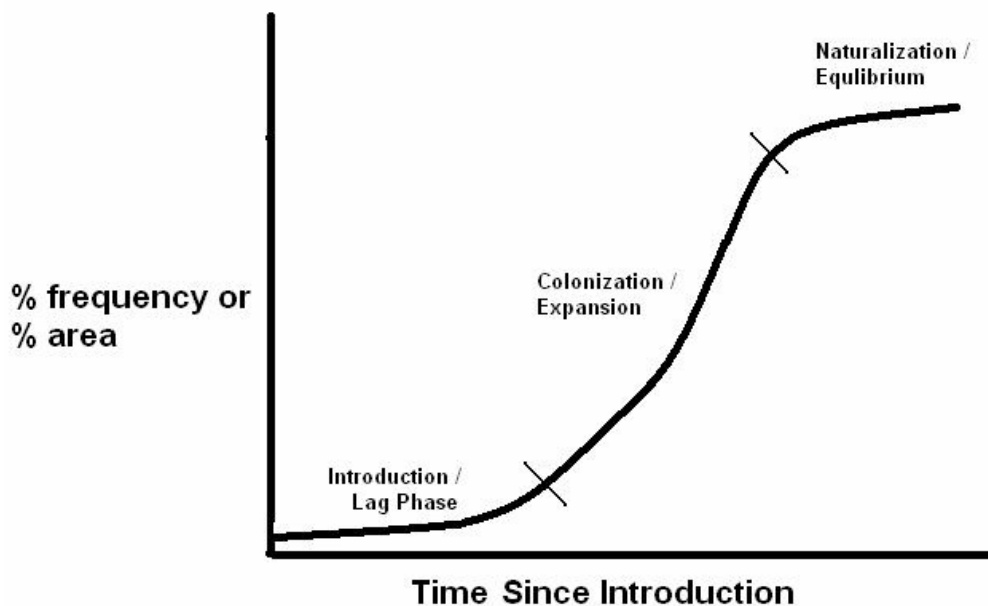

Figure 119. Conceptual model of plant invasion on a landscape over time.

Specific interactions between plant life history traits, the time period of invasion, and landscape factors will dictate the shape of this curve. For example, the same plant species may reach the equilibrium phase at different times in separate landscapes, because diverse landscapes will contain different physical and environmental barriers that this particular species may overcome easier in one location than in the other. Alternatively, two different plant species may reach the equilibrium phase at different times in the same landscape, due to different life history attributes like dispersal capabilities, or different tolerances for environmental barriers in that landscape.

Both *C. leucanthemum* and *H. perforatum* were documented in the northwest in the late 1880s, and are the two most frequent and most widely distributed species at the H.J. Andrews Forest, suggesting that they may have reached the equilibrium phase of invasion on the landscape.

In the northwest by 2005, 54% of counties had reported presence of *H. perforatum*, while 56% of counties had reported presence of *C. leucanthemum* (Rice 2006). *H. perforatum* occurred along 90.2% of the road network in and around the H.J. Andrews in 2005, and ranked first in frequency of the species sampled; *C. leucanthemum* occurred along 78.9% of the road network and ranked second in frequency of the species sampled (Table 3). Both *C. leucanthemum* and *H. perforatum* are more frequent at the H.J. Andrews than they are in the northwest, suggesting other areas of the northwest may contain some physical or climatic barriers to expansion of these species, or that habitat conditions in the western Cascades could be especially conducive to the spread of *C. leucanthemum* and *H. perforatum*.

Documentation of these species in the northwest has risen 25% for *C. leucanthemum* and 12% for *H. perforatum* since 1990 (Table 14). At the H.J. Andrews, *C. leucanthemum* increased 14.7% on the road network from 1994 to 2005 and ranked 1st in percent of increase of the species sampled; *H. perforatum* increased 5.8% on the road network from 1994 to 2005 and ranked 4th in percent of increase of the species sampled. Both *C. leucanthemum* and *H. perforatum* appear to be spreading faster at the H.J. Andrews in comparison to the regional increase. This further supports the notion that physical or climatic barriers to expansion do not exist for these species in the study area.

Both *C. leucanthemum* and *H. perforatum* were documented in Lane and Linn counties before 1920 (Table 14), and both were widely distributed on the road network in 2005, occurring on major roads as well as on remote stretches of the road network over the east ridge (Figures 6 and 7). This indicates that these species have been present in the vicinity of the H.J. Andrews for many decades. Spatial analysis revealed low to medium variability for *C. leucanthemum* on the roads at the H.J. Andrews (Table 5), and CART analysis associated the distribution of *H. perforatum* with medium and medium-high elevations (Table 10), suggesting these species may have approaching the equilibrium phase of invasion on the H.J. Andrews landscape (Figure 119). Neither *C. leucanthemum* nor *H. perforatum* are shade tolerant, and they do not grow in the dense forest understory, so their distributions are limited to the road network exclusively. Although there are a few locations yet to be colonized by these species on the Deer Creek Basin roads, by 2005 they have covered almost all of the

road network in and around the H.J. Andrews Forest and are approaching the limits of suitable new habitats.

C. arvensis was the most widespread exotic species in the northwest of the 11 target species sampled, but was not the most frequent on the H.J. Andrews Forest road network, suggesting that *C. arvensis* may behave differently in the steep, forested landscape of the western Cascades. In the northwest by 2005, 93% of counties had reported presence of *C. arvensis* (Rice 2006). *C. arvensis* occurred along only 11.7% of the road network in and around the H.J. Andrews in 2005, and ranked 7th in frequency of the species sampled (Table 3). Documentation of *C. arvensis* in the northwest has risen 27% since 1990 (Table 14), while *C. arvensis* actually decreased 1.2% on the road network from 1994 to 2005. The limited presence and decrease in frequency of *C. arvensis* over the 11-year period do not parallel the regional pattern of widespread distribution and significant increase of *C. arvensis* in the northwest since 1990.

C. arvensis was documented in Lane and Linn counties before 1920 (Table 14), but this species was randomly distributed on the H.J. Andrews Forest roads, while absence dominated on Hwy 126 east of the H.J. Andrews, and on the first few kilometers of roads 2654, 700, and 1506 over the east ridge (Figure 12). *C. arvensis* occurred on both major roads as well as on remote stretches of the road network, indicating that this species have been present in the vicinity of the H.J. Andrews for many decades.

The spatial pattern of *C. arvensis* occurrence on the network was unexpected. Patches were discontinuous and randomly located on 0.16-km road segments

throughout the entire basin, there were very few segments of continuous presence (Figure 12), and variability ranged from low to high on different roads (Table 5). This is surprising, because spread of the *C. arvensis* is mainly by rhizomes or root segments which spread from a fibrous taproot, sending up aerial shoots at 2 to 6 inch intervals (Holm *et. al.* 1991). Clonal patch extension through underground growth is rapid, as roots can spread up to five meters per year (Holm *et. al.* 1991, Anderson 1999). Given these biological traits, it was expected *C. arvensis* would be present in more continuous stretches and less patchy on the road network. The 0.16-km sampling interval may be at a scale too coarse to detect the clonal patch extension of *C. arvensis* on the roads. The discontinuous distribution of *C. arvensis* on the road network, its range in spatial variability on different roads, its limited occurrence in comparison to the widespread regional distribution, and its small decrease from 1994 to 2005 indicates that physical and environmental barriers may be limiting the distribution of *C. arvensis* in the H.J. Andrews Forest. This species is most often cited as an agricultural weed, and is best known as an invader of non-forested plant communities such as prairies, savannas, sand dunes, and meadows, which may account for its limited occurrence in the steep, wet, forested landscape of the H.J. Andrews.

D. purpurea is limited in its regional distribution to the coasts of Washington and Oregon, as well as some counties in northern and central Idaho (Rice 2006), but it is abundant in a few specific areas of the road network, suggesting the occurrence of *D. purpurea* at the H.J. Andrews Forest stems from a local introduction. In the northwest by 2005, 18% of counties had reported presence of *D. purpurea* (Rice 2006). *D. purpurea* occurred along 8.2% of the road network in and around the H.J.

Andrews in 2005, and ranked 9th in frequency of the species sampled, which compares well with the regional distribution (Table 3). However, documentation of *D. purpurea* in the northwest has not changed since 1986, yet *D. purpurea* increased 7.6% on the road network from 1994 to 2005 and ranked 2nd in percent of increase of the species sampled.

In 2005, *D. purpurea* was heavily concentrated within the H. J. Andrews boundary as common or abundant patches on road 360 and the first few kilometers of road 1506, but was discontinually distributed and rare in abundance on the major roads of 15 and Hwy 126 (Figure 18). Although it has been present for at least 70 years in the northwest (Table 14), *D. purpurea* is not a widespread exotic species in the Oregon Cascades, and both Lane and Linn Counties serve as the eastern extent of its range in central Oregon. Contrary to many other target species surveyed in 2005, *D. purpurea* was less common on the major roads of 15 and Hwy 126, perhaps reflecting the fact that this area serves as the eastern edge of *D. purpurea*'s distribution in Oregon. *D. purpurea* was heavily concentrated within the H.J. Andrews Forest, particularly in one specific area (road 360 near Mack Creek). Relative to the region, *D. purpurea* can be regarded as a local source population, and its current distribution is likely more of a function of local introduction, perhaps as propagules attached to car tires and hiking boots of researchers working in Mack Creek, as opposed to a sink population from regionally located sources, which would be evident in higher abundances on the major roads of Hwy 126 and road 15. This pattern is also manifest in the relative abundance distribution of *D. purpurea* at the H.J. Andrews forest, as

37.6% of all present segments had greater than 10 individual plants per 0.16-km segment (Table 4), again highlighting the locally high relative abundance.

C. vulgare has been documented in the northwest since 1883, and although widely distributed at the H.J. Andrews forest, this species significantly decreased from 1994 to 2005 and was highly variable on the road network, indicating that it may be in a dynamic state of change at the H.J. Andrews Forest. In the northwest by 2005, 72% of counties had reported presence of *C. vulgare* (Rice 2006). *C. vulgare* occurred along 42.1% of the road network in and around the H.J. Andrews Forest in 2005, and ranked 4th in frequency of the species sampled, which compares well with the regional distribution (Table 3). Documentation of *C. vulgare* in the northwest has risen 23% since 1990 (Table 14), but *C. vulgare* decreased 20% on the H.J. Andrews road network from 1994 to 2005, in sharp contrast to the regional expansion.

C. vulgare has been present in Lane and Linn counties for at least 65 years (Table 14), and is widely distributed on the road network, which indicates that this species has been present in the vicinity of the H.J. Andrews for decades. *C. vulgare* is discontinuously distributed on Hwy 126 and road 15, and more continuous on lower elevation roads at the H.J. Andrews (Figure 9). It is interesting to note the lack of *C. vulgare* on the eastern portion of Hwy 126, contrasted against the continuous distribution at the beginning of road 2654 (Deer Creek Road), and the continued but sporadic presence along road 2654 and on portions of the connecting road 700 (Figure 9). The beginning of road 2654 contains a small parking area, some camp sites, and local access to Deer Creek, and this spot may serve as a local source for propagules moving up the road network into areas over the eastern ridge of the H.J. Andrews

Forest. The H.J. Andrews populations of *C. vulgare* are separated from the Deer Creek Road populations by the high-elevation extent of road 1506, where *C. vulgare* was absent from south to north running along the eastern boundary of the experimental forest. The difference in presence/absence on southern and eastern portions of Hwy 126 may reflect different seed source-sink dynamics on the landscape in and around the H.J. Andrews Forest. The H.J. Andrews populations, which are widely distributed and concentrated on the lower elevation roads, could have been introduced during logging activity during the 1950s and 1960s, while the populations in the Deer Creek Basin may be a function of spread from the recreational sites on road 2654.

B. sylvaticum was first reported in the northwest in Eugene, Oregon in 1939 (Rice 2006), and while never documented in Linn County, this species demonstrated considerable, concentrated presence on the road network at the H.J. Andrews in 2005, indicating that it could be in the dynamic expansion phase of its spread (Figure 119). *B. sylvaticum* is unique to Oregon, and had been documented in only 4 counties by 2005. *B. sylvaticum* occurred along 8.3% of the road network in and around the H.J. Andrews Forest in 2005, and ranked 8th in frequency of the species sampled (Table 3), which is high compared to the limited regional distribution of *B. sylvaticum* in the northwest.

In and around the H.J. Andrews in 2005, *B. sylvaticum* was concentrated in continuous segments on road 15 near the junction with road 130, on the beginnings of roads 1506 and 2654, as well in discrete patches randomly located throughout the H.J. Andrews Forest (Figure 13). *B. sylvaticum* was very scarce or absent from Hwy 126, the Deer Creek roads over the east ridge, as well roads 1508, 130, and 1507 which

extend upslope into higher elevations. *B. sylvaticum* was found in both Lane and Linn counties, which is significant as presence has not been previously documented in Linn County. The considerable presence of *B. sylvaticum* on the road network is surprising, considering that this species has never been reported in part of the study area (Linn County), was not notable enough to be included in the 1996 road survey (Parendes 1997), and is limited in its regional distribution to only four counties in Oregon (Rice 2006). *B. sylvaticum* was only 3.4% less frequent than *C. arvensis*, which is one of the most widespread exotic plant species in the entire northwest. Additionally, 63.1% of the presence recorded on the road network was at common (11 to 100 plants per 0.16-km segment) or abundant (greater than 101 plants per 0.16-km segment) levels, so the majority of the colonized areas contained more than 11 plants per 0.16-km segment (Table 4). This high relative abundance is most apparent on the paved section of road 1506 near the junction with road 300, and road 15 near the junction with road 130 (Figure 20). The considerable, concentrated presence of *B. sylvaticum* on the H.J. Andrews road network demonstrates the strong invasion capability of this exotic plant, which has not only expanded its distribution in a short period of time, but it is also widespread on the road network, indicating it may have been present in the vicinity of the H.J. Andrews for decades. *B. sylvaticum* has the potential to increase in both frequency and abundance, and could begin to outcompete native plants of the H.J. Andrews Forest in the future.

S. jacobaea has increased rapidly in the northwest since 1990, and although frequent on the network, this species increased only minimally at the H.J. Andrews, perhaps due to a successful biological control program. In the northwest by 2005,

28% of counties had reported presence of *S. jacobaea* (Rice 2006). *S. jacobaea* occurred along 26.1% of the road network in and around the H.J. Andrews in 2005, and ranked 5th in frequency of the species sampled (Table 3), which is high compared to the regional distribution. Documentation of *S. jacobaea* in the northwest has risen 46% since 1990 (Table 14), but *S. jacobaea* only increased 3.4% on the road network from 1994 to 2005, far less in comparison to the regional trend. The small increase on the road network may be a function of biological control of *S. jacobaea* due to defoliation from the cinnabar moth, which was released to control this species in 1960 in western Oregon (McEvoy *et. al.* 1991). The cinnabar moth may be a control on the increase of *S. jacobaea* at the H.J. Andrews, but may not be affecting plants in the greater northwest, perhaps explaining the difference between the regional expansion of *S. jacobaea* and the small increase in frequency at the H.J. Andrews.

Although being regionally present since 1910, *S. jacobaea* was not reported in either Linn or Lane County until 1954 (Table 14). *S. jacobaea* was widely distributed on the road network in 2005, indicating this species has been in the vicinity of the H.J. Andrews Forest for decades. Unlike other target species sampled, *S. jacobaea* was scarce to absent on Hwy 126, road 15, and the first few kilometers of roads 1506 and 2654 (Figure 11). Absence of *S. jacobaea* in high-traffic areas is surprising given that this species was the fifth most frequent sampled. This perhaps indicates that patches within the H.J. Andrews Forest are a local population and not the result of propagules dispersed from a regional population, which would be expected on Hwy 126.

L. muralis was not documented in the northwest until 1934, and is currently limited to a few select counties in its regional distribution, but was very frequent on

the road network at the H.J. Andrews Forest, perhaps as a function of its shade-tolerance and possible multiple introductions through logging activity. In the northwest by 2005, only 7% of counties had reported presence of *L. muralis* (Rice 2006). *L. muralis* occurred along 77.9% of the road network in and around the H.J. Andrews in 2005, and ranked 3rd in frequency of the species sampled, which far exceeds the regional distribution pattern (Table 3). Documentation of *L. muralis* in the northwest has risen 46% since 1990 (Table 14).

This extensive representation is very surprising, considering the rarity of *L. muralis* both in the entire northwest and in the western Oregon region. *L. muralis* had never before been documented in Linn County, but is widely distributed at the H.J. Andrews and is present on many roads over the Linn County border. *L. muralis* has been present at the H.J. Andrews at least since 1971, where it was found in disturbed areas and included in a vascular checklist of plants compiled at the H.J. Andrews Forest (Franklin and Dryness 1971). However, it was not sampled on the network by Parendes in 1996 (Parendes 1997). Perhaps *L. muralis* was introduced during extensive road building and timber harvest activity in the 1950s and 1960s. While other species originally established in clearcut areas may have decreased in frequency related to a decrease in light availability associated with canopy closure, *L. muralis* is shade-tolerant (Parendes 1997), and thus could have rapidly expanded post-establishment on the road network independent of changes in light levels. This is supported by the CART analysis, which revealed presence of *L. muralis* to be best predicted by roads constructed before 1960, which are located toward the shaded valley floors at the center of the road network (Figure 91). The potential multiple

introductions of *L. muralis* on the landscape through logging activity and road construction and its independent relationship with light may explain why this species is rare in the northwest but locally very dominant at the H.J. Andrews Forest.

R. discolor was one of the latest of the 11 target species to be documented in the northwest (1922), and although widely distributed at the H.J. Andrews, it is far less frequent in the experimental forest than on the major roads of Hwy 126 and 15, suggesting that heavy traffic may be responsible for its spread. In the northwest by 2005, only 8% of counties had reported presence of *R. discolor* (Rice 2006). *R. discolor* occurred along 7.8% of the road network in and around the H.J. Andrews in 2005, and ranked 10th in frequency of the species sampled, which compares well with the regional distribution (Table 3). Documentation of *R. discolor* in the northwest has risen 19% since 1990 (Table 14), but *R. discolor* increased only 1.0% on the road network from 1994 to 2005, less than the regional pattern of increase.

R. discolor was not recorded in Lane County until 1934, and not in Linn County until 1979 (Table 14), but it was widespread in and around the H.J. Andrews Forest, suggesting it has been present in the vicinity for decades. It is interesting to note that *R. discolor* has been recorded in Lane County for the last 72 years, but in Linn County for only 26 years, and the Lane County area includes the continuous segments of presence on the roads 126 and 15, while *R. discolor* was absent on almost all Linn County roads in the study area, including the end portions of roads 1506, 2654, 350, 359 and road 700 (Figure 16).

In 2005, *R. discolor* was found on only 1.5% of the road network in the H.J. Andrews Forest, but was continuously distributed on roads 15 and Hwy 126 south of

the H.J. Andrews (Figure 16). On Hwy 126, *R. discolor* was abundant (greater than 100 plants per 0.16-km segment), and on road 15 *R. discolor* was common (11-100 plants per 0.16-km segment) (Figure 19). Interestingly, *R. discolor* was absent or rare on Hwy 126 east of the H.J Andrews Forest, road 2654, and within the H.J. Andrews Forest in general. The striking difference between abundance of *R. discolor* at the south of the basin and within the forest boundary may highlight the role of vehicle traffic in the spread and proliferation of *R. discolor* in this area. Hwy 126 south of the H.J. Andrews Forest contains a boat loading area for access to the McKenzie River, and road 15 is the major access road for the Blue River Reservoir, two popular spots for summer recreation which are subject to much vehicle and foot traffic. These heavily invaded areas could be serving as propagule sources for the randomly distributed *R. discolor* patches on the H. J. Andrews road network. The link between *R. discolor* and traffic is also evident from the CART analysis, which revealed that proximity to rain gauging stations was the second best predictor of the presence of *R. discolor* on the road network at the H.J. Andrews in 2005 (Table 9).

C. maculosa was the latest of the 11 target species to be documented in the northwest (1935), and is widespread across much of the northwest region, but is localized in one small area of the road network at the H.J. Andrews, suggesting a more recent and specific introduction into the area. In the northwest by 2005, 91% of counties had reported presence of *C. maculosa* (Rice 2006). *C. maculosa* occurred along only 3.7% of the road network in and around the H.J. Andrews in 2005, and was the least frequent of the species sampled, which falls far below the frequency of the regional distribution (Table 3). Documentation of *C. maculosa* in the northwest has

risen 46% since 1990 (Table 14). The current widespread, regional distribution of *C. maculosa* is as extensive as that of *C. arvensis*, which was introduced in the northwest 40 years earlier, and in Lane and Linn counties at least 50 years earlier, highlighting the rapid rate of increase of this species.

C. maculosa was not recorded in either Lane or Linn Counties until 1992 (Table 14), and it is not widespread on the road network at the H.J. Andrews. In and around the H.J. Andrews in 2005, *C. maculosa* was nearly absent except for one continuous stretch of presence on road 410, with some additional continuous segments on both south and east portions of Hwy 126 (Figure 17). The highly localized occurrence of *C. maculosa* on road 410 may be a function of recent introduction by researcher activity. Road 410 is often visited during field trip tours of the H.J. Andrews, in which vans full of people stop and walk around the location, thus increasing the potential for seed dispersal and spread (Fred Swanson, personal communication). Additionally, CART analysis revealed that presence of *C. maculosa* was more likely to be found in areas clearcut after 1980 (Figure 99), so more recent timber harvest activity could also be a source of recent introduction at the H.J. Andrews.

Therefore, time since introduction could be a factor limiting the current distribution of *C. maculosa* on the road network. Similar to *B. sylvaticum*, *C. maculosa* has the potential to become a serious invader of the H.J. Andrews Forest in the future, because it has expanded its distribution throughout the northwest at a rapid rate.

Spatial Pattern of Distributions in 2005

The lack of a consistent patch size for almost all exotic plant species on the road network supports the notion that each species has a particular interaction with environmental and landscape factors, which are heterogeneously distributed in the landscape. *C. scoparius* was the only species with discernable patches of consistent size (Figure 25), and in many cases the patch size roughly correlated to the average size of clearcut patches on the road, supporting the link between presence of *C. scoparius* and location of clearcut units. If exotic plants had a direct relationship with any landscape factor, such as canopy cover, patch size would reflect this pattern and the nature of the discontinuous distributions would be more regular on the network. However, the spatial structure of almost all exotic plant distribution is random, indicating that the landscape factors have variable effects on the presence/absence of exotic plants.

In general, the most frequently occurring species at the H.J. Andrews had low spatial variability measured by semivariance, because they were distributed continually on the network. In contrast, *B. sylvaticum*, one of the rarer species sampled, demonstrated very low spatial variability on individual roads (flat semivariograms), and on the network as a whole (each road had very similar semivariance values) (Table 5). This may indicate that *B. sylvaticum* has been present in the landscape for a long time but at very low frequencies, consistent with the notion of a slow expansion lag phase, often described as part of the logistic growth curve in a conceptual model of invasion over space (Figure 119).

Shade-tolerant, *B. sylvaticum* is abundant both on the road and trail network and in the understory canopy of the McDonald-Dunn Forest in Corvallis, Oregon, which is managed by the Oregon State University College of Forestry. If *B. sylvaticum* had been introduced more recently, perhaps as a function of forest researchers from Oregon State working in both the McDonald-Dunn Forest as well as at the H.J. Andrews, it would be expected that *B. sylvaticum* would be randomly distributed throughout the road network, and that variability in presence both on individual roads and on the network as a whole would be high. While small patches of rare and common relative abundance exist in remote areas of the network, the majority of *B. sylvaticum* is concentrated in abundant levels on road 15 near the junction of road 130, and along several kilometers of road 1506 near the mouth of the watershed and the entrance to the experimental forest (Figure 20). These locations could be sites of an earlier introduction of *B. sylvaticum*, perhaps as part of seeding mixes to prevent cut slope erosion during road construction (Dyrness 1967, 1970, 1975).

If *B. sylvaticum* was introduced to both landscapes many decades ago but failed to spread at the H.J. Andrews, one possible reason for the temporal difference in the expansion of *B. sylvaticum* at the H.J. Andrews and the MacDonald-Dunn Forest could be that climatic and environmental conditions in these two locations are quite different. The H.J. Andrews area represents the high-elevation, moist, remote habitat typical of the Cascade Mountains, while the McDonald-Dunn Forest typifies a drier, low-elevation, highly fragmented habitat typical of the Coast Range. A 1992 study at the McDonald-Dunn Forest found that *B. sylvaticum* occurred on low slope gradients, drier soils, and high levels of solar radiation (Leavell 1992). However, at the H.J.

Andrews Forest in 2005, CART analysis revealed *B. sylvaticum* to be associated with roads constructed in the 1940's, which are located on the shaded valley floor, and on north-facing slopes, which are typically cooler and wetter than their south-facing counterparts (Table 9). This difference in habitat preference indicates that *B. sylvaticum* may behave differently at the McDonald-Dunn Forest than at the H.J. Andrews Forest. *B. sylvaticum* could have been introduced at similar times in both areas, but could have reached the expansion phase years earlier at the McDonald-Dunn Forest, while just now reaching the expansion phase at the H.J. Andrews (Figure 119).

With the exception of *B. sylvaticum*, less frequent species on the road network had no consistent trend of spatial variability. The lack of consistent spatial autocorrelation supports the notion that these species may be at an earlier phase in their invasion, and are responding in different ways to the heterogeneous distribution of landscape factors such as elevation, temperature, and precipitation on the road network.

Change in Species Distributions and Spatial Pattern from 1994 to 2005

Six species, *H. perforatum*, *C. leucanthemum*, *S. jacobaea*, *C. scoparius*, *D. purpurea*, and *R. discolor*, increased in frequency on the road network from 1994 to 2005 (Table 6). *C. leucanthemum* demonstrated the largest net increase (14.7%) over the 11-year period, especially on road 130, which runs along a south-facing slope at low to medium elevation, where long, continuous segments of presence in 2005 have replaced the few, randomly distributed patches at higher elevations from 1994 (Figure 29). *C. leucanthemum* is a prolific producer of small, light, wind-dispersed seeds, and

could have increased in frequency as a function of researcher traffic dispersing seeds embedded in the mud and dirt on vehicle tires. Road 130 is a medium-use road, and has both a rain gauge station located past the junction with road 134, as well as a recent timber sale unit located on the last mile, and both areas are often visited by researchers and/or loggers.

D. purpurea increased 7.6% on the road network, but in contrast to *C. leucanthemum*, its expansion was localized on the first few kilometers of road 1506 and on the second half of road 360 (Figure 30). *D. purpurea* is also a prolific producer of small, wind-dispersed seeds, which are lighter than those of *C. leucanthemum* (0.09 mg as opposed to 0.22 mg), and on average passively dispersed farther (4 meters as opposed to 2) than the seeds of *C. leucanthemum*. Both species were recorded around the same time (1920s) in Linn and Lane counties, and both were included in the 1971 checklist of vascular plant species at the H.J. Andrews, but *C. leucanthemum* is much more frequent and demonstrated a larger and more spatially distributed increase on the road network. This could indicate that *C. leucanthemum* has been introduced at multiple times and in multiple places on the road network, but that *D. purpurea* was introduced to the H.J. Andrews Forest specifically in one location, on roads 1506 and 360. This introduction could have taken place in the 1970's during experiments in which researchers were traveling back and forth from the Coast Range, where *D. purpurea* is more common than in the Cascades. *D. purpurea* is rare to common along road 1506 and abundant on sections of road 360 (Figure 18), again supporting the hypothesis that seeds of *D. purpurea* could have been moderately dispersed by vehicles driving to the experimental sites on road 1506, and then more intensely

dispersed at the sites themselves on road 360, where vehicles were parked and researchers got out and walked on the road.

Two species, *C. vulgare* and *C. arvense*, decreased in frequency on the road network from 1994 to 2005 (20.0% and 1.2%, respectively) (Table 6). Spatial analysis revealed fragmentation of large patches of *C. vulgare* from 1994 on many roads in 2005, as well as the loss or decrease in size of patches present in 1994 on roads in 2005 (Table 8). Loss of *C. vulgare* is especially evident on the last few kilometers of road 1507 which extends to high elevations on the south side, and the last few kilometers of roads 350 and 320, which extend to high elevations on the north side (Figure 36). The disappearance of *C. vulgare* from large sections of high elevation roads correlates with other research indicating that occurrence of this species can be ephemeral from year to year. In a study of *C. vulgare* populations in coastal sand-dunes of the Netherlands, 51% of *C. vulgare* plants had disappeared from 2-m plots within two years, and seedling survival demonstrated large temporal and spatial variation (Klinkhammer *et. al.* 1988). The lack of a persistent seed bank in the soil (Roberts and Chancellor 1989), intense seed predation by mice and voles (Klinkhammer *et. al.* 1988) and high seedling mortality may be biological factors underlying the large net decrease in the frequency of *C. vulgare* on the road network in 2005.

Spatial analysis using standardized semivariograms revealed that there were few discernable trends by species or by road, although the change in semivariogram structure from 1994 to 2005 did explain patterns of increase and decrease in species frequencies on the road network. The most frequent species, *C. leucanthemum* and *H.*

perforatum had lower gap/patch ratios in 2005 as a result of the filling in of gaps from 1994 to form long, continuous segments which extend throughout the road network in 2005 (Table 8), indicating these species may have reached the equilibrium stage of invasion on the landscape (Figure 119).

On road 350, which extends upslope into high elevations on the north side, every species sampled experienced some form of spatial pattern change. Road 350 extends over three elevation classes, canopy cover varies from medium high to low, aspect is mainly south at the base and west at top, and road use is high (Figures 72, 74, 76, 78). The consistent trend of change in spatial pattern for all species sampled on the 350 road may be a result of the interaction between landscape attributes and human-use patterns. The 350 road has a new climate station that was established in 1996, and also serves as the access road for the lookout station on Carpenter Mountain (Julia Jones, personal communication). High traffic on road 350 increases the potential for seeds to be carried across environmental barriers, depositing them on segments with varying degrees of light availability and temperature associated with different elevations and aspects. Increased seed dispersal due to high levels of traffic may be interacting with the distribution of landscape factors, resulting in the high degree of spatial pattern change on road 350 from 1994 to 2005.

Very few species demonstrated a spatial gradient pattern in either 1994 or 2005 (Table 8). Evidence of a spatial gradient may indicate that species are responding to an environmental factor distributed along a similar gradient, such as elevation or precipitation. Landscape variables such as canopy cover, elevation, precipitation, and age of road construction all change systematically from the center of the basin on the

valley floor upslope to higher elevations at the periphery of the road network at the H.J. Andrews Forest. If one of these attributes were significantly controlling spatial pattern of species occurrence, it would be expected that species distributions would be arranged in a similar gradient pattern from the beginning to the end of roads.

Landscape Variables Associated with Presence in 2005

Distribution of exotic species has been shown to correlate with the degree of human disturbance on the landscape, such that invasion is more prevalent in open, exposed areas with increased light levels (Wolf et. al. 2003; D'Antonio 2004; DeFerrari & Naiman 1994). In this study, coarse-scale patterns of exotic species corresponded to physical/climatic gradients of elevation, temperature, light, and precipitation, as well as exposure to prevailing winds.

CART analysis revealed elevation and canopy cover were the landscape factors which best predicted exotic species presence/absence in 2005. These results suggest that species distribution patterns may be explained by interactions between life history traits and location and date of introduction to the area. *H. perforatum* and *C. leucanthemum* are the two most frequent species at the H.J. Andrews, and both have been present in the region since the 1920's. These two species were also the most frequent in 1994, and their dominance at higher elevations may be a reflection of the fact they have been present on the landscape long enough and at such a level of abundance that they have reached the equilibrium phase of expansion, as their distributions now extend to the extreme periphery of the road network.

The dominance of *C. scoparius*, *R. discolor*, and *D. purpurea* at lower elevations may suggest that these species are approaching the limit of their

elevation/temperature tolerances. These species were found at lower elevations in 1994, and were very rare on the high elevation roads of 1507, 350, and the end of 1506 in both 1994 and 2005. *C. scoparius* has been present in the region since 1917, and *D. purpurea* since 1934 (Table 14), so these species have had time to invade the entire the network (like *C. leucanthemum* and *H. perforatum*), but are much less frequent on the H.J. Andrews road network than *C. leucanthemum* and *H. perforatum*. *C. scoparius* is rarely reported above 1200 m (Hoshovsky 2001), and the growth of *C. scoparius* drops sharply with altitude (Williams 1981).

The limited distributions of these species may also be explained by differences in life history traits, as *C. scoparius* and *R. discolor* are perennial, woody shrubs with heavy seeds (7.6 mg and 5.24 mg, respectively) that may not be as easily dispersed to higher elevations as *C. leucanthemum* and *H. perforatum*, which have smaller, lighter seeds (0.22 mg and 0.13 mg, respectively). However, *D. purpurea* is also restricted to lower elevations, even though it has very light seeds (0.09 mg).

The finding that canopy cover had a slightly positive relationship with the presence in 2005 of some select species was surprising, as other studies have cited a positive relationship between light levels and exotic species presence (Forcella and Harvey 1983, Brothers and Spingarn 1992, Wilson *et. al.* 1992). However, canopy cover is confounded with other landscape factors at the H.J. Andrews Forest. Areas of the network with medium to high degrees of canopy cover also had low mean annual precipitation and were at lower elevations. Thirty-seven percent of all segments classified as medium canopy cover also had the lowest mean annual precipitation (< 2400 mm/yr), and 25% of all segments classified as medium canopy cover also were

at medium elevations between 600 and 900 m (Table 12). Therefore, the relationship between medium to high canopy cover and the presence of *C. leucanthemum* and *S. jacobaea* may really be a function of a relationship between these species and lower levels of precipitation or medium levels of elevation.

C. vulgare was most likely to occur on segments where canopy cover ranged from medium-low to medium-high, perhaps suggesting that high light and high shade conditions limit the distribution of this species. *C. vulgare* is not shade tolerant; is unlikely to be found in areas where light is reduced to less than 40% full sun (Klinkhammer and De Jong 1993). The dominance of *C. scoparius* on medium-low to very-low canopy cover segments is consistent with other research that has linked *C. scoparius* to high light conditions in disturbed areas, as *C. scoparius* does not proliferate in heavily shaded forests (Hoshovsky 1986). Sheppard *et. al.* (2002) found disturbance to significantly increase seedling survival, presumably due to increased light availability with the removal of overstory canopy. Paynter *et. al.* (1998) also found seed germination to be higher in open-canopy disturbed plots, and 40% of seedlings survived to their first summer in disturbed plots while none survived in control plots.

Landscape Variables Associated with Increase from 1994 to 2005

CART analysis revealed elevation, canopy cover, and road traffic were the landscape variables associated with species increase from 1994 to 2005. This suggests that change in exotic species distributions from 1994 to 2005 may reflect a multi-decade spread of species from points of introduction at the center of the basin on

valley floor roads to the far extensions of the road network. *H. perforatum* was the most frequent species on the road network in 1994. Its increase at high elevations from 1994 to 2005 completed its colonization of the road network (now covering 98.7% roads at the H.J. Andrews). *H. perforatum* may be reaching the equilibrium stage on the landscape (Figure 119), although there is some room for additional expansion on the roads over the high east ridge of Lookout Basin.

S. jacobaea may be in an active expansion phase of its spread across the landscape. *S. jacobaea* was introduced late to the area (1954), but is now is the fifth most frequent exotic species out of the target 11 sampled on the road network at the H.J. Andrews Forest. Although it expanded on 16.0% of roads over the 11-year period, *S. jacobaea* simultaneously disappeared from 12.6% of roads. *S. jacobaea* disappeared from roads on the valley floor which tend to be shaded, but increased on roads at higher elevations (Figure 33). *S. jacobaea* appears to be advancing as a wavefront from a few single points of introduction at the lower valley roads up to the peripheries of the network, despite the introduction of a biological control agent. The cinnabar moth was released near the H.J. Andrews area in 1960, and a 12-year survey of its effect on forty-two *S. jacobaea* populations in western Oregon showed strong and persistent depression of *S. jacobaea* spread (McEvoy *et. al.* 1991). The closing canopies along lower elevation roads as plantations have regenerated in clearcuts established in the 1950s and 1960s may account for decrease at lower elevations, because *S. jacobaea* requires seedling disturbance in areas with increased light availability to become established (van der Meijden and van der Waals-kooi 1979).

The relationship between increase in species distributions and elevation may also indicate that the landscape contains some environmental barriers to species expansion. These environmental barriers may be acting differently for different species based on their tolerances for temperature, precipitation, and light availability. *C. scoparius*, *D. purpurea*, and *R. discolor* may have a restricted ability to increase due to limitation by environmental barriers such as precipitation and temperature, which are arrayed on a coarse scale along with elevation. However, species such as *C. leucanthemum* and *L. muralis* may have a wider range of tolerance for colder temperatures and more precipitation, and are thus not limited by these environmental barriers, as demonstrated by their increase at the higher elevations.

Canopy cover and road traffic were the second most often selected predictors of increase in species distributions from 1994 to 2005. *C. leucanthemum*, *C. arvense*, and *C. scoparius* all increased along roads with very low to medium canopy cover. Forcella and Harvey (1983), Brothers and Spingarn (1992), and Wilson *et. al.* (1992) also noted that exotic species were more frequent in areas with high light levels.

Relatively high levels of traffic also were associated with locations where *C. vulgare* and *R. discolor* increased from 1994 to 2005. *C. vulgare* is a prolific producer of small, light seeds (3.0 mg) (Bennet 2001, Klinkhammer *et. al.* 1988) which can be dispersed by wind or on the tires of research vehicles. *R. discolor* berries are heavy and dispersed by animals and birds. However, *R. discolor* will not produce seed in heavy shade, and so could be expected to increase in areas with less canopy cover and more light availability, typically the high-use roads.

Landscape Variables Associated with Decrease from 1994 to 2005

The decade of creation of the adjacent clearcut, elevation, canopy cover, and mean annual precipitation were associated with exotics species decrease from 1994 to 2005. These results indicate that light availability is an important factor in species presence, as canopy closure along roads adjacent to early clearcuts shades out light demanding exotic species. *R. discolor* and *C. vulgare* decreased on portions of the road network which had not been cut, or which had been cut after 1960. *H. perforatum* decreased on portions of the road network with clearcuts from the 1960s, and *C. leucanthemum* decreased on portions of the road network with clearcuts from the 1970s. On the other hand, *C. leucanthemum* and *C. scoparius* decreased on roads with very low to medium canopy cover. Again, this may be a function of correlation of variables on the landscape as opposed to a direct effect of high light availability on decrease in exotic species presence. The majority of low canopy cover segments are located at the highest elevations on the road network (above 1200 m) (Table 12). The decrease of these species may be a function of changing temperature, precipitation, or wind variations at high elevations, which also happen to be more exposed to sunlight.

Correlations Between Landscape Variables

Presence of exotic species in 2005 and the change in exotic species distributions from 1994 to 2005 were associated with many landscape factors in this study. Many of the explanatory variables are correlated in the landscape (Figure 120). These correlations make it impossible to attribute exotic species dynamics to any single factor.

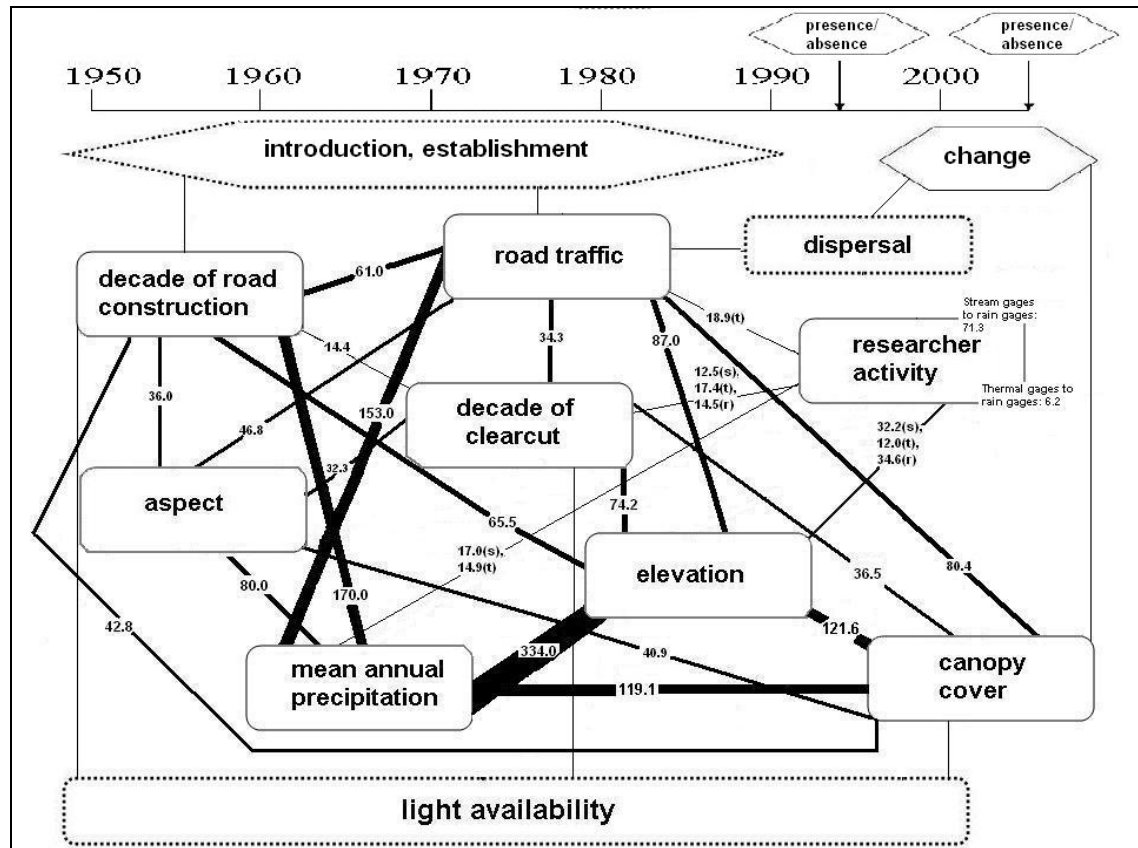

Figure 120. Conceptual diagram of exotic plant invasion over time, demonstrating correlations between explanatory landscape factors. Thickness of the connector lines represent the degree of correlation between explanatory variables in the CART analysis, based on results of chi-square tests of independence.

The decade of road construction, decade of the adjacent clearcut, canopy cover, and road traffic are distributed similarly to elevation and precipitation on the H.J. Andrews Forest landscape (Figure 120). Correlations are especially strong between elevation, mean annual precipitation, canopy cover, decade of road construction, and road traffic. The lower elevation roads were built earlier, experience more traffic, receive less precipitation, and have higher degrees of canopy cover. These relationships explain some of the mixed results in the CART analysis, as any of these five variables could have appeared as the most significant explanatory landscape

factor for the presence, increase or decrease of particular species. Moreover, aspect and proximity to gauging stations explained very few of the relationships between exotic species and landscape variables, nor did they show strong correlations to any others in the study. Correlations between landscape attributes make direct causal relationships between individual factors and species distributions difficult to ascertain, and further study of individual target species is needed to determine the individual effects of physical/climatic processes or human-use patterns.

Support of Hypotheses

Hypothesis 1

The results of this research support, to some extent, the hypothesis that exotic species distributions are correlated with the location of clearcuts, where they could have been introduced by logging traffic, and where they would have been maintained over time by high light availability from open canopy conditions. Distribution of *C. scoparius*, *C. arvense*, *S. jacobaea*, and *C. maculosa* are visually associated with clearcuts. Location of clearcuts from the 1970s and 1980s were the best explanatory variable for the distribution of *C. maculosa*, which may indicate this species was introduced more recently to the H.J. Andrews as a function of logging activity during this time. However, hunters and field trip visitors use this location (road 410) as well (Craig Creel, personal information), so logging may not be the sole reason for the recent appearance of this species. The late introduction may explain why *C. maculosa* is not more widespread at the H.J. Andrews, as it is in other places throughout the Pacific Northwest.

Elevation and canopy cover were most often selected as the best explanatory variables for species distributions in 2005, but because of their strong correlation with age of the clearcuts (chi-square values of 74.2 and 36.5, respectively) the locations of clearcuts cannot be disregarded as a possible explanatory variable for exotic species presence. In fact, *C. scoparius*, *D. purpurea* and *R. discolor* were most closely associated with low to medium elevations (below 900 m), and 19.7% of segments on the road network in these elevation categories also had adjacent clearcuts harvested in the 1950's, while 12.4% of segments at low to medium elevations had adjacent clearcuts harvested in the 1960's, indicating that presence of these species could be partially explained by patterns of timber activity on the network.

Hypothesis 2

The hypothesis that changes in exotic species distributions over time are a function of dispersal processes along road corridors, driven by logging and researcher traffic and changes in light availability with closing canopy cover along less traveled roads was supported, in part, by this study.

Road traffic was a factor in the increase of some species, as high and medium traffic on roads best explained the increase in *C. vulgare* and *R. discolor*.

Additionally, high use roads are located on the main arteries of the road network, at lower elevations, and thus the significant association between increase of *C. scoparius* and *D. purpurea* and low elevations could really be a function of increase due to higher traffic on these roads.

Researcher traffic, which was represented by proximity to rain, thermal, and stream gages on the network, explained little of change in species distributions over time. The representation of researcher traffic patterns using a 250-m buffer around gauging stations was a limitation of this study. The location of gauging stations on the road network is an important consideration because frequent visitation by researchers increases the potential for exotic seed dispersal. Many of the exotic species in this study (*C. leucanthemum*, *D. purpurea*, *B. sylvaticum*, *S. jacobaea*, *C. maculosa*, *L. muralis*, *H. perforatum* and *C. vulgare*) have small, light seeds which are dispersed passively by wind or animals in undisturbed settings. The vast majority of the road network at the H.J Andrews is unpaved, and roads become muddy after rain events. The combination of repeated visits to gauging stations on various portions of the road network and the increased potential of seed dispersal on muddy road tires and boots make gauging stations “hotspots” for potential increase in exotic species. However, once picked up by a muddy tire, seeds can be dispersed at *any location* along the road while traveling to or from a gauging station, and not just within a 250-m buffer, which captures only three 0.16-km road segments, at best. Researcher traffic would have been better represented by categorizing roads based on the number of gauging stations per road, or using other previous knowledge of traffic patterns on the road network (see Figure 121).

For some species, changes in exotic plant species were correlated with changes in canopy cover on the road network, supporting the hypothesis that light availability is a factor governing species changes over time. Lower canopy cover (and thus high light availability) was associated with increases in *C. leucanthemum*, *C. arvensis*, and

C. scoparius. Decreases in *C. leucanthemum* and *H. perforatum* were associated with areas on the network which had been clearcut decades ago; these older clearcuts are reaching canopy closure, shading the roads and perhaps causing a decline in exotic plant species. The decrease in *C. vulgare* was most significantly associated with road segments with medium-high canopy cover, further demonstrating the connection between light availability and change in spatial distribution.

Total Exotic Occurrence and Diversity

Results from the evaluation of exotic plant diversity in 2005 support the hypothesis that exotic species were introduced on low elevation roads constructed during logging activities of the 1950s and 1960s, and became established due to increased light availability adjacent to open canopied clearcuts. CART analysis revealed that exotic plant diversity is greatest at elevations below 900 m, on road segments classified as low or high use (Figure 117). The regression tree also predicted higher numbers of exotics on roads built in the 1940s and 1950s, as opposed to roads built in the 1960s and 1970s (Figure 117). Higher numbers of exotics persist at the older, center of the road network, on the beginning portions of roads 1506, 320, 1507 and 130, while lower numbers of exotics are present at the higher elevation peripheries of the network on the end portions of these roads. The coarse-scale gradient of high to low diversity supports a wave-like model of invasion on the road network, as species introduced at low elevations during road building and timber harvesting activities in the 1950's are expanding upslope over time.

This is further supported by the increase in diversity from 1994 to 2005 at upper elevations on roads 1508, 1506, and 130 (Figures 115 and 116). The coarse-scale gradient of high to low diversity is overlaid by a fine-scale pattern of randomly distributed, discrete patches of individual exotic species, which may have particular interactions with individual environmental factors on the landscape.

The results of this study also support the hypothesis that researcher, logging, and public traffic patterns in the H.J. Andrews Forest are linked to the increase in exotic species diversity over time. CART analysis revealed the highest positive change in exotic species diversity from 1994 to 2005 to occur on high or medium-use roads and on road segments adjacent to a unit clearcut in the 1970s (Figure 118). The regression tree also predicted higher positive change in exotic species diversity on high-use roads as opposed to medium-use roads, and on road segments within 250-m of a thermal gauging station (Figure 118). Exotic species are increasing the most on roads subjected to heavy traffic and on road segments near gauging stations, where vehicle tires and work boots are frequently traveling, increasing the potential for exotic plant seed dispersal.

Additionally, the locations of significant increase in exotic species diversity, the first few kilometers of road 1506, road 360, and end portions of roads 410, 1508, and 130, are all subject to high levels of vehicle and foot traffic by researchers, loggers, and the public (Figure 121).

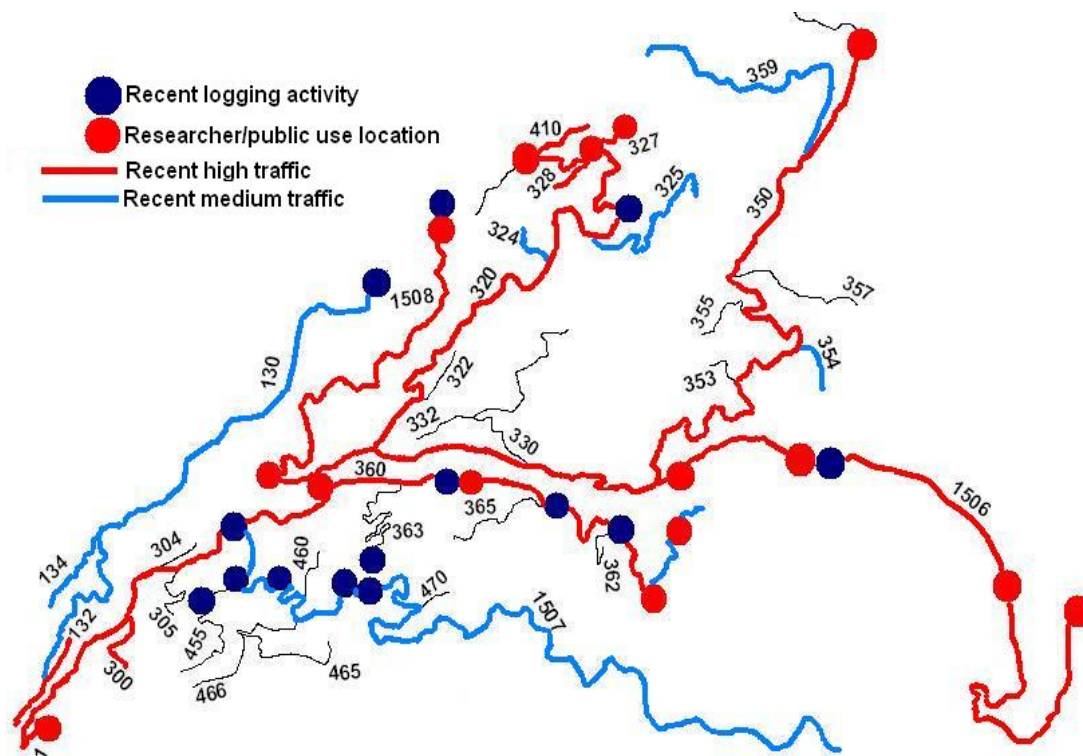

Figure 121. Locations of logging activity, field trip sites, public use locations, and researcher and public traffic patterns in the past decade on the H.J. Andrews Forest road network (Fred Swanson, Julia Jones, and Craig Creel, personal communication).

The first few kilometers of road 1506 is the main entrance to the experimental forest, and is traveled daily throughout the field season. Road 410 is a major attraction for field tours of the H.J. Andrews Forest. Field tours could especially be enhancing exotic plant spread, as field trip locations are frequently visited by large groups of people which drive to these sites in vans and get out and walk around, increasing the number of potential vectors of exotic plant spread.

The end of road 1508 extends out of the H.J Andrews boundary and into upper Blue River, and was recently logged as part of the Blue River Face timber sale unit. The end portion of this road is also visited by touring vans of people, and has been

subjected to high levels of disturbance, including prescribed fire, site management, and monitoring activities (Figure 121). The end of road 130 also runs adjacent to units of the Blue River Face timber sale, so recent activities in this area include road maintenance, logging, hauling, and slash burning over the last 1.5 kilometers. Road 360 has been subjected to recent timber thinning, forestry experiments, and is another major field trip stopping point. High levels of vehicle traffic, as well as the foot traffic of people working and visiting these areas could be facilitating exotic plant spread at the H.J Andrews Forest, thus explaining the high positive change in diversity in these particular locations from 1994 to 2005.

CONCLUSION

This research provides insight into the roles of road traffic and timber harvesting activity on the distribution and 11-year change in exotic plant species on road networks in forested landscapes in the western Cascades. The results of this study suggest that, for some species, exotic plant species are closely related to areas of the network that had been clearcut, and that change in exotic species distributions over time is a function of dispersal processes along road corridors subjected to high vehicle traffic, as well as changes in light availability due to closing canopy cover. Hotspots of exotic plant diversity and abundance also occurred at sites that receive traffic from researchers and public tours, in conjunction with recent logging treatments. However, the high degree of correlation between landscape factors on the road network makes direct causal relationships between exotic species distributions and single landscape attributes difficult to isolate. Individual exotic species have particular interactions with landscape factors which are heterogeneously distributed on the road network. More long-term research is needed to fully address the role of specific types of human activity and change in exotic species distributions over time.

LITERATURE CITED

- Anderson, W.P. 1999. *Perennial Weeds*. Iowa State University Press. Ames, IA.
- Bennet, J.P. 2001. Type characters of non-native plant species in Great Lakes National Parks (USA). In *Plant invasions: species ecology and ecosystem management* Brundu, G., J. Brock, I. Camarda, L. Child and M. Wade, eds. pp 199-206. Backhuys Publishers. Leiden.
- Braithwaite, R.W., W.M. Lonsdale, and J.A. Estbergs. 1989. Alien vegetation and native biota in tropical Australia: the impact of *Mimosa pigra*. *Biological Conservation* **48**: 189–210.
- Breiman, L., J.H. Friedman, R.A. Olshen, and C.J. Stone. 1984. *Classification and Regression Trees*. Chapman and Hall/CRC. Boca Raton, FL.
- Brossard, C. 1991. The role of habitat disturbance, seed predation, and ant dispersal on establishment of the exotic shrub *Cytisus scoparius* in California. *American Midland Naturalist* **126**: 1-13.
- Brossard, C. 1993. Seed germination in the exotic shrub *Cytisus scoparius* (scotch broom) in California. *Madrono* **40**: 47-61.
- Brothers, T. S. and A. Spingarn. Forest fragmentation and alien plant invasion of central Indiana old-growth forests. *Conservation Biology* **6**: 91-100.
- Busch, D.E. and S.D. Smith. 1995. Mechanisms associated with declines of woody species in riparian ecosystems of the Southwestern USA. *Ecological Monographs* **65**: 347-370.
- Cousens, R. and M. Mortimer. 1995. *Dynamics of Weed Populations*. Cambridge University Press. London.
- D'Antonio C.M. 2000. Fire, plant invasions and global changes. In *Invasive species in a changing world*, H. Mooney and R. Hobbs, eds., pp. 65-94. Island Press. Covela, CA.
- D' Antonio, C., N.E. Jackson, C. Horvitz, and R. Hedberg. 2004. Invasive plants in wildland ecosystems: merging the study of invasion processes with management needs. *Frontiers in Ecology and the Environment* **2**:513-521.
- D'Antonio, C.M. and P.M. Vitousek. 1992. Biological invasions by exotic grasses, the grass/fire cycle and global change. *Annual Review of Ecology and Systematics* **23**: 63-87.

- D'Antonio, C.M. and B.E. Mahall. 1991. Root profiles and competition between the invasive, exotic perennial, *Carpobrotus edulis*, and two native shrub species in California coastal scrub. *American Journal of Botany* **78**: 885–894.
- DeFerrari, C.M. and R.J. Naiman. 1994. A multi-scale assessment of the occurrence of exotic plants on the Olympic Peninsula, Washington. *Journal of Vegetation Science* **5**: 247-258.
- Dukes, J.S. and H.A. Mooney. 1999. Does global change increase the success of biological invaders? *Trends in Ecology and Evolution* **14**: 135-139.
- Dunbar, K.R. and K.J. Facelli. 1999. The impact of a novel invasive species, *Orbea variegata* (African carrion flower), on the chenopod shrublands of South Australia. *Journal of Arid Environments* **41**: 37–48.
- Dyer, A.R. and K.J. Rice. 1999. Effects of competition on resource availability and growth of a California bunchgrass. *Ecology* **80**: 2697–2710.
- Dryness, C.T. 1967. Grass-legume mixtures for roadside soil stabilization. USDA Forest Service Research Note PNW-71. Pacific Northwest Forest and Range Experiment Station, Portland, OR.
- Dryness, C.T. 1970. Stabilization of newly constructed road backslopes by mulch and grass-legume treatments. USDA Forest Service Research Note PNW-123. Pacific Northwest Forest and Range Experiment Station, Portland, OR.
- Dryness, C.T. 1975. Grass-legume mixtures for erosion control along forest roads in western Oregon. *Journal of Soil and Water Conservation* **30**: 169-173.
- Errington, J.C. 1973. The effect of regular and random distributions in the analysis of pattern. *Journal of Ecology* **61**: 99-105.
- Evans, R.D., R. Rimer, L. Sperry, and J. Belnap. 2001. Exotic plant invasion alters nitrogen dynamics in an arid grassland. *Ecological Applications* **11**: 1301-1310.
- Forcella, F. 1985. Final distribution is related to rate of spread in alien weeds. *Weed Research* **25**: 181-191.
- Forcella, F. and S.J. Harvey. 1983. Relative abundance in an alien weed flora. *Oecologia* **59**: 292-295.
- Fortin, M.J., P. Drapeau, and P. Legendre. 1989. Spatial autocorrelation and sampling design in plant ecology. *Vegetatio* **83**: 209-222.

- Franklin, J.F. and C.T. Dyrness. 1971. A checklist of vascular plants on the H.J. Andrews Experimental Forest, Western Oregon. USDA Forest Service Research Note PNW-138. Pacific Northwest Forest and Range Experiment Station, Portland, OR.
- Franklin, J.F. and C.T. Dyrness. 1988. Natural Vegetation of Oregon and Washington. Oregon State University Press. Corvallis, OR.
- Gelbard, J.L. and J. Belnap. 2003. Roads as conduits for exotic plant invasions in a semiarid landscape. *Conservation Biology* **17**: 420-432.
- Gilkey, H.M. 1957. Weeds of the Pacific Northwest. Oregon Press, Inc. Portland, OR.
- Grime, J.P., J.G. Hodgson, and R. Hunt. 1988. Comparative Plant Ecology. Unwin Hyman Ltd. Boston, MA.
- Groves R. H. and J. J. Burdon. 1986. Ecology of Biological Invasions. Cambridge University Press. New York, NY.
- Halpern, C.B. and T.A. Spies. 1995. Plant species diversity in natural and managed forests of the Pacific Northwest. *Ecological Applications* **5**:913-934.
- Harmon, M.E. and B. Marks. 1995. Programs to estimate the solar radiation for ecosystem models. Department of Forest Science, Oregon State University, Corvallis, OR. Unpublished.
- Hitchcock, C. L. and A. Cronquist. 1973. Flora of the Pacific Northwest: an Illustrated Manual. Seattle: U of Washington Press. Seattle, WA.
- H.J. Andrews. 2006. H.J. Andrews Experimental Forest LTER, website. <http://www.fsl.orst.edu/lter/> [9/20/05].
- Holm, L.G., D.L. Plucknett, J.V. Pancho, and J.P. Herberger. 1991. The World's Worst Weeds: Distribution and Biology. U. Press of Hawaii. Honolulu, HI.
- Hoshovsky, M. 2001. Element stewardship abstract for *Cytisus scoparius*. The Nature Conservancy, website. <http://tncweeds.ucdavis.edu/esadocs/documnts/cytisco.html/> [11/15/2005].
- Jones, J.A. and G.E. Grant. 1996. Peak flow responses to clear-cutting and roads in small and large basins, western Cascades, Oregon. *Water Resources Research* **32**: 959-974.
- Klinkhamer, P.G.L., T.J. de Jong, and E. van der Meijden. 1988. Production, dispersal and predation of seeds in the biennial *Cirsium vulgare*. *The Journal of Ecology* **76**: 403-414.

- Klinkhamer, P.G.L. and T.J. de Jong. 1993. *Cirsium vulgare* (Savi) Ten.: (*Carduus lanceolatus* L., *Cirsium lanceolatum* (L.) Scop., non Hill). *Journal of Ecology* **81**: 177-191.
- Leavell, D.M. 1992. Relationships between plant associations and environment within McDonald-Dunn Forest. M.S. Thesis, Oregon State University, Corvallis, OR.
- Legendre, P., and M.J. Fortin. 1989. Spatial pattern and ecological analysis. *Vegetatio* **80**: 107-138.
- Levine, J.M., M. Vilà, C.M. D'Antonio, J.S. Dukes, K. Grigulis, and S. Lavorel. 2003. Mechanisms underlying the impacts of exotic plant invasions. *Proceedings of the Royal Society of London, Series B* **270**: 775–781.
- Luken, J.O. and J.W. Thieret. 1996. *Amur honeysuckle*, its fall from grace. *BioScience* **46**: 18-24.
- Mack, R.N., D. Simberloff, W.M. Lonsdale, H. Evans, M. Clout, and F.A. Bazzaz. 2000. Biotic invasions: causes, epidemiology, global consequences, and control. *Ecological Applications* **10**: 689-710.
- Mack, M.C., and C.M. D'Antonio. 2003. Exotic grasses alter controls over soil nitrogen dynamics in a Hawaiian woodland. *Ecological Applications* **13**: 154-166.
- Martin, P.H. 1999. Norway maple (*Acer platanoides*) invasion of a natural forest stand: understory consequences and regeneration pattern. *Biological Invasions* **1**: 215–222.
- McEvoy, P.B., C. Cox, and E. Coombs. 1991. Successful biological control of ragwort, *Senecio jacobaea*, by introduced insects in Oregon. *Ecological Applications* **1**: 430-442.
- Melgoza, G., R.S. Nowak and R.J. Tausch. 1990. Soil water exploitation after fire: competition between *Bromus tectorum* (cheatgrass) and two native species. *Oecologia* **83**: 7–13.
- Milton, S.J. and W.R.J. Dean. 1998. Alien plant assemblages near roads in arid and semi-arid South Africa. *Diversity and Distributions* **4**: 175-187.
- Moody, M.E., and R.N. Mack. 1988. Controlling the spread of plant invasions: the importance of nascent foci. *Journal of Applied Ecology* **25**: 1009-1021.
- Myers, J.H. and D.R. Bazely. 2003. Ecology and Control of Introduced Plants. Cambridge University Press. Cambridge, United Kingdom.

- Parendes, L.A. 1997. Spatial patterns of invasion by exotic plants in a forested landscape. Ph.D. Dissertation, Oregon State University, Corvallis, OR.
- Parendes, L.A. and J.A. Jones. 2000. Role of light availability and dispersal in exotic plant invasion along roads and streams in the H.J. Andrews Experimental Forest, Oregon. *Conservation Biology* **14**: 64-75.
- Parks, C. 2005. Non-native plant invasions of mountainous ecoregions of the Northwest United States. In *Perspectives in Plant Ecology, Evolution and Systematics* (in press).
- Pauchard, A. and P.B. Alaback. 2004. Influence of elevation, land use, and landscape context on patterns of alien plant invasions along roadsides in protected areas of south-central Chile. *Conservation Biology* **18**:238-248.
- Paynter, Q., S. Fowler, J. Memmott, and A. Sheppard. 1998. Factors affecting the establishment of *Cytisus scoparius* in southern France: implications for managing both native and exotic populations. *Journal of Applied Ecology* **35**: 582-595.
- Platt, W.J., and R.M. Gottschalk. 2001. Effects of exotic grasses on potential fine fuel loads in the ground-cover of south Florida slash pine savannas. *International Journal of Wildland Fire* **10**: 155-159.
- Pysek, P. and K. Prach. 1993. Plant invasions and the role of riparian habitats: a comparison of four species alien to central Europe. *Journal of Biogeography* **20**: 413-420.
- Radosevich, S.R., J.S. Holt, and C. Ghersa. Weed Ecology: Implications for Management. John Wiley and Sons. New York, NY.
- Rejmanek, M. 2000. Invasive plants: approaches and predictions. *Austral Ecology* **25**: 497-506.
- Rentch, J. S., R.H. Fortney, S.L. Stephenson, H.S. Adams, W.N. Grafton, and J.T. Anderson. 2005. Vegetation-site relationships of roadside plant communities in West Virginia, USA. *Journal of Applied Ecology* **42**: 129-138.
- Rice, P.M. 2006. INVADERS Database System (<http://invader.dbs.umt.edu>). Division of Biological Sciences, University of Montana. Missoula, MT.
- Rickard, W.H. & Vaughan, B.E. 1988. Plant community characteristics and responses. In *Shrub-steppe: balance and change in a semi-arid terrestrial ecosystem* W. H. Rickard, L. E. Rogers, B. E. Vaughan & S. F. Liebetrau, eds. pp. 109-179. Elsevier Press. Amsterdam.

Richardson, D.M., P. Pysek, M. Rejmanek, M.G. Barbour, F.D. Panetta and C. J. West. 2000. Naturalization and invasion of alien plants: concepts and definitions. *Diversity and Distributions* **6**: 93 – 107.

Roberts, H.A. and R.J. Chancellor. 1988. Seed banks of some arable soils in the English midlands. *Weed Research* **26**: 251-257.

Rossiter, N.A., S.A. Setterfield, M.M. Douglas, and L.B. Hutley. 2003. Testing the grass-fire cycle: alien grass invasion in the tropical savannas of northern Australia. *Diversity and Distributions* **9**: 169-176.

Sax, D.F., S.D. Gaines, and J.J. Stachowicz. 2005. Introduction. In *Species Invasions: Insights into Ecology, Evolution, and Biogeography*, Sax, D.F., J.J. Stachowicz and S.D. Gaines, eds. pp. 1 – 8. Sinauer Associates, Inc. Sunderland, MA.

Silen, R.R. 1955. More efficient road patterns for a Douglas fir drainage. *The Timberman* **56**: 82-88.

Sheppard, A., P. Hodge, Q. Paynter, and M. Rees. 2002. Factors affecting invasion and persistence of broom *Cytisus scoparius* in Australia. *Journal of Applied Ecology* **39**: 721-734.

Swanson, F.J., and M.E. James. 1975. Geology and geomorphology of the H.J. Andrews Experimental Forest, western Cascades, Oregon. USDA Forest Service Research Paper PNW-188.

Tunison, J.T., R. Loh, and C. M. D'Antonio. 2001. Fire, grass invasions and revegetation of burned areas in Hawaii Volcanoes National Park. In *Proceedings of the invasive species workshop: The role of fire in the controls and spread of invasive species*, K.E. Galley and T.P. Wilson, eds. pp. 122-131. Tall Timbers Research Station Publication No. 11, Allen Press. Lawrence, KS.

Tyser, R. and C.A. Worley. 1992. Alien flora in grasslands adjacent to road and trail corridors in Glacier National Park, Montana (U.S.A). *Conservation Biology* **6**: 253-262.

Ullmann, I., P. Bannister, and W. Bastow. 1995. The vegetation of roadside verges with respect to environmental gradients in southern New Zealand. *Journal of Vegetation Science* **6**: 131-142.

Urban, D.L. 2002. Classification and Regression Trees. In *Analysis of Ecological Communities*, McCune, B. and J.B. Grace, pp. 222-233. MjM Software Design. Glenden Beach, OR.

- Witkowski, E.T.F. 1991. Effects of invasive alien acacias on nutrient cycling in the costal lowlands of the Cape Fynbos. *Journal of Applied Ecology* **28**: 1-15.
- Wolf, J. J., S.W. Beatty, and G. Carey. 2003. Invasion by sweet clover (*Melilotus*) in montane grasslands, Rocky Mountain National Park. *Annals of the Association of American Geographers* **93**:531-543.
- van der Meijden, E., and R.E. van der Waals-Kooi. 1979. The population ecology of *Senecio Jacobaea* in a sand dune system. *Journal of Ecology* **67**: 131-153.
- Vitousek, P.M. and L.R. Walker. 1989. Biological invasion by *Myrica faya* in Hawai'i: Plant demography, nitrogen fixation, and ecosystem effects. *Ecological Monographs* **59**: 247-265.
- Vivrette, N.J. and C.H. Muller. 1977. Mechanism of invasion and dominance of coastal grassland by *Mesembryanthemum crystallinum*. *Ecological Monographs* **47**: 301–318.
- Watkins, R., J. Chen, J. Pickens, and K. Brosofske. 2003. Effects of forest roads on understory plants in a managed hardwood landscape. *Conservation Biology* **17**: 413-419.
- Watterson N. and J.A. Jones. 2006. Exotic plant invasion from roads to stream networks in steep forested landscapes of western Oregon. *Geomorphology* (in press).
- Watterson, N. 2004. Exotic plant invasion from roads to stream networks in steep forested landscapes of western Oregon. M.S. thesis, Oregon State University, Corvallis, OR.
- Wemple, B.C., J.A. Jones, and G.E. Grant. 1996. Channel network extension by logging roads in two basins, western Cascades, Oregon. *Water Resources Bulletin* **32**: 1195-1207.
- Whisenant, S.G. 1990. Changing fire frequencies on Idaho's Snake River Plain: ecological and management implications. USDA Forest Service Intermountain Research Station, General Technical Report INT-276, pp. 4-10.
- Wilcox, D. 1989. Migration and control of purple loosestrife (*Lythrum salicaria* L.) along highway corridors. *Environmental Management* **13**: 365 – 370.
- Willard, T.R. 1990. Congongrass (*Imperata cylindrical*) distribution on Florida highway rights-of-way. *Weed Technology* **4**: 658-660.
- Williams, P. A. 1981. Aspects of the ecology of broom (*Cytisus scoparius*) in Canterbury, New Zealand. *New Zealand Journal of Botany* **19**: 31-43.

Wilson, J., G. Rapson, M. Sykes, A. Watkins, and P. Williams. 1992. Distributions and climatic correlations of some exotic species along roadsides in South Island, New Zealand. *Journal of Biogeography* **19**: 183-193.

Windham, L., and J.G. Ehrenfeld. 2003. Net impact of a plant invasion on nitrogen-cycling processes within a brackish tidal marsh. *Ecological Applications* **13**: 883-897.

APPENDIX A

Process Steps in the Creation of a Dynamically Segmented Road Network Layer and Exotic Species Shapefiles

Creation of Distribution Layers

1. Obtained road layer of all roads in the McKenzie River Ranger District from Susan Fritts, Botanist, "Mackenzie_River_Roads.shp".
2. **Used "Select By Attributes" tool to select out only those roads surveyed in 2005 (H.J. Andrews, Deer Creek Drainage, Hwy 126).**
3. Used "Create Layer from Selected Features" tool to make a new layer of 2005 roads sampled, and made this into a shapefile using the "Export Data" command "2005allroadssampled.shp".
4. **Converted "2005allroadssampled.shp" into an ArcInfo coverage "Roadcov1".**
5. Selected arcs for each route, and calculated a value in new Road_ID field.
6. **Used ARCROUTE command to create road route system for exotics based on Road_ID.**
7. Used NODEPOINT command on Roadcov1 to create "Calcover".
8. **Edited the Calcover feature attribute table to add Road_Id and to post a value for each route starting and ending point. "BMP", or beginning point is set to "0" for all roads, and "EndKM" or the end point, is set to whatever length the roads were based on field calculations (and thus should match the survey information in the dbf file).**
9. Used CALIBRATEROUTE to adjust exotic routes on "Roadcov1" to values in Calcover ("BMP" and "EndKM").
10. **In ArcMap, exported "Roadcov1" exotic routes to "ExoticRoutes2.shp", using the "Export data" command.**
11. Saved all survey data (originally in excel file, with Road_ID, "FROM" and "TO" fields to mark each sampling segment) as dbf files ("2005_presence.dbf" and "2005_abundance.dbf").
12. **Used the "Make Route Event Layer" tool by applying event data in 2005_presence.dbf to "ExoticRoutes2.shp"**

13. Used the “Export Data” tool to create shapefiles of 2005 distributions”
“2005_abundance.shp” and “2005_presence.shp”.

Creation of Environmental Attribute Linkage

1. Obtained coverages of elevation (celevhja), aspect (casphja) and precipitation (cprcphja) from Laurie Parendes. These coverages were constructed using elevation, aspect, and mean annual precipitation layers downloaded from the FSL Data Bank and re-coded from continuous variables into categories (see methods section for interval classes). Classes were assigned a “grid code” number, which was added to the attribute table of the coverage. Also obtained a layer of road age and road use (hjaroads) which were derived from the road layer available from the FSL Data Bank and re-coded from exact year (i.e. 1967) to grouping by decadal categories (i.e. 1960). Also downloaded a harvest unit coverage and shapefiles of stream, thermal, and rain gauging stations, and the H.J. Andrews boundary from the FSL Data Bank. (www.fsl.orst.edu/lter). Age of adjacent cut unit was defined as the year of last clearcut, re-coded to a decadal grouping category (i.e. 1960).
2. **Used the “buffer” tool to create 250 m buffers around each of the gauging station points.**
3. Overlaid each environmental attribute with the dynamically segmented exotic species layer, “2005_presence.shp”, as well as the boundary of the H.J. Andrews Forest. Used the “identify” tool to click on each segment of the road network, and noted in a Microsoft Excel worksheet which environmental attributes corresponded to which road segment. The “grid-code” for the buffers was 0 if the road segment was not within the 250 m buffer, and 1 if the road segment was within the 250 m buffer. Only those road segments within the H.J. Andrews boundary were analyzed.
4. **Saved the Microsoft Excel worksheet, which included the road number, the “to” and “from” segment (km) and the “grid code”, or category, for each environmental attribute as a .dbf file, “envr_attributes.dbf”.**
5. Used the “Make Route Event Layer” tool by applying event data in “envr_attributes.dbf” to “ExoticRoutes2.shp”.
6. **Used the “Export Data” tool to create a shapefiles of the nine environmental attributes on the road network, called “envr_attributes.shp”.**